

FREE DEMO DISKS: Ami Pro, Windows Word Processor, Page 101

PC WORLD

AUGUST 1991 \$3.95

WORLD'S EASIEST UPGRADE

1-2-3 FOR WINDOWS

Learn It in a Flash!

SUPER-VGA BOARDS

10 Low-Cost Cards for the Sharpest Color Ever

PERSONAL PRINTERS

50 Affordable Dot Matrix and Ink Jet Workhorses

BARGAIN 286 SYSTEMS

73 Price-Busting PCs!

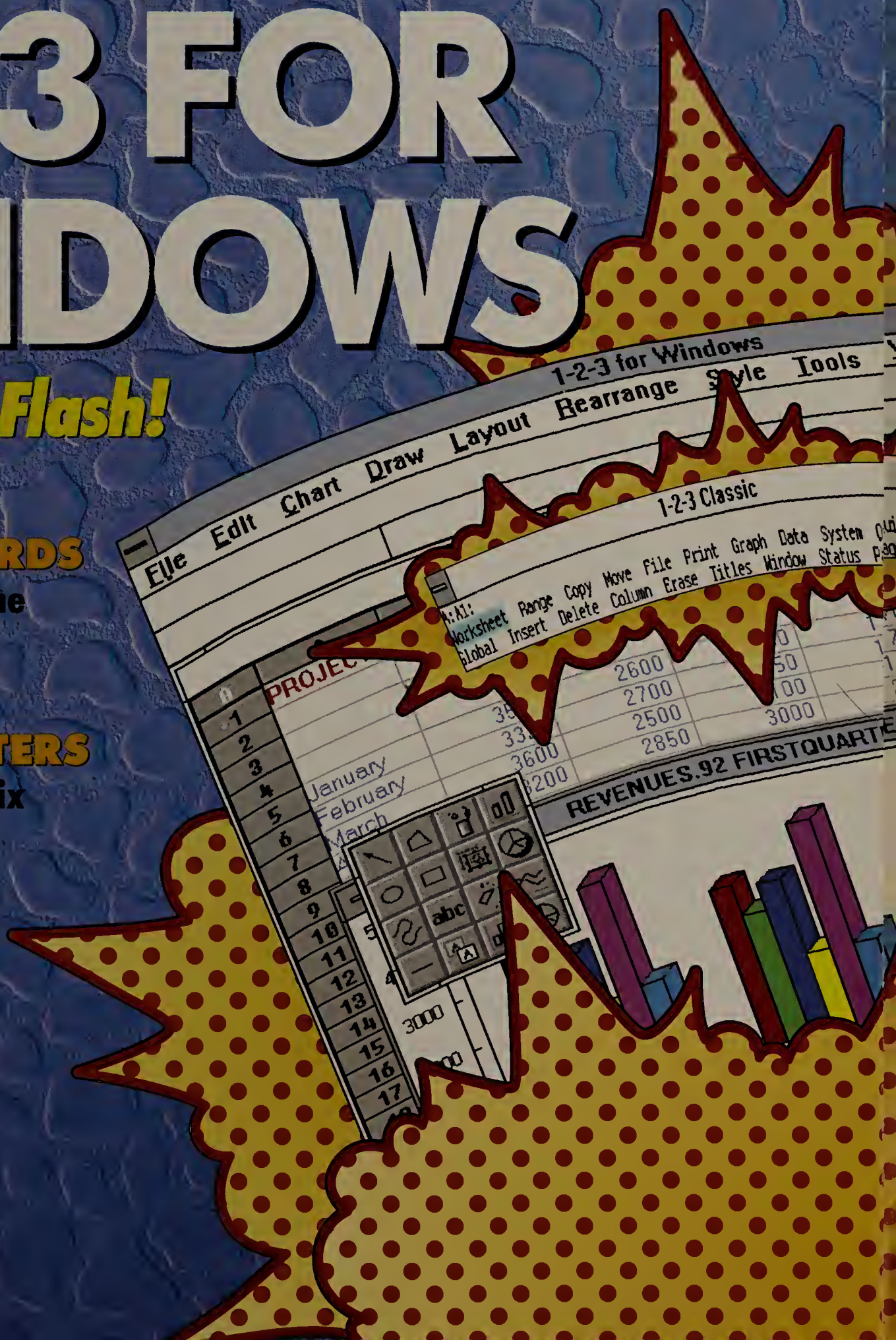

To open. Open.



Circle 187 on reader service card



MultiSync



As the importance of security in
today's environment grows, security
features in the form of integrated
circuit (IC) in the communications
equipment are being developed
to meet the demand. The ICs are
designed to provide a high level of
security of communication. They are
designed to be used in a variety of
communications equipment, such as
mobile communications, satellite
communications, and other
communications. The ICs are
designed to be used in a variety of
communications equipment, such as
mobile communications, satellite
communications, and other
communications.

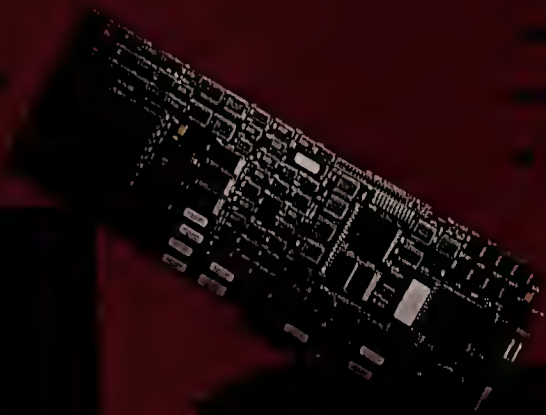

NEC

PC WORLD

COVER STORIES



Windows Special Report
187

PREVIEW

1-2-3 Does Windows It's here! The *Windows* version wraps all the power of 3.1+ in an icon interface that won't quit. And with 1-2-3 Classic menus, current 1-2-3 users will learn it in a flash. **Richard Scoville. 85**

REVIEW

Screen Gems: Super-VGA Boards Sharpen up your favorite application—and add a cornucopia of colors—with one of these low-cost, high-res graphics boards. **TJ Byers. 128**

FEATURES

Buyers' Guide: Personal Printers An inexpensive ink jet or 24-pin dot matrix delivers surprisingly good fonts and graphics and does some tricks even lasers can't. Here are 50 to choose from. **Cathy Smith and Daniel Tynan. 158**

Buyers' Guide: 286 Systems For the price of a good stereo, you can snag a perfectly usable 12-MHz 286 PC for work-at-home computing. Buy a 16-MHz unit, and you can even run *Windows*. **Cathy Smith, Michael Goodwin, and TJ Byers. 168**

WINDOWS SPECIAL REPORT

A PC World Supplement on Windowing Environments and Applications 187

New Windows on Corporate Data
With a *Windows* front end, managers can effortlessly extract vital information residing anywhere on the LAN and integrate it into their own applications. **Sharon Fisher. 189**

InfoAlliance. 196

Forest & Trees for Windows. 199

Q+E. 200

Access SQL. 202

Road Test: Windows 3.0. 206



Screen Gems:
Super-VGA Boards
128

Cover design by Bill Jensen
Cover photograph by David Arky

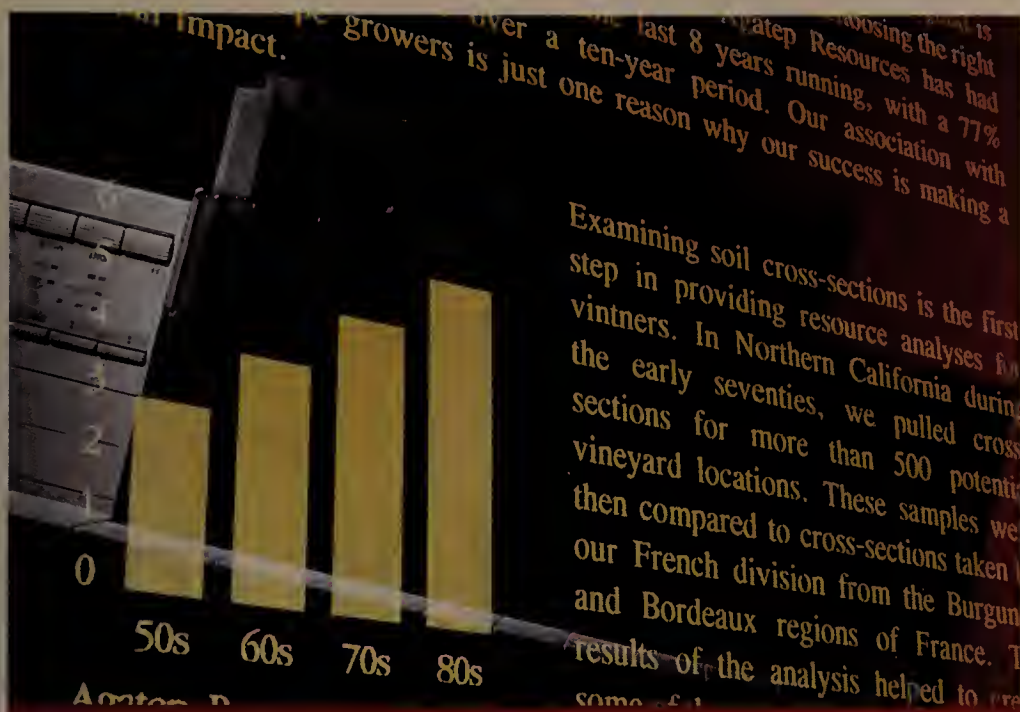

286 Systems
168

Personal Printers
158

INSIDE

NEWS

TOP OF THE NEWS

Mike Hogan..... 15

INDUSTRY OUTLOOK

Cellular phones hooked to notebook PCs create true mobile offices..... 67

Support and stability keep IBM buyers coming back.... 68

Entry-level LANs find homes at small companies... 70

PC World Marketplace: Prices for 30 popular PCs in eight markets, and more.... 72

PRODUCT OUTLOOK

• *The Norton Utilities* Version 6.0..... 107

• *MailMan 1.0*
• *NetWare 2.2*..... 108

• *Picture Packer* • *SBT Database Accounting Library Professional Series*..... 110

• *Visual BASIC*
• *NEC CDR-83*,
Tandy CDR-1000..... 112

• *Datellite 300* • *dBASE IV Server Edition*..... 114

• *Hayes Pocket Edition 2400*
• *Accpac Simply Accounting*..... 116

• *Norton Backup for Windows* • *ZyIndex for Windows 1.0*..... 118

PREVIEWS

Ami Pro 2.0: Lookin' Good

Ami Pro's new word processor is a graphical wonder. See for yourself. Send in for your free demo disks. **Eric Brown**..... 93

One-Stop Windows Shop

PFS: WindowWorks offers the *Windows* software you use most often—in one cozy little package. **Susan Lusty**... 99

Smart Like a Fox

For lightning-fast data management and *dBASE* compatibility, you can't beat *FoxPro 2.0*. **Alan Schwartz**... 103

REVIEW

All-in-One Business Software

If you're a laptop jockey or a new user, low-cost integrated software is the ideal way to go. **George Campbell**..... 147

FEATURES

On Site: Making the Clone Commitment

How a lumber wholesaler trimmed costs and improved customer service with clone-based LANs. **David Rath**... 176

PC Buyers Say Yes to Clones

Clone buyers rate their PCs. **Roberta Furger**..... 182

HOW TO

The Help Screen

Run TSRs under *Windows*, improve 1-2-3's memory management, and more. **Karl Koessel and Robert Lauriston**... 41

Network Q&A

Moving your LAN safely. **Keith Nickerson**..... 47

Create Spreadsheet Reports With Style

Turn your graphical spreadsheet into a potent communications tool. **John Walkenbach**..... 213

Words Into Print

Address letters with your word processor's boilerplate text features. **George Campbell**..... 215

Spreadsheets (A..Z)

What-if analysis with 1-2-3 release 2.2. **Richard Scoville**... 217

Data Basics

Using your data manager's date functions. **Steve Cummings**..... 219

The Art of Persuasion

Color presentations made easy. **Richard Jantz**..... 223

Windows Workshop

Tune up your WIN.INI file. **Jesse Berst and Scott Dunn**... 225

The Information Edge

Is Dow Jones News/Retrieval right for you? **Judy Heim**..... 227

User Group Tips

Hands-on advice from users across the nation..... 229

Star-Dot-Star

List disk space and available memory fast, delete multiple files with one command, and more. **Edited by Brett Glass**... 231

Instant Reference Card

DOS, from basic commands to 5.0..... 237

Developer's Toolbox

Two great programming books. **Brett Glass**..... 243

DEPARTMENTS

In This Issue..... 11

Richard Landry..... 23

Letters..... 29

Consumer Watch..... 49

Two-Fisted Management..... 79

The Home Office..... 288

INFORMATION

PC World Catalog..... 244

Advertiser Index..... 259

Products Featured in Editorial..... 262

PC World Mail-Order Shopping Guide..... 267

Epson Changes The Face

Of Dot Matrix Printing.



The company that set the standard in dot matrix printing, has just raised it. Introducing Epson® ESC/P 2™, a breakthrough printer control language that, for the first time, brings scalable fonts to dot matrix printing.

Now, with ESC/P 2, you can do things with dot matrix printers that before could only be done with lasers. Type sizes are no longer limited. Text and graphics are sharper and more accurate. Moreover, ESC/P 2 runs with any

MS-DOS® computer, and is backwards compatible with virtually every major software application.

ESC/P 2 is now standard in four new Epson dot matrix printers—the LQ-570, LQ-870, LQ-1170 and the ActionPrinter AP-5000. Each comes with a free diskette containing drivers for Microsoft® Windows™, Microsoft Word, WordPerfect®, WordStar® and more.

It's just what you need to take your printing to new heights.

EPSON

Engineered for the way you work.™



LQ-570

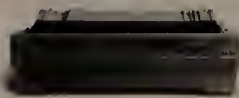

LQ-1170



LQ-870

World's Smallest Portable Mass Storage

**NEW! For IBM Compatibles & Laptops
No Cards Needed!**

Portable r/w Optical

Mac or IBM 128mb per Cartridge



The Liberty Stealth Series R/W 3.5" Optical offers the latest in portable optical storage. Whether your needs are large or small, the security of optical storage is unsurpassed. The Liberty Stealth R/W is a Read/Write Magneto Optical drive with a capacity of 128 Mb on 3.5" removable media boasting a 35ms access time all in a portable package measuring 1.85"x6.8"x9" weighing only 4.5lbs. Plugs directly into the parallel port on IBM Compatibles & Laptops, no interface card is necessary. Also plugs directly into Apple computers.

Portable Hard Drives

Parallel/Printer Port Models



Mac or IBM
Weight: 2.5lbs.
Size: 2"x5"x7"

425Mb

Measuring only 2"x5"x7" and weighing in at only 2.5lbs the Liberty Stealth Series Hard Disk Drives present fast and reliable mass storage. With access times as low as 10ms the Stealth Series Hard Disk Drives are available in sizes ranging from 40Mb to 425Mb. No cards needed for IBM desktops or laptops. Plug directly into Apple computers. Integrated internal power supply.

Portable Removables

44Mb or 88Mb per Cartridge Mac or IBM



With the Liberty Stealth Removable, unlimited Storage is the Key. Whether you require mass storage, backup capability, security, or the plain convenience and reliability of removable disk storage Liberty's Stealth Removable fulfills your needs. At only 1.85"x6.8"x9" and 4.5 lbs. and with 44Mb or 88Mb options at 20ms access times, all your portable data storage needs are met. No cards needed for the IBM desktops or laptops. Plugs directly into Apple computers.

All units have a power supply inside the drive case. A optional international power supply (inside case) is an additional \$50.



(408) 983-1127
Fax: (408) 243-2885

160 Saratoga Ave., Suite 38
Santa Clara, CA 95051

Circle 128 on reader service card

Richard Landry **Editor in Chief,
Associate Publisher**

Eric Knorr **Editor**
Russell Glitman **Executive Editor**

Senior Editors
Reviews Eric Brown
News Mike Hogan

East Coast Editor
Eric Bender

Editorial
Managing Editor Steve Fox
Assistant Managing Editor Cynthia Brown
Technical Editor Karl Koessel
Associate Editors Bronwyn Fryer, Roberta Furger, Michael Goodwin, Daniel Tynan
Assistant Editors Rex Farrance, Matthew Lake, Susan Lusty, Lincoln Spector
Editorial Assistant Cathy Smith

Copy Chief Jane Paulsen
Sr. Copy Editors Barbara Lewis, Peggy Nauts
Copy Editor Marla Miyashiro
Asst. to the Editor in Chief Melissa R. Riofrio
Administrative Assistant John Goddard

Typesetting Manager Mark L. Duran
Typesetter Henry Pham

Business Manager Scott Danish

Art & Design
Acting Art Director Greg Silva
Associate Art Director Robert Kanen
Senior Designer Emily Wollenweber
Senior Design Associates Barbara Adamson, Laura Pannbacker
Design Associate Jeffrey S. Glines
Asst. Designer/Infographics Hope Winslow
Production Artist Marlene Tobias

Contributing Editors
Anita Amirrezvani, Steve Bass, Jesse Berst, TJ Byers, George Campbell, Steve Cummings, Brett Glass, Judy Heim, Mark Henricks, Richard Jantz, Robert Lauriston, Robert Luhn, Carole Matthews, Martin Matthews, Richard Seoville, Ralph Soucie, Scott Spanbauer, John Walkenbach

David Bunnell **Founder**
Andrew Fluegelman **Founding Editor**

User Group Advisory Board
Tony Barcellos, Sacramento PC Users Group; Steve Bass, Pasadena IBM Users Group; Roger Bender, Microcomputer Managers Association (MMA); Jack Bolton, Atlanta PC User's Group; Brian Camenker, Boston Computer Society; Mary Dolce, Chicago Computer Society; Al Harrison, Houston Area League PC Users; David Hoffman, NYPC; Brian Livingston, MMA; Joseph Rigo, NYPC; Irving Samuels, Capital PC User Group; Jerry Schneider, Association of PC User Groups

Patrick Kenealy **President & Publisher**
Richard J. Marino **Associate Publisher**

HOW TO CONTACT PC WORLD

Unless otherwise indicated below, please direct all correspondence and inquiries as follows:

Mail: PC World Editorial
501 Second St. #600
San Francisco, CA 94107
CompuServe: 74055,412
MCI Mail: PC World Editorial
Phone: 415/243-0500
Fax: 415/442-1891

Subscription Services/Address Changes
Call toll-free 800/234-3498 (303/447-9330 in Colorado), or write Subscriber Services, P.O. Box 55029, Boulder, CO 80322-5029. To place new orders, call 800/825-7595.

Letters to the Editor
PC World welcomes your comments and opinions. Address editorial correspondence to *Letters to the Editor*. Letters intended for publication should not exceed one double-spaced page. Be sure to include your name, city, and state. We reserve the right to edit all letters.

Help With Your PC Hardware or Software
If you have a problem, PC World may have the answer. Send written questions about PC products and procedures to *The Help Screen* and network-related questions to *Network Q&A*. Send consumer-related questions and complaints to Roberta Furger, *Consumer Watch*.

Reader Submissions
PC World encourages readers to share technical solutions. We pay \$25 for each *Power Tip* published in the magazine, \$50 for *User Group Tips*, and \$25 to \$200 for *Star-Dot-Star* items. Keep submissions brief (*Power Tips* and *User Group Tips* to 100 words or less). We cannot acknowledge unpublished submissions; accepted submissions will be acknowledged by payment.

New Product Information
Send hardware press releases to Cathy Smith, Editorial Assistant, or call her at 415/978-3179. Send software product announcements to Susan Lusty, Assistant Editor, or call her at 415/978-3321.

Reprints and Permissions
You must have permission before reproducing any material from PC World. If you want to quote from or reprint any portion of any article or use artwork or photographs from the magazine, send a written request to PC World, Reprints and Permissions, 501 Second St. #600, San Francisco, CA 94107; include a phone number to ensure a fast response. To order reprints of PC World, call 415/978-3162.

Editorial Calendars
To receive a copy of PC World's Editorial Calendar, call your nearest regional PC World advertising sales office. See the Advertiser Index for phone numbers.

PC World™ (ISSN 0737-8939) is published monthly at \$29.90 for one year (12 issues), \$59.80 for two years (24 issues), \$89.70 for three years (36 issues) by PC World Communications, Inc., 501 Second St. #600, San Francisco, CA 94107. Foreign orders must be prepaid in U.S. funds with additional postage. Add \$18 per year for Canada and Mexico; add \$46 per year for airmail for all other countries. Canadian GST Registration #R124669680. Second-class postage paid at San Francisco and additional mailing offices. POSTMASTER: Send address changes to PC World, Subscription Dept., P.O. Box 55029, Boulder, CO 80322-5029. Editorial and business offices: 501 Second St. #600, San Francisco, CA 94107, 415/243-0500; CompuServe 74055,412; MCI Mail PC World Editorial. PC World™ is an independent journal, not affiliated in any way with International Business Machines Corporation. IBM is a registered trademark of International Business Machines Corp. Copyright © 1991, PC World Communications, Inc. All rights reserved. The following are trademarks of PC World Communications, Inc.: Consumer Watch, PC World View, *, PC World.



Monitor access or storage is quick and easy.



Monitor arm and platform swivel 360° to any position for greater comfort.



Standard Monitor Arm

Arm and monitor platform swivel 360°, 12 1/4" x 12 1/4" platform holds up to 30lbs. securely. Lifetime Warranty. #MA-1.

\$69.95 ■ Retail

Arm Yourself

Win The Battle For More Desktop Space With Curtis Monitor Arms

Curtis Monitor Arms create more desktop space instantly and improve viewing comfort, reducing eye, neck and back strain.

All three models rotate 360°, providing quick and easy swing-in/swing-out access and storage. The monitor platform accommodates most monitors and is easily adjusted for

Executive Monitor Arm

Arm and monitor platform rotate 360°; 11" x 13" platform tilts 25°, holds up to 65 lbs. securely; retractable keyboard storage rack.

#MA-2 Retail \$139.95



Lifetime Warranty.

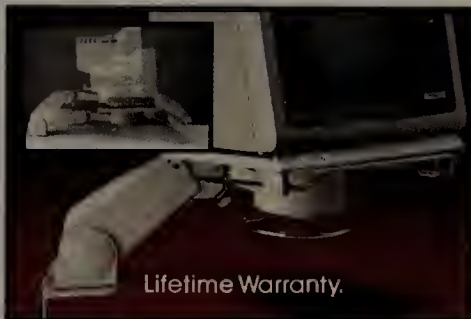

Lifetime Warranty.

improved viewing. They're perfect for shared workstations with your choice of clamp, flange or wall mounting. And all three carry a lifetime warranty. Don't let crowded desktops, tired eyes

and a sore neck defeat you. Arm yourself with a space-saving Monitor Arm from Curtis.

Professional Monitor Arm

8-axis design provides infinite adjustable elevation and 360° rotation; 11" x 13" platform tilts 25°, holds up to 65 lbs. securely; retractable keyboard storage rack tilts 30° for more comfortable use. #MA-3 Retail \$239.95

Curtis products are available worldwide. For more information call (603) 532-4123 Ext. 40.

WANT TO SAVE THOUSANDS ON A DELL COMPUTER?

BUY AN AUSTIN.



\$7495

THE AUSTIN 486/33 EISA WINTOWER

INTEL 486¹/33MHZ PROCESSOR, EISA
BUS ARCHITECTURE, 330MB HARD DRIVE,
4MB RAM, 128K EXTERNAL CACHE, VGA
MONOCHROME MONITOR



\$9649

THE DELL 433TE

INTEL 486¹/33MHZ PROCESSOR, EISA
BUS ARCHITECTURE, 330MB HARD DRIVE,
4MB RAM, 128K EXTERNAL CACHE, VGA
MONOCHROME MONITOR



AUSTIN 386/SX16 WINSTATION
\$1790

Microprocessor: 386/SX running at 16MHz
Special Features: Pre-loaded with Microsoft Windows 3.0, MS-DOS 4.01 and a Microsoft mouse
Storage: 40Mb IDE hard drive
Memory: 2Mb RAM
Video: 14" VGA color monitor with 16-bit VGA color video adapter. Other options available. Call for details.



AUSTIN 386/SX20 WINSTATION
\$1890

Microprocessor: 386/SX running at 20MHz
Special Features: Pre-loaded with Microsoft Windows 3.0, MS-DOS 4.01 and a Microsoft mouse
Storage: 40Mb IDE hard drive
Memory: 2Mb RAM
Video: 14" VGA color monitor with 16-bit VGA color video adapter. Other options available. Call for details.



AUSTIN 386/25 WINSTATION
\$2390

Microprocessor: 386 running at 25MHz
Special Features: Pre-loaded with Microsoft Windows 3.0, MS-DOS 4.01 and a Microsoft mouse
Storage: 85Mb IDE hard drive
Memory: 2Mb RAM
Video: 14" VGA color monitor with 16-bit VGA color video adapter. Other options available. Call for details.

1991 Austin Computer Systems. All Rights Reserved. Dell is a registered trademark of Dell Computer Corporation. Pricing based on Dell Computer Corporation ad, PC Magazine, May 14, 1991 issue. Other product names or trademarks shown herein are for illustrative purposes only and may be the property of other companies. Prices and specifications are subject to change without notice. Austin Computer Systems cannot be responsible for errors in typography or photography. There is no annual fee or minimum charge required for the Austin Computer Systems credit card and the annual percentage rate is 17.64% in Texas and 17.88% in all other states. Ad Code PW-0891



AUSTIN 386/33 WINSTATION
\$2990

Microprocessor: 386 running at 33MHz
Special Features: 128K system cache. Pre-loaded with Microsoft Windows 3.0, MS-DOS 4.01 and a Microsoft mouse
Storage: 85Mb IDE hard drive
Memory: 4Mb RAM
Video: 14" VGA color monitor with 16-bit VGA color video adapter. Other options available. Call for details.



AUSTIN 486/25 WINSTATION
\$3990

Microprocessor: Intel 486™ running at 25MHz
Special Features: Internal 8K cache, Microsoft Windows 3.0, MS-DOS 4.01 and mouse,
Storage: 125Mb IDE hard drive with 32K cache
Memory: 4Mb RAM (expands to 32 Mb)
Video: 14" VGA color monitor, with 16-bit VGA color video adapter. Other options available. Call for details.



AUSTIN 386/SX16 NOTEBOOK
\$2295

Microprocessor: 386/SX running at 16MHz
Special Features: Under 8 lbs. with battery. Up to 7 hour battery life, battery and recharger included
Storage: 20Mb hard drive, 1.44Mb floppy disk drive
Memory: 2Mb RAM
Video: Brilliant 10" VGA LCD display with 640 x 480 resolution and 32-gray scale
Keyboard: Full size embedded numeric pad with 12 function keys. Other options available. Call for details.

TO ORDER CALL:
1-800-833-3657

VAR 1-800-338-1569 OVERSEAS (512) 339-3500
 GOVT 1-800-833-4472 NETWORKING 1-800-874-7182
 FAX (512) 454-1357 CANADA 1-800-338-1565
 CORPORATE ACCOUNT 1-800-622-5506

IN A RUSH? WE CAN SHIP OVERNIGHT OR NEXT DAY AIR
 ALL TIME ZONES MON-FRI 7AM-7PM SAT 10AM-5PM

AUSTIN'S AWARD-WINNING COMPUTERS HAVE COMPONENTS LIKE INTEL, MITSUBISHI, SEAGATE, MICROSOFT, AND KEYTRONICS. JUST LIKE DELL. AUSTIN HAS TOLL-FREE PHONE SUPPORT, NEXT-DAY ON-SITE SERVICE, 100% FINANCING, LEASE OPTIONS, AND A 30-DAY MONEY-BACK GUARANTEE. JUST LIKE

DELL. BUT DELL CHARGES YOU HUNDREDS, EVEN THOUSANDS OF DOLLARS MORE FOR THE SAME PERFORMANCE AND FEATURES. JUST LIKE COMPAQ. **AUSTIN COMPUTER SYSTEMS**



Circle 14 on reader service card

The Bulk Of Relational Databases vs. The Brains Of New Q&A.

Introducing Q&A 4.0

Everywhere we turn, businesses are trimming the fat. Bulk is out. Brains are in. The same holds true for databases. For years, instead of bulky over-engineered, and frequently overpriced relational databases, smart business people have chosen Q&A.™ And now with the power and programming tools of new version 4.0, Q&A is quite simply the better choice.

For everybody.

Q&A 4.0 can help you create powerful database solutions faster than with a relational database. And without all the hassle. For example, Q&A can now directly access data from external Q&A or dBASE databases, and post to external databases as well. Q&A 4.0 is compatible with all the major data and word processing standards,* and with the appropriate links, can even bring in data from



SQL tables. For those of you who need to create sophisticated databases for others, new Q&A includes a complete set of Application Programming Tools that simplify the process and offer powerful shortcuts. And it has full network support for maximizing workgroup productivity.

Yet, for all its new power, version 4.0 is as easy as ever, so it's just right for your everyday business needs. You'll use Q&A 4.0's Query

Guide to quickly build database queries using English phrases and to produce hundreds of flexible reports. And its integrated word processor with page preview and expanded mail merge will help you instantly generate professional-looking form letters and mailing labels.

To see how Q&A 4.0's power can help you, call for our free demo disk.** You'll see why companies that put productivity first like Ameri-

can Express and PepsiCo have been using Q&A for years. If you're tired of excess database baggage and are interested in doing more with less, do something really smart.

Call right now.



Free Demo Disk,
(800) 228-4122 Ext. 104-P
Upgrade Info: (800) 228-4122 Ext. 101;
(800) 465-2266 in Canada

SYMANTEC.

Symantec Corporation, 10201 Torre Ave., Cupertino CA 95014. (408) 253-9600.

*dBASE, Paradox, Professional File, Lotus 1-2-3, WordPerfect, Word, WordStar, MultiMate and Professional Write. **Offer limited to North America. Outside North America call (408) 252-3570 for your local Symantec office or distributor. Q&A is a trademark of Symantec Corporation. Other brands and products are trademarks of their respective holders. © 1991 Symantec Corporation

Circle 279 on reader service card

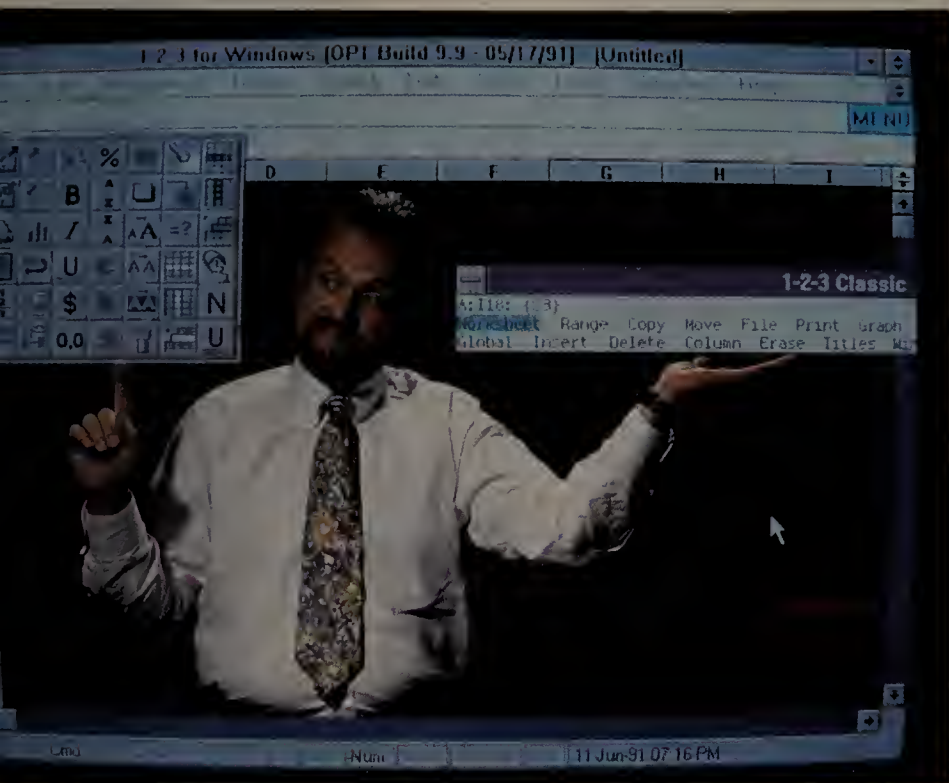

Spreadsheet columnist Richard Scoville gets the feel of 1-2-3 for Windows.

The greatest minds in software have done some serious cogitating. After months of research, roundtables, and overheated brain work, they've reached an earth-shaking conclusion: You'd rather push a button than pull down a menu.

Those comely, 3-D-looking buttons made their debut in *Windows 3.0*. But when they cropped up in *Excel 3.0*, we learned that buttons are more than cosmetic.

The idea is simple. For example, to pick the SUM function using *Excel 3.0*'s standard menus, you have to pull down a menu, bring up a dialog box, and scroll through a list of functions. Using *Excel 3.0*'s button-filled tool bar, one click on the SUM button is all it takes. Buttons for creating charts, drawing lines, and changing text formats also save you from needless mousing around. That's why our spreadsheet columnist, Richard Scoville, grants *Excel 3.0* "the hands-down prize for most usable spreadsheet interface."

In this month's cover story, Scoville looks at *1-2-3 for Windows* and discovers that *Excel 3.0* has some serious competition. *1-2-3 for Windows* takes the button idea a step further: You create your own panel of buttons—Lotus calls it an "icon palette"—from a selection of 70 icons, each of which calls up a program function.

The icon palette makes *1-2-3 for Windows* one of the first programs to let you build your own user interface quickly and painlessly. If you do a lot of budgeting, you can mix in a large proportion of formula-linking and worksheet-consolidation buttons. If your job entails ad hoc analysis, you can swap in a full array of graphics

Button-Down Thinking

buttons. Once you've created your personal palette, you can resize it and place it anywhere on screen.

Of course, buttons alone don't make an interface. Scoville maintains that *1-2-3 for Windows* can't match *Excel 3.0*'s many niceties—such as the ability to double-click on any object and have a dialog box pop up automatically. And for many *1-2-3* veterans, *1-2-3 for Windows*' old-fashioned 1-2-3 Classic menus—still available as an option—may appeal more (at least at first) than any number of mix-and-match buttons. Even so, *1-2-3 for Windows* marks a big step toward software that works the way you do. In the future, expect more *Windows* programs that take the "have it your way" approach.

This issue of *PC World* sets its own milestone in putting the user first. A new regular feature called *Road Test* gives normal folk—rather than us ivory-tower editors—the opportunity to say what they think about software and hardware. This month, on page 206, six users sound off about *Windows 3.0*.

In another move to help us all remember whose opinions matter most, we've made a small but significant addition. From now on, in all reviews and Buyers' Guides you'll find an icon next to every product that's won a World Class Award in the past two years. Each year readers vote for the top products in dozens of categories; now you'll be able to see the past winners at a glance—and take readers' recommendations into account as you decide which product will be best for you.

Finally, this month's *Consumer Watch* column presents our annual user group list. When you shop for hardware and software or need help in using the stuff you already have, there's only one way better than reading *PC World* to get the information you need—contact the user group nearest you. ☺

Eric Knorr
Editor



Make your ideas fly



before their very eyes.



With business animation.



Choose from 32 color palettes. Then shade. And mix. And blend.



160 charts ready-to-go.



Fill it with bitmaps.

Coffee Table Books Semi-Annual Sales

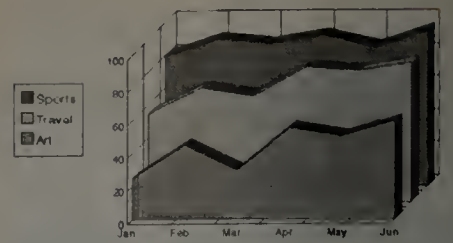

Source: Picture Book Magazine, Fall Issue

What you see is what you get.

ACMESHOE.CH3		KY Chart	
F1-Help		F2-Show chart	
F6-Main Menu		F7-Spell/Text	
Title:	Acme Shoes	Title:	
Subtitle:	Quarterly Sales	Text:	
Footnote:	Our company has sole	Appar:	
		Font:	
Data Pt	X Axis Name	Qua	Style
1	Loafers	240	Series
2	Sneakers	350	Axis fr
3	Wingtips	390	AXIS OR
			Format
			Data stah

Pull-down menus: A new feature to get at the

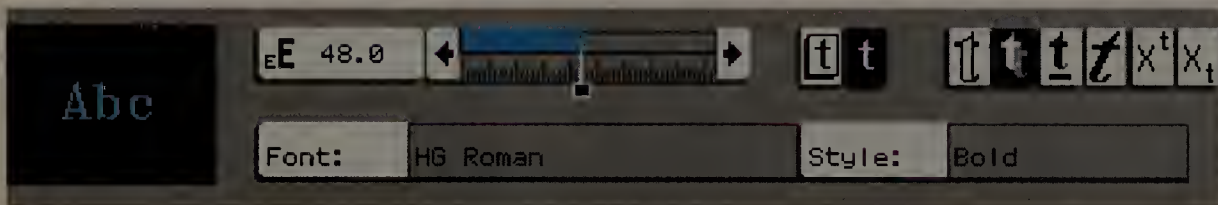

Underline. Bold. Outline. Italicize. Do what you will with our new Bitstream* typefaces.

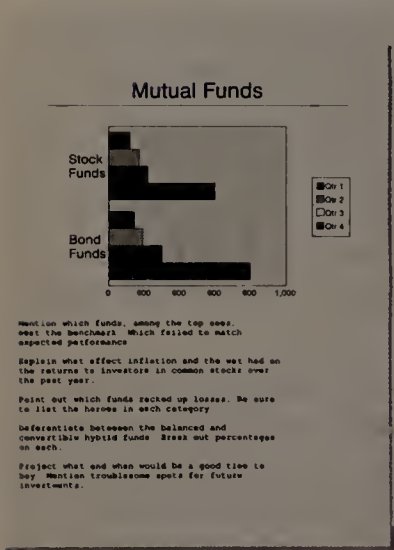

A reminder: We have speaker notes.

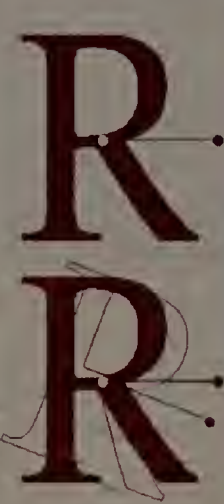

Twist it. Turn it.

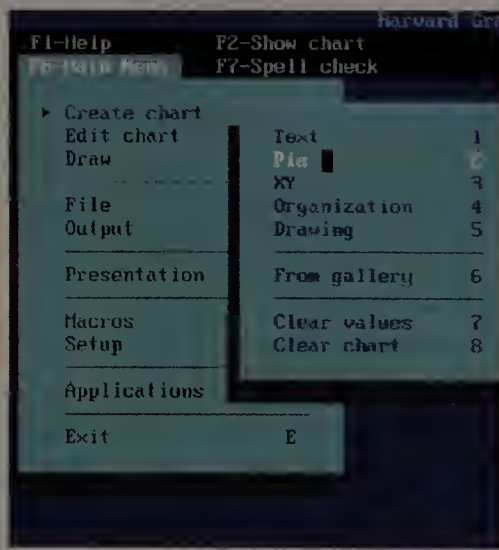

Look familiar? It should. It's Harvard Graphics.

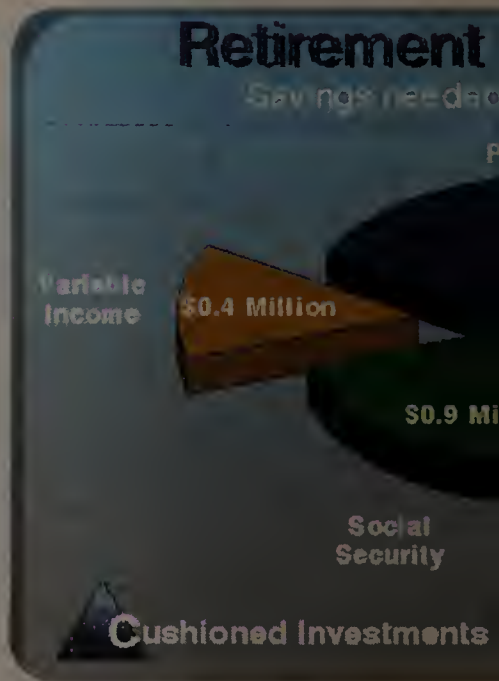

You enter the data, we'll make it look good. It's

Overwhelming evidence is more than just

Our new DOS upgrade is loaded with features. Call 1-800-336-8360, Operator 753, for your \$125. Harvard Graphics users can order 3.0 by calling 1-800-548-4772. Harvard Graphics 3.0 is a registered trademark of Software Publishing Corporation. Bitstream is a registered trademark of Bitstream, Inc.

Coffee Table Books
Semi-Annual Sales

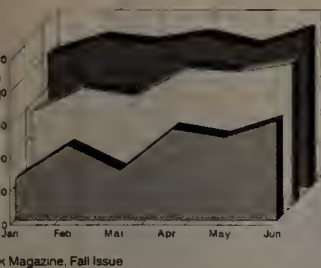

Yes, we have WYSIWYG.

Draw	F5-Mark
XY data	F10-Continue
1 Ctrl-T	
2	
3	
4 Ctrl-N	4
5	Quarter 4
6	39000
7	48000
8	4500
9	
A	
B	

features. Easier than ever.

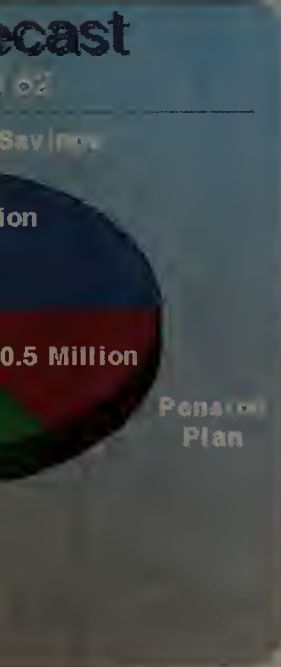

what you've known us for all along.

- Delete
- Duplicate
- Copy
- Paste
- Symbol
- Edit txt
- Align
- Space
- Flip
- Rotate
- Skew
- Front
- Back

Drawing tools. 39 in all.

Top Recycling Centers
1991 Comprehensive Study

	Minnesota	San Francisco	Portland
Cover	\$700,000	\$1,200,000	\$400,000
Glass	\$200,000	\$2,500,000	\$200,000
Paper	\$1,000,000	\$800,000	\$873,000
Plastic	\$200,000	\$125,000	\$213,000

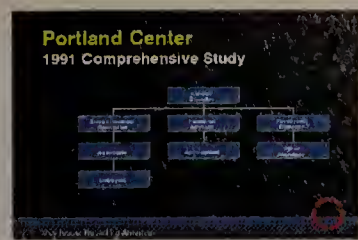

From titles to footnotes. From colors to logos. Our global options keep it consistent.

Controlling Pollution in Industrial Parks
Air, Water, and Land

- The dollars committed to cleaning up pollution are awesome.
- Every time a factory goes unchecked, it costs more than \$1 million in clean up.
- Government guidelines need to be tightened.

Do what you've always done before...

Controlling Pollution in Industrial Parks
Air, Water, and Land

- The dollars committed to cleaning up pollution are awesome.
- Every time a factory goes unchecked, it costs more than \$1 million in clean up.
- Government guidelines need to be tightened.

... style it like you've never seen before.

View Lotus Worksheet

Current location: C6, D8: 56

	A	B	C	D	E	F	G	H
1	Sales Rpt							
2	In mil \$							
3								
4				1991			1992	
5	Quarter	Q1	Q2	Q3	Q4	Q1	Q2	
6	Cost			30	18	26	30	
7	Gross Rev			77	58	82	77	
8	Net Rev			47	40	56	47	
9								
10	Tot Gross	286			Net x	68.53		
11	Tot Cost	98			Cost x	31.47		
12								
13	Total Net	196						

We heard you. Now you can view and select directly from your spreadsheet.

Fill

Line/Text

Pattern

Shadow

Chart colors

Bkg

None

Custom colors

White

Patterns

How do 16 million colors sound?

that Harvard Graphics® 3.0 another upgrade.

own demo disk. And view the evidence yourself.

SPC SOFTWARE PUBLISHING CORPORATION

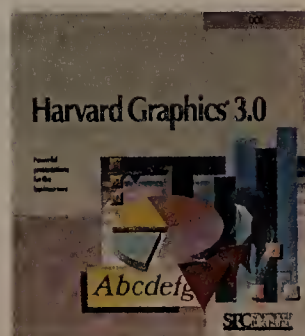

**“We launch
1000 shuttle trips
every day with
our LANtastic
network.”**

—John Kindt, President,
Prime Time Shuttle, Sun Valley, CA



ARTISOFT SHATTERS THE MYTH!



For more information call Artisoft at (602) 293-6363,
or visit your Artisoft Authorized Five Star Dealer.



© 1991 by ARTISOFT, Inc. All rights reserved. LANtastic is a trademark of Artisoft, Inc.

On a normal day, Prime Time Shuttle makes 1,000 trips from four Los Angeles airports, one AMTRAK station, and the San Pablo Harbor, via LA's notorious freeway system, to homes and offices in four Southern California area counties.

At any given moment Prime Time Shuttle has 60 to 90 vans on the road. They track every flight so they know when each passenger arrives. They promise service within 15 minutes of the reservation or the ride is free, a promise they keep 97% of the time.

How do they do it? Back at headquarters, computers are taking reservations, verifying credit card charges, blocking reservations to assign to drivers, tracking the vans along the highways, recording the drivers' commissions as they are earned, and updating management with constant progress reports.

Kory Washburn is the assistant manager of Prime Time Shuttle who set up the computer system. He started December 23, 1990 with one dispatcher's computer. Now he's running 30 machines on a

LANtastic Ethernet system, and expects to add a new computer to the system every week until they reach 50 nodes.

He chose LANtastic because of the flexibility of its peer-to-peer structure. "Instead of a single overloaded server, we broke down the tasks, spread them over multiple servers and still fully interconnect the system with cheapernet cable."

Washburn praises Artisoft hardware and LANtastic software compatibility with other manufacturers' cards and systems. "You can't beat the price. And the speed is incredible, especially the way we abuse the system," he confessed.

"Artisoft tech support stuck with us until they solved our problems. They were great."

There's a myth that LANtastic is only suited to small, simple systems. But next time you need a ride from LAX, remember LANtastic is the Prime Time network.

ARTISOFT
Revolutionizing Connectivity

Circle 18 on reader service card

MIKE HOGAN

IBM Debuts 386SX PS/2s

AT and MCA Buses Get Equal Billing

The last major vendor to offer desktop PCs with a 20-MHz 386SX chip, IBM launched three such machines in June—including two with the AT bus that Big Blue has been trying to squelch for the past four years.

The new Models 35 SX and 40 SX are in IBM's best-selling segment and will compete with Micro Channel architecture alternatives. Some analysts see this as a strategic retreat from the MCA bus—a suggestion IBM executives deny. AT-bus PS/2s are for personal productivity—primarily DOS applications—while MCA-based PS/2s are corporate machines suited for OS/2 networks, says David Thomas, president of IBM's National Distribution Division.

Pricing "is competitive with Compaq and within striking distance of AST and Dell," notes International Data Corporation analyst Bruce Stephen. Even the high-end MCA-based Model 57 SX provides more value than previously offered by the two-year-old 55 SX, the world's best-selling PC. For \$3625, the 57 SX buyer gets more slots and more storage as well as a new 2.88MB floppy drive, 16-bit VGA, and a SCSI controller on the motherboard. A comparable AT-bus-equipped Model 40 SX will run DOS applications just as fast for \$430 less, but the standard configuration has less memory, a 1.44MB floppy, and no SCSI controller.

IBM Improves Its Number One PC



PS/2 Model 55 SX

- 16 MHz
- 2 bays
- MCA bus
- 1.44MB floppy
- 3 slots
- \$2745

Model 57 SX/Model 40 SX

- 20 MHz
- 4 bays
- MCA/AT bus
- 2.88MB/1.44MB floppy
- 5 slots
- \$3625/\$3195

Successors to IBM's hot 55 SX are faster and more expandable and offer an MCA or AT bus.

A smaller, 40MB AT-bus version, the 35 SX, lists for \$2525. And memory and storage have been upgraded on the veteran \$2745 Model 55.

Thomas insists that for equivalent systems, "there is no premium for the Micro Channel." Even so, IBM needs to give users a reason to choose MCA over the AT standard, analysts say. That reason could be the powerful OS/2 2.0 due this fall.

TrueImage/TrueType Push On

Microsoft's printing business has been reorganized after the resignation of a key executive, but observers say Microsoft remains on track to deliver the TrueType on-the-fly font generator and TrueImage page description language it has promised. In fact, recent changes may hasten the advent of technology that could let users print from *Windows* up to ten times faster than from DOS-based applications, says BIS Strategies International group director Rob Auster. Although this "fast-path" printing is many months away, Microsoft is expected to eventually provide TrueImage printer vendors with display code that will greatly speed the translation of *Windows* files into TrueImage pages.

Microsoft's PostScript-cloning ambitions have been curtailed since September 1989, when it teamed up with TrueType font provider Apple

Computer to compete with Adobe. Apple has since put TrueImage on the back burner, and this June Microsoft TrueImage development head Cal Bauer departed.

"But the bottom line is that we will continue to work on TrueImage," says Microsoft unit general manager Steve Shaiman, who has recast Bauer's Printer Business Unit into a *Windows* support group.

While printer vendors blame Microsoft for continued delays in TrueImage printer shipments, they add that recently released code is stable and will result in fall deliveries. TrueType font scaling has been unaffected by the delays, but this technology won't be truly useful until it's incorporated into *Windows 3.1*, due around year-end. Then on-screen display will become virtually identical to the printed page, and the stage will be set for fast-path application printing.

NCR, Grid Offer Notepad Blueprint

Not this down: By year-end, at least half a dozen vendors will ship notepad PCs, and some analysts expect as many as 300,000 of these powerful pen-based systems to be sold in 1992. By summer's end, slate-like systems from NCR and Grid Systems will offer a blueprint of the genre.

Grid plans two 4.5-pound units running at 9.5 MHz—one with a 20MB hard drive and a 1MB RAM card slot, the other with two RAM card slots. Since hand-held devices must be even lighter than notebooks, storage capacity will be limited at first. But 40MB to 80MB drives should

be common by mid-1992, and 500MB drives are envisioned for 1996.

NCR's 3125 Notepad is more representative of the size and power needed for notepads. At 3.9 pounds and with 20-MHz power, the 3125 lets you walk and do *Windows* at the same time. That's important since all entrants rely on Microsoft's *Pen Windows* and/or Go's *PenPoint* as the enabling platforms for compute-intensive handwriting recognition. Also, the way NCR implements Intel's low-power 386SL could yield up to 6 hours of nonstop use.

Working outside an office

under varying light conditions requires at least a backlit VGA display and built-in communications. The 3125 has an optional 2400-baud modem, but expect that to be surpassed by faster offerings next year. Also, while true notepads offer character recognition, even the best boast accuracy of only 98 percent—and that's for block-letter writing. So look for keyboard options to augment notepads.

While Grid's offerings can be had for under \$3600, the price tags of \$4600 to \$6700 on NCR's six pen-based configurations are more representative. That may seem pricey, but NCR estimates there are some 20 million potential notepad users.

Microsoft Ups Support

Admitting that Microsoft's resources were overwhelmed by the surge of *Windows* users, Chairman Bill Gates promises to expand *Windows* tech support through staff increases, road shows, and software enhancements.

After years of lukewarm *Windows* sales, 4 million copies of *Windows 3.0* were sold during the year following its May 1990 debut. *Windows* application sales tripled to \$400 million even though DOS-based leaders weren't yet rewritten for the environment.

Windows Support Expands

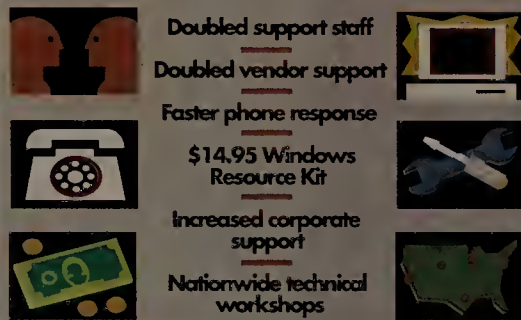

Surge in *Windows* support calls has Microsoft spending millions to improve its response.

Microsoft doubled tech staff to 600 to meet all the support calls—many for simple installation problems.

"Virtually all of these are avoidable," asserts Gates, who figures better developer tools and "literally thousands of improvements" in *Windows 3.1*

will cut the initial load in half when *3.1* ships around year-end. A new \$14.95 *Windows Resource Kit* offers a variety of utilities and tips on how to avoid the most common *Windows* problems.

But general manager of product support Patty Stonesifer expects new titles such as *1-2-3 for Windows* and *Word-Perfect for Windows* to keep help requests high. She promises to double end-user tech staff again if necessary and increase the number of developer and corporate support coordinators to whatever level is needed.

Stonesifer claims Microsoft has reduced the phone wait to

under a minute for 85 percent of callers, but Gates insists all calls be answered in less than a minute. Bill Lodge, corporate systems analyst for New York City's Turner Construction, says he no longer experiences the 10-minute waits of last spring, but "they still have a little ways to go."

Microsoft also plans a series of technical seminars throughout the nation and is examining ways to leverage the support efforts of other *Windows* vendors. These programs cost millions of dollars, says Stonesifer, but cost isn't a showstopper since *Windows* revenues are increasing faster than the phone calls.

IBM Sets Superfloppy Standard

IBM's long-awaited announcement of a floppy disk drive with 2.88MB of usable capacity virtually guarantees that the "superfloppy" will become the next media standard, say observers. Backwardly compatible with lower-capacity 3½-inch drives, superfloppies should appear at least as options on numerous PCs by COMDEX Fall and on nearly all PCs by early next year.

IBM had hoped to introduce the drive last year but waited for the June shipment of DOS 5.0, which recognizes the format without other drivers. Drive and media makers have long been tooled up and ready to supply the 580,000 drives Jim Porter, president of Disk/Trend, estimates the market will need this year, as well as the 1.2 million he predicts will ship in 1992.

By 1993 the 2.88MB capacity will constitute 7 percent of the 35 million microfloppy drives shipping—a relatively

quick penetration. While the 3½-inch microfloppy was introduced in 1982, it wasn't until 1987 that IBM chose that form factor over other options. Microfloppy shipments passed 5¼-inch drive shipments a year later.

Porter anticipates an initial price premium of \$15 to PC makers and \$25 to end users, relegating the 2.88MB format first to high-end machines. But since it costs only \$3 more to make a 2.88MB drive, the premium will be short-lived, predicts Gene Dougherty, director of sales and marketing at Toshiba America's media and recording division, which holds the primary patents on the 2.88MB recording technique and its barium-ferrite media (disks will cost \$10).

Despite talk of PC makers leaping to 20MB-plus floppies, IBM's decision and higher costs will relegate higher-density drives to backup duties for a while, says Porter.

50-MHz 486 Lines Up Against RISC

The 50-MHz version of Intel's 486 chip—the next plateau for PC power users and a major weapon in Intel's struggle against Reduced Instruction Set Computer (RISC) chips—has arrived. Well, almost. While both chip and systems based on it debuted in June, Intel won't deliver the 486/50 in quantity until the fourth quarter.

Like its slower compadres, the 486/50 is a high-powered 386 superset with 8K of cache and an integrated math coprocessor. It is priced fairly aggressively at \$665, considering that a 486/33 costs manufacturers \$445.

As it did with the 486/25, IBM became the first vendor to unveil a product based on the new chip: a processor swap-out for XP models that should boost system prices past \$15,000. By ship time, expect just as many 50-MHz PCs from Compaq, Dell, and others. All will carry a hefty price premium and appeal initially to a small handful of users running client-server network applications, CAD packages, and other CPU-

hungry software.

That means Intel is throwing its new champion up against the RISC onslaught, notes Computer Intelligence analyst Dan Ness. In fact, the 486/50 beats the market-leading Sparcstation 2 in some benchmarks and "will be very competitive against all comers," promises Intel marketing manager Tim Keating.

Intel "has been able to keep up with RISC processors in integer performance, but it's somewhat behind in floating-point," notes Michael Slater, editor of the *Microprocessor Report*. He expects RISC chips shipping later this year to be significantly faster and predicts Intel's next play in this power game will be the 586 rather than a faster 486.

While most 486 machines remain specialty items, Keating points out that a million have shipped to date, and Intel expects to double that by year-end. But most new sales will be of relatively inexpensive 486SX PCs, says market researcher Instat, which predicts shipments of only 10,000 486/50 PCs this year. ●



**Because
some things in life are
more important than
your computer...**

CompuAdd gives you more



quality time.

What's important is what your computer makes possible.

"I have some projects that are so big — 200 or 300 pages long — that I couldn't keep track of all the pages and all the correspondence without a computer," says Bill Hendrick, who uses a CompuAdd 320 in his job as an international regional manager. For Hendrick, getting work done quickly and efficiently is an everyday CompuAdd benefit. "So I can spend my free time with my family," he says. "We have a 3-year old, a 2-year old and an infant — and we spend a lot of time going to the park, on picnics and doing all kinds of outdoor things."

Forget about computers. Concentrate on what's important to you.

"I've always been impressed with the speed of CompuAdd's service — both when you're trying to decide what to buy and later, when you need technical help," says Steve Elmendorf. Now that a CompuAdd 325 is busily turning out quotations and proposals, floorplans and cost analyses for the medical x-ray business where he is district manager, Elmendorf finds the computer's speed makes a huge difference, too. "I can get things cleared up at work and not have to carry it home with me," he adds.

Computers aren't what's important, they're a means to an end.

"Medicine's about people, so I want to spend as much time with my patients as possible. That's why I use my CompuAdd computer for patient records and history. It's terrific," says Dr. A.L. Exline. "It's quicker and cheaper than dictating and having it typed." Getting away from paperwork faster also gives Dr. Exline more time with his grandchildren. "When I can have a family outing that includes fishing," he says, "well, I can't think of a more enjoyable way to spend my time."

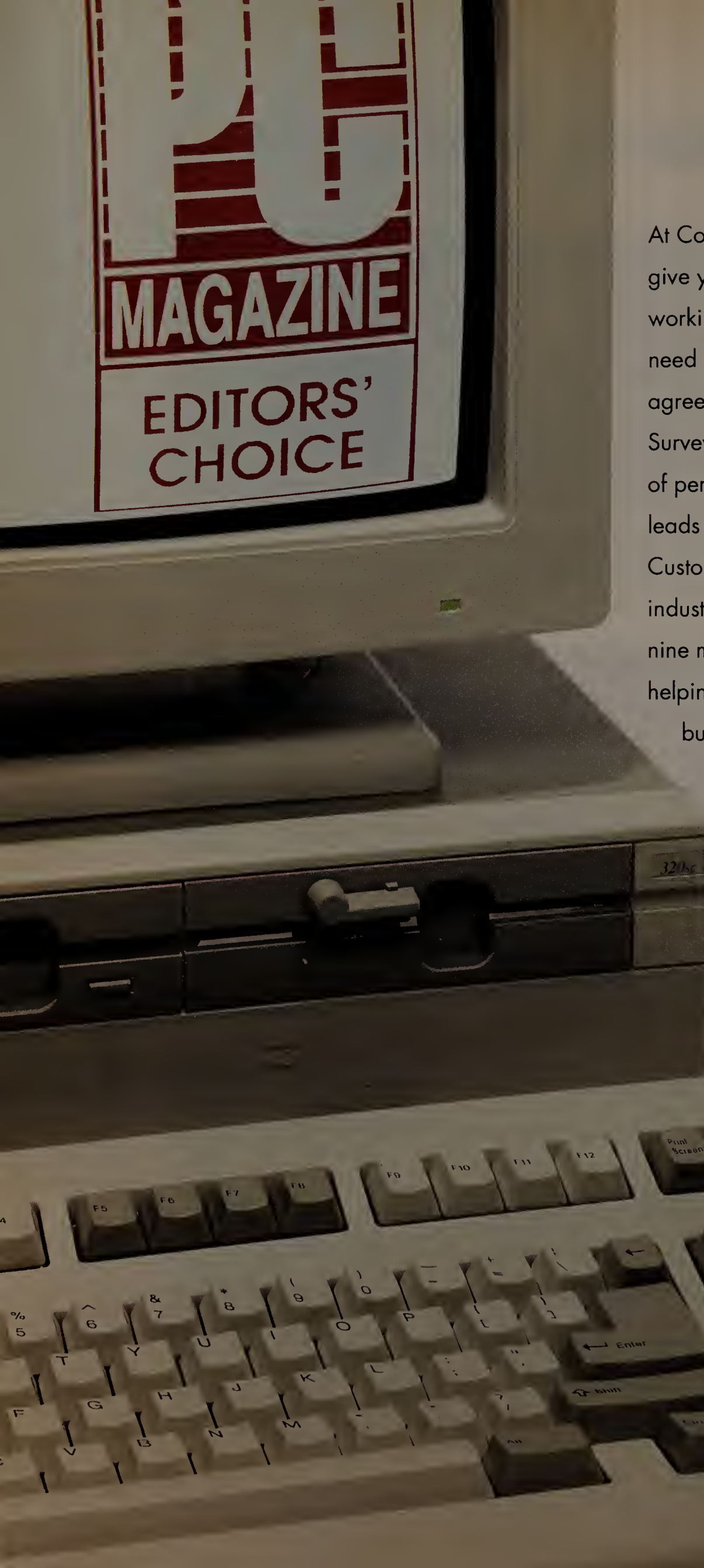

We build a

At CompuAdd, we know the best way to give you quality time is to design hard-working systems and to be there when you need service and support. And our customers agree. In fact, according to the Dataquest Survey, the authoritative, independent poll of personal computer customers, CompuAdd leads the entire PC industry in Overall Customer Satisfaction. And we've set the industry's customer satisfaction standard for nine months running. We're serious about helping you make a success of your business. And we have the satisfied customers to prove it.



family of quality computers.



CompuAdd 316nx

- 80386SX rated at 16MHz
- 1MB DRAM expandable to 5MB
- 30MB (23ms) hard drive
- 3.5" 1.44MB diskette drive
- 8.5" diagonal mono VGA display
- 80-key keyboard/101 key emulation
- CompuAdd MS-DOS 4.01
- 7 lbs; 11" x 8.5" x 2.1"

\$2495 (62302)



Systems pictured with options

CompuAdd 320sc

- 80386SX rated at 20MHz
- 2MB DRAM expandable to 32MB
- 32KB cache memory
- 40MB hard drive
- High-Resolution color VGA monitor
- Three full-sized 16-bit and two half-sized 8-bit slots
- One 5.25" and two 3.5" half-height drive bays
- CompuAdd Windows 3.0

\$2245 (66912)



CompuAdd 325

- 80386 rated at 25MHz
- 4MB DRAM expandable to 16MB
- 40MB hard drive
- Monochrome monitor
- Cache controller with 32KB SRAM
- Six full-sized 16-bit and two full-sized 8-bit slots
- Five 5.25" half-height drive bays
- CompuAdd Windows 3.0; MS-DOS 4.01

\$2349 (66915)

CompuAdd CompanionSX

- 80386SX rated at 20MHz
- 2MB DRAM expandable to 6MB
- 20MB (23ms) hard drive
- 3.5" 1.44MB diskette drive
- 10" diagonal mono VGA display
- 79-key keyboard/101 key emulation
- CompuAdd MS-DOS 4.01
- 5.7 lbs; 11" x 8.5" x 1.8"

\$2995 (62301)

CompuAdd 316s

- 80386SX rated at 16MHz
- 2MB DRAM expandable to 4MB
- Monochrome monitor
- 40MB hard drive
- Three full-sized 16-bit and two half-sized 8 bit slots
- One 5.25" and two 3.5" half-height drive bays
- CompuAdd Windows 3.0

\$1675 (66900)

CompuAdd 333T

- 80386 rated at 33MHz
- 4MB DRAM expandable to 16MB
- 80MB hard drive
- Monochrome monitor
- Cache controller with 64KB SRAM
- Six 16-bit and one 8-bit full-sized slots
- Four half-height front access and five half-height internal 5.25" drive bays
- CompuAdd Windows 3.0; MS-DOS 4.01

\$3375 (66658)

CompuAdd®

Customer driven, by design.

Call 800-388-1296

Computers for people who value their time.



Call for our hardware and software catalogs.



Visit one of the 90 CompuAdd SuperStores.



Or call our corporate sales team.

You've worked hard to get your priorities straight. Even though you depend on computers to get your work done, you don't want to waste time worrying about buying them. With CompuAdd, buying computers is easy — and risk-free! We give you more sales and service options than any other computer company. You can get started with a single toll-free telephone call or a visit to one of our 90 CompuAdd SuperStores.

CompuAdd is a complete sales and service resource. We're the only major PC company that owns its entire delivery system from engineering through manufacturing and direct sales.

Catalog Sales:
800-627-1967

Corporate Sales:
800-456-3116

Advanced Systems Group:
800-688-6380

Federal Government Sales:
800-688-6803

International Sales:
512-258-5575

Whether you buy a CompuAdd system (or an entire network of computers) from our catalog, from one of our retail stores or from our national or international account teams, you get all the benefits of our entire distribution system. You can even buy computers over the phone and then have them serviced at your local store. And you always get toll-free technical support from the same company that engineered your system. Whatever your needs, you deal directly with the manufacturer.

Call CompuAdd. We make computers for people who value their time.





It's about time.

CompuAdd®

Customer driven, by design.

Call 800-388-1296 Key Code 832

Hours: Monday - Friday 7:00am to 9:00pm CST; Saturday 9:00am to 5:00pm CST
12303 Technology Blvd. Austin, Texas 78727

 800-387-3266  95-800-010-0401  0800-373535  0130-6009  1-40364949



Why IBM and Apple Should Be Friends

A marriage of the two PC giants would be more natural than you'd think.

PC journalists had a field day recently over news that IBM and Apple were holding peace talks. Predictably, officials from both companies said little about the subject, but just one whiff of those discussions was enough to set keyboards clattering everywhere—including here at *PC World*.

As crazy as it sounds, Apple and IBM are discovering plenty of reasons to cooperate. Both PC titans are in the throes of major crises. IBM is losing ground to less expensive, high-power clones. Apple is gaining users but losing profits with its new, low-price product line. Both companies are feeling the heat from workstation heavyweight Sun Microsystems. And both are plenty worried about mutual archrival Microsoft and its smash hit, *Windows*.

But shared worries alone don't make a relationship. Apple and IBM actually have a great deal of PC innovation to offer one another, and their combined technologies could set the pace in emerging areas such as pen-based PCs, multimedia, and graphical workstations. Most of all, an alliance between Apple and IBM could add a new element of choice to the PC arena, furnishing perhaps the only credible alternative to the Bill Gates *Windows* strategy now on the horizon.

New Software for New PCs

To get out of their rut, Apple and IBM need to sell more PCs—lots of them. But industry standards—DOS, and now *Windows*—have made it virtually impossible for either vendor to lock up the majority of PC purchases. So together IBM and Apple are heading toward areas where *Windows* hasn't yet taken root. In pen-based PCs, for example, the behemoths appear to be lining up behind Go Corporation's PenPoint operating system, versus Microsoft's *Pen Windows* or a special pen version of the Mac system software. Since PenPoint features a more advanced, easier-to-use interface than either *Windows* or the Mac, it may prove a meeting ground for software that unites the companies' desktop PCs, too.

In multimedia, both Apple and IBM are feeling enormous pressure from a Microsoft-led coalition of hardware vendors who have agreed to build *Windows*-compatible multimedia PCs and peripherals. Many believe that PCs capable of juggling sound, animation, and video stand a good chance of ushering in a new era in home computing—just the ticket to revive IBM's and Apple's profits. Moreover, multimedia can merge with networking to spawn new kinds of business applications—integrated voice mail and E-mail, for example. Tandy, AT&T, NEC, Philips, and Zenith have already thrown their weight behind multimedia *Windows*, so Apple and IBM may find cooperation neces-

sary for sheer survival.

The hardware giants face an even more severe challenge on the workstation front. Low-price workstations like Sun's represent the future of office desktop PCs—graphical, fully networkable, capable of integrating information from throughout an organization. So far, Microsoft has succeeded in uniting a consortium of far-flung competitors like Compaq and DEC behind a standard based on a future version of *Windows* that supports high-speed RISC chip technology. With OS/2 and its own RISC chips to promote, IBM desperately needs a hardware partner. With a version of the Mac operating system for RISC systems, Apple may find a willing collaborator in IBM.

Elsewhere, Apple and IBM may be able to exploit Microsoft's weaknesses to their advantage. It's no secret, for example, that *LAN Manager* has been a failure compared to Novell's NetWare or even Apple's own *AppleTalk*. IBM has tied the knot with Novell but could still use some help to network PCs in small organizations that don't need the power or the hassle of NetWare. With a broad, integrated product line, IBM, Apple, and Novell would form an invincible networking bloc.

The Payoff: A Bigger Marketplace

In contrast with the wild-and-woolly days of the first PC clones, this new era of cooperation between industry giants (*continues*)

Take the Express route to Windows Standardization.

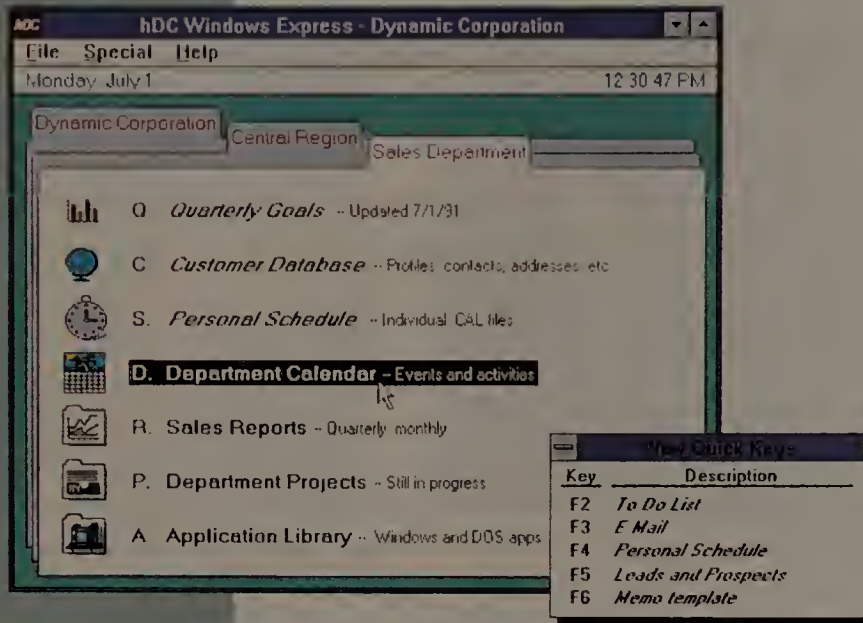

Moving
To
Microsoft
Windows

Switching from DOS to Windows can be a very smart move. But, as you may have discovered, it's not as easy as putting a package on everyone's desk. ■ That's why we developed hDC Windows Express™, the corporate menu system that puts you back in control of the company workstation. ■ And that's why we're making *Moving to Microsoft® Windows™* available to you for just \$7.95.* This handy guide leads you through the process of standardizing on Windows. ■ For your copy, and a free disk of hDC utilities, call 800.321.4606 today.

*Plus shipping and handling. hDC products are distributed worldwide, call 206.885.5550 for the distributor in your country.

hDC Windows Express, the fast painless way to move Windows. It provides:

- ✓ **Standard Windows Menus**
 - Create a company-wide interface
 - Create menus for specific work group needs
 - Integrate DOS and Windows applications seamlessly
 - Implement menus easily over multiple workstations
 - Support multiple users on a single workstation
- ✓ **Comprehensive Network Support**
 - Works with all Windows 3.0 compatible networks
 - Environment variable support allows standard menu to be tailored by department or user
- ✓ **Simplified Network Administration**
 - Create custom network menus easily
 - Edit network menu file—while users are accessing files
 - Reduce training and support costs
 - Site license programs available
- ✓ **Enhanced System Security/Control**
 - Separate Editor program for menu design
 - Password protection
 - Option to disable access to file operations such as move and delete

Suggested U.S. retail price \$99.95



hDC Computer Corporation
6742 185th Avenue NE
Redmond, Washington 98052

Quote reprinted from PC Magazine, February 1991. © 1991 Ziff Communications Company
© Copyright 1991, hDC Computer Corporation, hDC Windows Express are trademarks of hDC Computer Corporation. Microsoft is a registered trademark and Windows is a trademark of Microsoft Corporation.

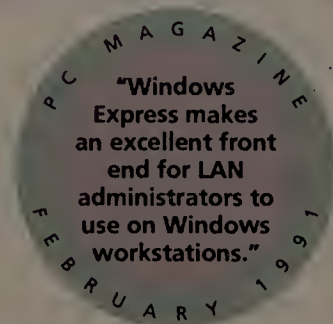

might strike some as a step backward. Why encourage technology leaders to square off against each other in groups of twos and threes when it seems better all around for them to agree on hardware and software standards?

The answer's pretty clear. At more than 60 million units installed and growing, the PC world is big enough to handle some diversity. Multimedia and pen computing represent new opportunities for simpler, more powerful PCs. Workstation technology can breed a class of high-performance desktops capable of handling tasks we can only imagine. Nobody wants to stifle such developments with outdated or inappropriate standards. But with such boundless possibilities, it will take powerful software glue to hold all the pieces together—and a few determined companies that can make their promises stick.

As always, I'm interested in your opinions on this or any other subject. Write to me at *PC World*, 501 Second St. #600, San Francisco, CA 94107; fax 415/442-1891; MCI Mail Richard Landry/301-3685. ☉

POWER TIP NO. 200

Losing Your Changes With 1-2-3 2.2

If you try to quit 1-2-3 2.2 with unsaved changes in your worksheet, the program alerts you—but don't let this seeming safety net lull you into a false sense of security. You can still load a new file over your current worksheet and lose all your changes without a peep from 1-2-3. So use good work habits and save frequently. Then even if you have an accident, it probably won't be a disaster.

Rex Farrance
Assistant Editor

The Windows Revolution Comes To Accounting.

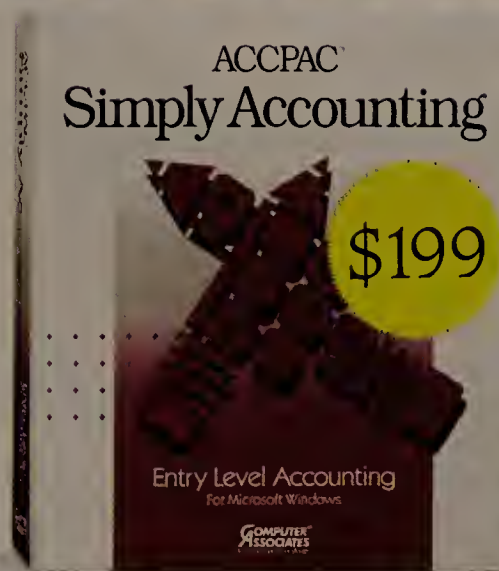

Introducing New ACCPAC Simply Accounting For Windows. It's Easy To Learn, Easy To Use And Only \$199.

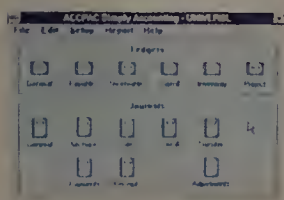

Now accounting is quick, easy and trouble-free thanks to ACCPAC® Simply Accounting™ For Windows.™

You'll have it up and running in minutes. And with the Windows interface, you can do anything with just a few clicks of the mouse. Write a check. Print out an invoice. Do your payroll. Manage your receivables.

What used to take hours now takes just min-



CA's Computing Architecture For The 90s Protects Your Investment.



utes. So you can spend less time counting your money—and more time making it.

And since it costs only \$199, you can take care of your books without breaking the bank.

Call us today at 1-800-645-3003 in the U.S. or 1-800-663-6904 in Canada for the location of your nearest dealer.

Haven't you waited long enough?



For Only \$199, You'll Get: • General Ledger • Accounts Payable • Accounts Receivable • Payroll • Inventory Control • Job Costing • Prints Checks, Statements, Invoices and Mailing Labels • Produces Standard Accounting Reports • Quick Set-Up

©1991 Computer Associates International, Inc., 711 Stewart Avenue, Garden City, NY 11530-4787. All trade names referenced are the trademarks or registered trademarks of their respective companies.

Circle 58 on reader service card

dFacts Are In.

DATABASE COMPARISON TABLE	dBASE IV version 1.1	Paradox version 3.5	FoxPro version 1.02
EASE OF USE			
Control Center organizes data, queries, forms, reports, labels, applications on <u>one</u> screen	Yes	No	No
Create applications <i>without programming</i>	Yes	Yes	No
Modem pulldown menus for all Design Tools	Yes	No	Limited
Query by Example (QBE) for easy access to information	Yes	Yes	No
Context specific help by menu item	Yes	No	No
PRODUCTIVITY			
Quick Layout for automatic forms, reports and <u>labels</u>	Yes	No	Yes
Application Generator for quick application development	Yes	Yes	No
Automatic code generation for all Design Tools	Yes	No	No
Automatic maintenance of <u>multiple</u> indexes for ordering data	Yes	No	No
Memo fields for notes, letters, descriptions	Yes	No	Yes
POWER & FLEXIBILITY			
Bold, underline, italic, subscript, superscript text for high impact reports and labels	Yes	No	No
User Defined Functions for extending programming language	Yes	No	Yes
Data input validity checking in forms	Yes	Yes	Yes
Multi-user transaction processing ensures data integrity	Yes	No	No
Number of file formats imported/exported	7	6	3
INDUSTRY STANDARDS			
#1 Selling, #1 Rated multiuser database; over 3 million users (1)(2)	Yes	No	No
Compatible with dBASE III PLUS data and applications	Yes	No	Yes
Compatible versions for DOS, VAX VMS, Macintosh, SunOS and other UNIX platforms (3)	Yes	No	Limited
Structured Query Language (SQL) integrated with programming language	Yes	No	No

(1) dBASE III PLUS and dBASE IV comprise approximately 55% of PC database systems sold (3 times nearest competitor) according to the most recent report by the market research firm Audits & Surveys (Oct. 1990) (2) Software Digest rated dBASE IV #1 among multiuser databases, October 1990 (3) Versions of dBASE IV are shipping for DOS, VAX, and SunOS. Macintosh and other UNIX Platforms are announced.

Based on what our customers tell us, we made a list of some of the most important features to look for in data management software.

Then we compared the new dBASE IV® version 1.1 with two other database products.

As you can see, dBASE IV offers exclusive advantages in

many categories.

For instance, only dBASE IV lets you access all its functions from a single screen. Called the Control Center, this screen lets you manage existing data, and create new tables, queries, reports, forms and labels totally without programming.

When all the facts are on the table, it's easy to see which database software is best.

Of course we aren't the only ones who have come to this particular conclusion.

Software Digest rates dBASE IV version 1.1 the #1 Multiuser Database (Vol. 7, No. 13, Oct. '90).

The Truth Comes Out.

Perhaps the most independent publication in the industry, *Software Digest* accepts no advertising whatsoever. Corporations pay hundreds of dollars a year to receive their monthly reviews—which are considered highly unbiased and objective. Their exhaustive, 75-page report concludes:

“Among the top ranking programs, dBASE IV (version 1.1) is the most well-rounded, with solid performance, versatility, and usability.” Commenting on speed, *Software Digest* points out that “dBASE IV produces all three test reports as fast as or faster than FoxPro/LAN.” As for Ease of Use and Ease of Learning, dBASE IV scored in the Excellent Range as many times as any other multiuser database product tested.

For a free evaluation kit, including competitive details and a free demo disk, call toll-free:

1-800-437-4329 ext. 1416.

Better yet, call 1-800-2ASHTON to upgrade to the new dBASE IV now.

The truth is, no other database can do so much to improve productivity.



 Ashton-Tate®

Software Digest RATINGS REPORT
 Volume 7, Number 13
 The Independent Comparative Ratings Report for Selecting IBM PC Business Software

MULTIUSER DATABASE PROGRAMS

Ratings Key: ■ 7.0-10.0 ■ 5.0-6.9 ■ under 5.0

Software Digest Rating	Overall Evaluation	Overall Power	Program Name	Version Tested	Performance	Versatility	Error Handling	Ease of Learning	Ease of Use	Memory Requirement	Price	Volume Purchase Agreements	Page
★★★	7.0	6.7	dBase IV	1.1	■	■	■	■	■	450KB	\$795	✓	28
★★	6.8	5.1	Paradox	3.5	■	■	■	■	■	640KB	\$995	✓	32
★★	6.8	7.1	FoxPro/LAN	1.02	■	■	■	■	■	512KB	\$1,095	✓	30
★★	6.4	5.1	DataEase	4.2	■	■	■	■	■	640KB	\$750	✓	26
★	5.8	3.6	R:Base	3.0	■	■	■	■	■	520KB	\$995	✓	34
★	5.7	6.0	Clarion Professional Developer	2.1	■	■	■	■	■	512KB	\$845	✓	24
★	5.7	6.6	Advanced Revelation	2.01	■	■	■	■	■	640KB	\$995	✓	22

REPRODUCTION OR QUOTATION IN WHOLE OR IN PART IS PROHIBITED WITHOUT PRIOR WRITTEN PERMISSION
 All rights reserved © 1990 by NSTL, Inc. Plymouth Corporate Center, Plymouth Meeting, PA 19462, 800-223-7093

Rock Solid OCR

OmniPage Professional





Eight out of ten businesses chose *OmniPage*[®] for their OmniFont OCR. So we developed *OmniPage Professional*, to meet the needs of the other two.

As with *OmniPage*, you can still scan virtually any document, no matter what font, font size or column format – and accurately enter it into any PC compatible or Macintosh[®] file. All at impressive speeds of up to 2000 wpm (words per minute) in powerful 486 systems. You still have all the power of *OmniPage*'s AnyFont™ technology, which is the world's most accurate OCR software.

According to *InfoWorld*: "Accuracy is the most important feature of an OCR package. . . *OmniPage* was the most accurate program we tested."

And now with *OmniPage Professional* you have something not found in any other OCR software – including *OmniPage* – complete *customizability*.

The new Custom Characters feature, for example, lets you learn special characters unique to your business or profession; including logo type, stylized fonts, scientific or mathematical symbols – even difficult to read shapes like α , $\text{\textcircled{B}}$, , , @ and \leftrightarrow , as well as broken or smudged characters.

OmniPage Professional includes the world's only dedicated OCR spellchecker which lets you go beyond 100% page recognition, correcting errors even in the source text.

Add to all of this Deferred Processing, or the ability to scan now and recognize

later, and *OmniPage Professional* delivers not only the world's fastest and most accurate OCR solution, but the most *customizable* as well.

Visit an authorized Caere dealer today and see for yourself how *OmniPage Professional* can help you to eliminate unnecessary keystrokes – forever. *OmniPage Professional*, only from Caere, the Complete Recognition Company.



Caere Corporation
100 Cooper Court
Los Gatos, CA 95030
1-800-535-SCAN

CAERE[®]

All ®registermarks and ™trademarks are of their respective companies. ©1990 Caere Corporation.

Circle 17 on reader service card



LETTERS

Reactions and responses from the PC World community

Hats off to IDG—PC World's parent company—for its commendable effort to place old PCs in Eastern Europe. We should also promote similar programs closer to home, but we can't ignore the benefit in opening up this part of the world to PCs.

*David J. Grein
Rochester Hills, Michigan*

Charity begins at home. Local schools, United Way organizations, branches of national health organizations, and any number of other deserving institutions would be thrilled to receive those cast-off computers. There's nothing wrong with helping Eastern Europeans. Let's be sure we're not overlooking the needy who are right under our noses.

*Rick Fischer
Memphis, Tennessee*

The flood of letters we received on this issue reflects your commitment to helping those in need, here and abroad. Although we couldn't find a nationwide domestic institution to match IDG's East-West Education Development Foundation, excellent programs operate at the state and local level. For example, Computers and You, a non-profit organization founded in 1988 by PC World Communications' then-corporate chairman David Bunnell and IDG, is based in San Francisco and offers computer training and education to homeless children and their parents. PC World, with the blessing of the Software Publishers Association, donates demonstration software to CompuMentor, a Northern California group that distributes software to non-profit groups. Educators tell us they welcome any help they can get. So if you want to help your community and

don't have a program in mind, your favorite school or community college is a great destination for computers and other PC equipment you no longer use.
—Richard Landry

Are Dell Ads Unfair?

I'm fed up with the Dell Computer ads I see every month in your magazine. Dell says you can have their computers for much lower prices than Compaq's and get better service too. But when you compare Compaq's actual street prices with Dell's, the differences are less than the ads indicate. Anyone who's been in the computer business as long as I have knows that Compaq stands behind its machines. If a user is ever unhappy with service, nine times out of ten it's the fault of the dealer. Compaq machines are technically superior. They outperform and outlast most brands, and the price difference is worth it.

*Ray Parton
Seattle, Washington*

Two-Fisted Fan

I'm a fan of Mark Marek's *Two-Fisted Management*. Arnold Harris's antics give adults in the corporate world an opportunity to laugh about all-too-familiar situations. In addition, the cartoon serves as an aid in developing the proper attitude for survival in hostile business environments. So don't even think about messing around with the strip, or I'll have your jobs!

*Loras J. Holmberg
Plymouth, Minnesota*

Boarding the EISA Bus

After reading your April review "33-MHz 386s: Survival of the Fastest," I wonder why you don't give more atten-
(continues)



MARY LYNN BLATSUTTA

Charity Begins at Home

Richard Landry's May column ["Multimedia: What's It Good For?"], with its suggestion to send our obsolete computers to Eastern European students, compels me to ask a question: Why do we need to look outside our own country for a good cause? I don't want to sound like an isolationist—I applaud the idea of helping Eastern Europeans. Still, there are plenty of students right here who'd benefit from having a PC or two in school. Perhaps then they'd be able to learn enough for us to stay educationally equal with the rest of the world.

*Albert M. Halowell
Pittsburgh, Pennsylvania*

ANTHONY RUSSO

tion to the Extended Industry Standard Architecture bus. Is it because all the system and applications software so far available doesn't take advantage of its 32-bit potential? Or is it because you aren't yet seeing any EISA boards that outperform 16-bit AT boards?

Everett Wallace
Los Angeles, California

Current operating systems, programs, and EISA boards can take full advantage of the EISA bus's ability to drive 32-bit peripherals. But only a demanding application, such as a high-performance server or graphics workstation, generates enough input/output demand to overtax a conventional 16-bit bus. Even though few single

users can benefit from EISA today, as I/O demands increase and production costs come down, you'll find more EISA systems on the desktop. —Ed.

Unabashed Mac-Bashing

I'm tired of reading PC-bashing letters, like the one from Carleton Sarver in May, that draw unfavorable comparisons between PCs with *Windows* and the Mac. The Mac's operating system is awkward and silly, and as far as icons go, who cares? Glitter is nice, but performance is essential. And if you buy an affordable Mac, you're stuck with a black-and-white TV in a shoe box.

Brett Williams
Austin, Texas

MoneyCounts to This Reader

I was amazed by your low rating of the easy-to-use *MoneyCounts 6.5* in April ["More Profits From Personal Finance"]. With just the basic *MoneyCounts* program, I was able to reconfigure my church's accounting system, which included about 175 accounts and subaccounts. Frankly, I appreciate that I don't have to pay for extras like the *CheckFree* payment service unless I want them. But if I add in every option Parsons Technology offers, I still wind up with a nicely integrated package that's less expensive than *Managing Your Money 7.0*.

Matt Gatchell
Cedarburg, Wisconsin

Taking the Bull by the Horns

Your review of *Corel Draw 2.0* in May's Windows Special Report peddles some pure bull! Terrific as Best Buy *Corel Draw* is, it doesn't convert its fonts to Adobe Type 1 format. A bug in the WFNBOSS conversion utility prevents a clean conversion, as your *Bug Watch* in the same issue indicates. This kind of error makes me wonder why *PC World* isn't verifying all the functions of the products it reviews.

Jim Long
Ellington, Connecticut
(continues)

**TRY THE TELESCAN SYSTEM.
IT'S JUST \$44 FOR 30 DAYS.**

Fast...Powerful...It's the most advanced investment software on the market today.

Try ProSearch, our unique stock search program, and Analyzer, our powerful analytical software, plus a comprehensive, interactive data base.

- Access 7,000 stocks, 35,000 options, 1,800 mutual funds, 197 industry groups, and 560 indexes...in seconds.
- Customize searches on the NYSE, AMEX, NASDAQ...in 15 seconds.
- Retrieve 18 years of data...instantly.
- Plot technical indicators for buy/sell signals.
- Read late-breaking news stories and access the #1 rated investment newsletter.
- And much, much more!

**CALL TODAY
FOR THIS \$44 TRIAL OFFER
1-800-324-8353**



10550 Richmond
Suite 250
Houston, Texas 77042



Requires an IBM or compatible PC and Hayes or compatible modem.

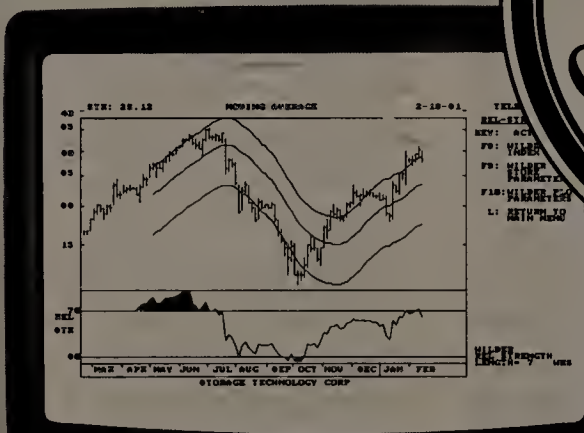

Circle 274 on reader service card



T H E
S O L I D
SOLUTION

CTX is the rock solid solution to your color monitor needs.

You just can't beat the uncompromising quality, performance and reliability, plus the very affordable prices.

CTX has been in the worldwide market since 1982, providing computer users with solid, state-of-the-art technology along with solid nationwide service.

Available from CTX is a full range of powerful 14" color monitors: from the top-of-the-line Multiscan to a Super VGA and Deluxe and Standard VGAs as well as EGAs and CGAs.

	<i>Multiscan</i>	<i>Super VGA</i>	<i>Deluxe VGA</i>	<i>Standard VGA</i>
Model	3436	5468	5432	5439
Resolution	1024x768	1024x768	640x480	640x480
Horiz. Freq.	15.75-38 KHz	30-38 KHz	31.5 KHz	31.5 KHz
CRT Dot Pitch	.28 mm	.28 mm	.29 mm	.39 mm

Add to all these features complete IBM and Macintosh compatibility, handy up-front controls, non-glare direct etch screens, detachable tilt/swivel bases, and reliable nationwide servicing, and you will agree that the CTX monitors are the best deal available on the market.

—Technological Excellence.

—Unbeatable Performance.

—Exceptional Pricing.

For the solid solution to choosing color monitors, see your local CTX dealer or contact:

CTX INTERNATIONAL, INC.

161 Commerce Way
Walnut, CA 91789
714/595-6146, FAX 714/595-6293

CTX SOUTH, INC.

6090-F Northbelt Parkway
Norcross, GA 30071
404/729-8909, Fax 404/729-8805

Factory:

CHUNTEX ELECTRONIC CO., LTD.

6F, No. 2, Alley 6, Lane 235, Pao Chiao Rd.
Hsin Tien, 23115 Taipei Hsien, Taiwan, R.O.C.
886-2-9175055, Fax 886-2-9172736

Watch for CTX's new 17" and 21" Large Screen Displays coming soon.



WHERE MONITORS ARE CTXELLENT

Circle 53 on reader service card

Why
our Tempo
can't be
beat.

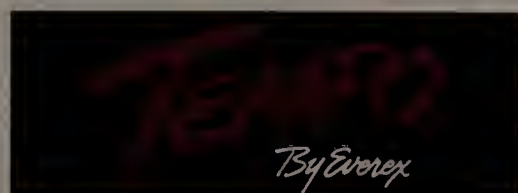



Tempo 486SX/20

\$2,599

- Intel® 80486SX 20MHz CPU
- VGA Adaptor Included
- Standard 1MB RAM (Expandable to 32MB)
- 128KB Static RAM Cache
- 1.2MB 5.25" Diskette Drive
- Zero Wait-State Operation
- Intel 80387 Math Coprocessor Socket
- Small or Large Footprint
- DOS 5.0 Included
- Novell® Certified



Tempo 386/25

\$1,699

- Intel 80386 25MHz CPU
- Standard 1MB RAM (Expandable to 16MB)
- 64KB Static RAM Cache
- 1.2MB 5.25" Diskette Drive
- Zero Wait-State Operation
- Socket for Intel 80387 or Weitek® 3167 Math Coprocessor
- DOS 5.0 Included
- Novell Certified



Tempo 386/20

\$1,549

- Intel 80386 20MHz CPU
- Standard 1MB RAM (Expandable to 16MB)
- 64KB Static RAM Cache
- 1.2MB 5.25" Diskette Drive
- Zero Wait-State Operation
- Socket for Intel 80387 or Weitek 3167 Math Coprocessor
- DOS 5.0 Included
- Novell Certified



Tempo 386SX/16

\$1,149

- Intel 80386SX 16MHz CPU
- Standard 1MB RAM (Expandable to 8MB)
- 1.2MB 5.25" Diskette Drive
- Zero Wait-State Operation
- Small or Large Footprint
- 80387SX Math Coprocessor Socket
- DOS 5.0 Included
- Novell Certified



Tempo LX Notebook ALL NEW! \$2,899†

- Intel 80386SX 20MHz CPU
- VGA Backlit Display
- 2-3 Hour Battery Life
- Power Conservation Mode
- 1-Hour Quick Charge
- Full-Travel, 83-Key Keyboard
- 1MB RAM (Expandable to 5MB)
- 20MB, 40MB or 60MB Internal Hard Drive
- 1.44MB 3.5" Internal Diskette Drive
- 80387SX Math Coprocessor Socket
- DOS 5.0 Included
- 7.1 lbs (Including Battery)



Tempo 286/16

\$999

- 80286 16MHz CPU
- Standard 1MB RAM (Expandable to 4MB)
- 1.2MB 5.25" Diskette Drive
- Zero Wait-State Operation
- Small or Large Footprint
- 80287 Math Coprocessor Socket
- DOS 5.0 Included
- Novell Certified



Tempo 286/12

\$949

- 80286 12MHz CPU
- Standard 1MB RAM (Expandable to 4MB)
- 1.2MB 5.25" Diskette Drive
- Zero Wait-State Operation
- Small or Large Footprint
- 80287 Math Coprocessor Socket
- DOS 5.0 Included

Price has a lot to do with it. But don't let the prices fool you.

With the Everex™ Tempo™, we have created ideal tools for businesses that require low cost IBM®-compatible PCs with performance that never lets up. In an office or on the road, they're everything you or your company will need for optimum PC performance.

Each product in the Tempo family includes an enhanced keyboard. One parallel and two serial ports*. Eight expansion slots for the large and small footprint models, four for the slimline compact footprint, and one proprietary for the Tempo LX Notebook. 1:1 interleave hard disk controllers. And, they're supported by a full array of Everex peripherals.

What's more, every Tempo PC is

compatible with the high-performance Everex STEP™ line of computers.

Every Tempo computer is backed by a full one-year parts warranty and a three-month on-site service warranty.

Catch the Tempo family at a reseller near you. To find out where, call 1-800-345-3839. Outside the U.S., call 415-498-1111 or FAX us at 415-651-0728.

But hurry, because at these prices, the Tempo is moving fast!



In Canada, call 1-800-663-5161. †16MHz version. *Tempo LX has one serial and one parallel port. Suggested retail prices, subject to change without notice. Prices do not include monitor or mouse. © 1991 Everex Systems, Inc. EVER for EXcellence is a registered trademark and Everex, Tempo and STEP are trademarks of Everex Systems, Inc. Other company and product names are trademarks and registered trademarks of their respective companies.

When we tested Corel Draw 2.0, we didn't encounter the problem Mr. Long mentions. According to Corel Systems, this malfunction doesn't occur with all conversions—but the company assures us that they expect to ship a fix before you read this. We apologize for letting this bug get through our net, and we've taken steps to ensure that

from now on the information in our new Bug Watch is given to all review editors before press time. —Ed.

Communications Dispute

We appreciate the Best Buy you gave our communications package *Procomm Plus 2.0* in April ["Easier Tools for the On-Line World"]. But I was disturbed at

your charge of faulty DEC terminal emulations; we've always considered them among *Procomm Plus's* strongest features. Author Judy Heim's vague criticisms of backspace and function key behavior are particularly surprising, considering that users can remap the keys to fit their needs. I have no record of *PC World* calling our technical support to discuss these problems, and I suspect they relate to user settings rather than any bug in the program.

*Phil James
Datastorm Technologies
Columbia, Missouri*

I tested the DEC emulations on each program using the default settings. I called a VAX and ran a variety of editors and data base software. Procomm Plus 2.0 was the only package that displayed backspace and function key problems. With backspace in destructive mode, for example, characters I erased disappeared from the screen but remained in the edited file. And none of the function keys worked properly in VT220 emulation: While connected to a VAX running Ingres' ISQL terminal monitor, I couldn't even execute a command. I apologize for my oversight in not discussing these problems with Datastorm's technical support. But users shouldn't have to re-map keys to achieve adequate terminal emulations. —Judy Heim

BUILD TO SUIT.

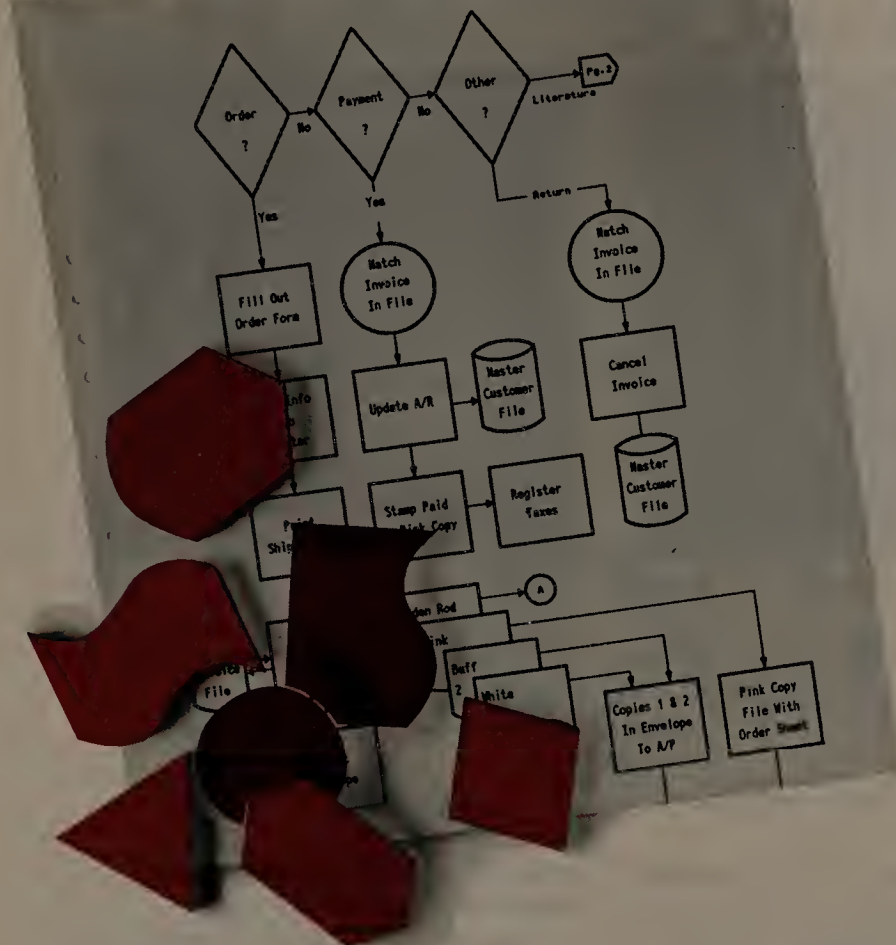

Now, you can create, update and print presentation-perfect flowcharts to your specifications — in no time!

Quick to master and a snap to use, Patton & Patton's flowcharting software is the standard of both large and small businesses around the world — and is available through all major software dealers.

See your dealer today! Or, for a "live," interactive demo disk, call: **800-525-0082**, ext. 2508
International: 408-778-6557, ext. 2508

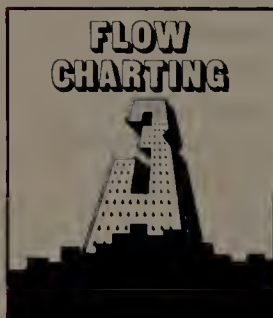

PATTON & PATTON
Software Corporation

Excellence in charting the flow of ideas!

Works on IBM & 100% compatible PC's, supports CGA/EGA/VGA and over 150 dot matrix and laser printers, with multiple print densities and 10 font sizes. **Creates multi-page charts, portrait or landscape, on most standard paper sizes.** Mouse or keyboard controlled. Supports International Characters.

IBM is a registered trademark of International Business Machines Corporation.

Circle 233 on reader service card

More Strategic Data Resources

Your April Buyers' Guide "Strategic Data Sources" presented an informative array of on-line and CD ROM data bases. For your readers' information, I'd like to add two widely used resources to your list. National Decision Systems pioneered the delivery of geographic-specific census, current year update, and five-year projection data via our *Infomark* desktop CD ROM and PC system. Our *Business-Facts* data base (also delivered via *Infomark*) provides the nation's most complete coverage of U.S. business marketing information, (continues)

With Word for Windows, what you see is what you get.



PC Magazine, December 11, 1990



PC World, May 1990

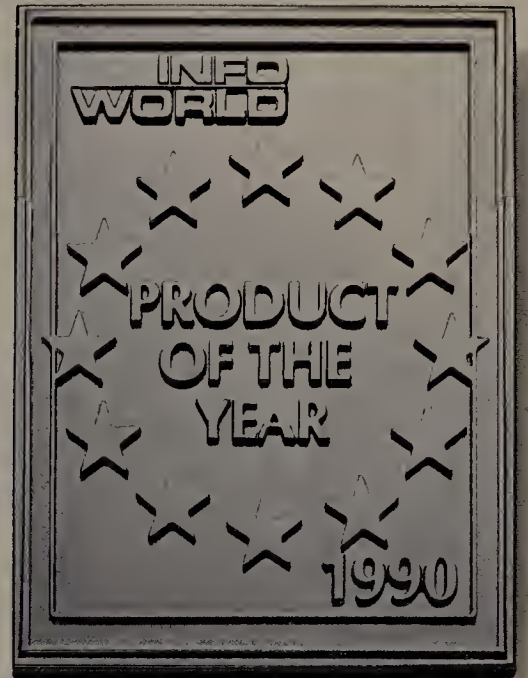

InfoWorld: Product of the Year, February 4, 1991



Byte, January 1991



InfoWorld: Buyers Assurance, January 7, 1991

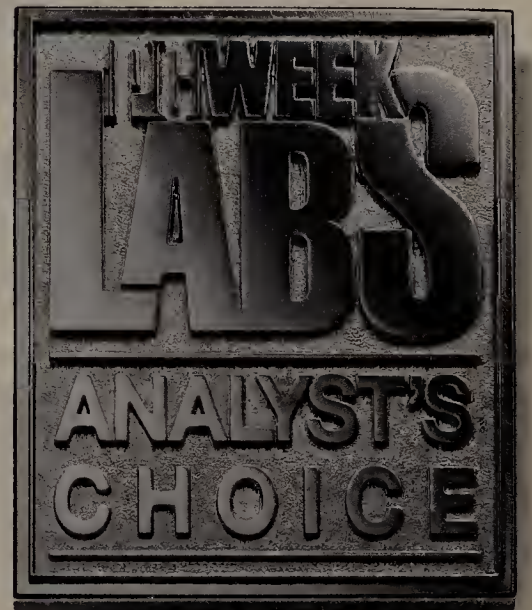

PC Week, December 24, 1990



WYSIWYG. Generally it means what you see on-screen is what you get from the printer. But, with Microsoft® Word for Windows™ it also means you're getting the best Windows word processor avail-

able. Just one look above proves it. Why not call (800) 426-9400, for the name of the dealer nearest you. And see exactly what you could be getting.

Microsoft
Making it all make sense™

Hassle-Free Printer Sharing

for the HP LaserJet II, IID, III and IIID



"The ServerJet is the smoothest and most practical way I know to share a LaserJet."

Frank J. Derfler, Editor
PC Magazine, 1/15/91

Here's how you and your co-workers can have your own HP LaserJets without breaking the corporate budget.

It's called **SimpLAN ServerJet**.

Simply plug the *ServerJet* into the 'Optional I/O' slot of your HP LaserJet. Stretch phone cable, up to hundreds of feet, to each computer. Then, 12 people can simultaneously *whooshhh* documents to the LaserJet at speeds as fast as 115,200 baud.

No more wandering down the hall with floppy in hand.

Or borrowing someone else's LaserJet.

Or wasting time waiting to print.

SimpLAN & ServerJet are trademarks of ASP Computer Products, Inc. / HP LaserJet is a registered trademark of Hewlett-Packard Co.

The *ServerJet* is available in a variety of models with up to 4MB of buffer memory. And because your office may have printers other than HP LaserJets, ASP Computer Products offers a complete line of printer sharing solutions.

To order your *ServerJet* or for more information call ASP at:

800-445-6190



ASP COMPUTER PRODUCTS, INC.

1026 W. Maude Avenue, Suite 305
Sunnyvale, California 94086
Phone: 408-746-2965 • Fax: 408-746-2803

Circle 43 on reader service card

LETTERS

with over 10.2 million businesses. And in addition, we make both of these services available via a toll-free number (800/866-6510).

Randy Grimm
National Decision Systems
Encinitas, California

Send reactions, responses, and ideas to Letters, PC World, 501 Second St. #600, San Francisco, CA 94107; CompuServe 74055,412; MCI Mail PC World Editorial; or 415/442-1891 (fax). Include your name, city and state, and phone number. We reserve the right to edit letters. ☺

POWER TIP NO. 193

Avoiding Conflicts With Tiffany

If you need to take a Windows screen shot with *Tiffany*, but *Tiffany* conflicts with the application you're running, use Windows' built-in screen dump feature. Press <Print Screen> to capture the entire screen to the Windows Clipboard or <Alt>-<Print Screen> to capture the active window. Open the Clipboard, and save the image to disk as a CLP file. As there's no utility that reads CLP files, load *Tiffany* (set to save images in color PCX format), load the Clipboard, and maximize it to full screen. Then load the CLP file, and press <F11> to save the image as a PCX file. Unfortunately, you'll also get the Clipboard's menu bar. To do away with it, load the PCX file into Windows' *Paintbrush* and just wipe out the menu bar. Voilà—you have a screen shot.

Robert Luhn
Senior Editor

PC Tools™ & DOS 5.

They're so good together, it makes you wonder if it's just a working relationship.

No PC should be without DOS 5.0. And no DOS 5.0 user should be without new PC Tools™ 7.0.

Only PC Tools 7.0 builds upon the data recovery actually in DOS 5.0. We know. We wrote it.

It's so good Brad Silverberg, Microsoft's VP in charge of DOS 5.0 said, "We chose PC Tools because it's the best technology on the market."

And now PC Tools 7.0 gives you even more. Like data recovery on networks. Automatic utilization of DOS 5.0's high memory to give your applications more room. Detection of over 600 known viruses. And remote computing that actually lets you operate your office PC from your home PC or laptop, via modem.

Only the DOS shell in PC Tools gives you access to undelete, locate, and over 35 file viewers. And since it uses a look and feel licensed from Microsoft, you'll spend your time using our utilities instead of learning them.

PC Tools 7.0 even includes real Windows applications for Backup and Undelete that are data and keystroke compatible with their DOS 5.0 counterparts.

So call 1-800-445-4346 today for the name of a PC Tools dealer nearest you. And upgrade your upgrade.

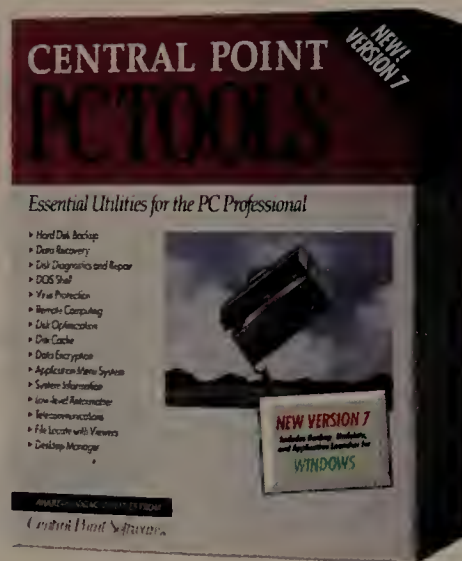

Central Point Software INC[®]
Making Computing Safer, Simpler, Faster.

“We Chose PC Tools Because It Is The Best Technology On The Market.”

Brad Silverberg, VP for DOS & Windows, Microsoft

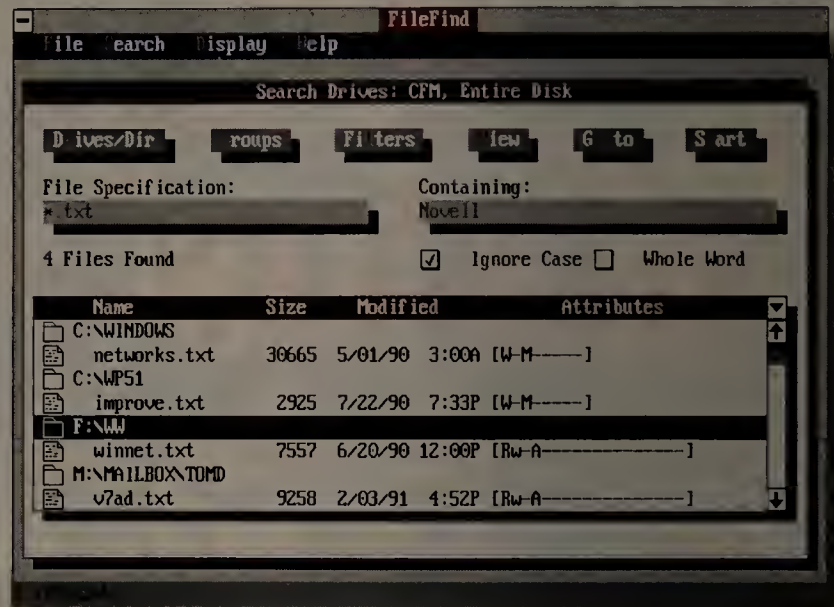
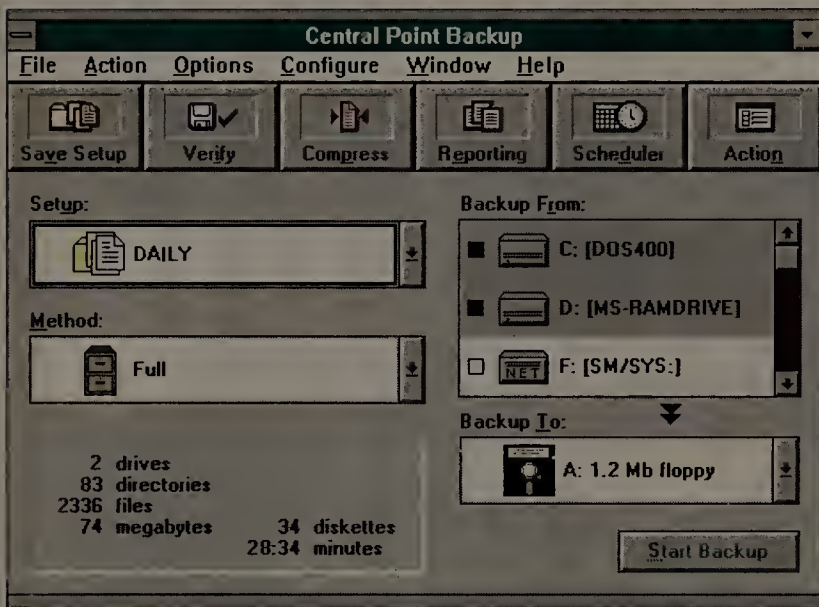

DOS and Windows Backup. Only PC Tools gives you award-winning backup for DOS and Windows in one box. Both programs use the same keystrokes and file formats so you can move to Windows without a hitch.

File Find with Viewers. Locate files across multiple disks by name, content or Novell attribute. View data from 37 popular programs. Launch, copy, rename, delete, and change attributes. Operates from the command line.

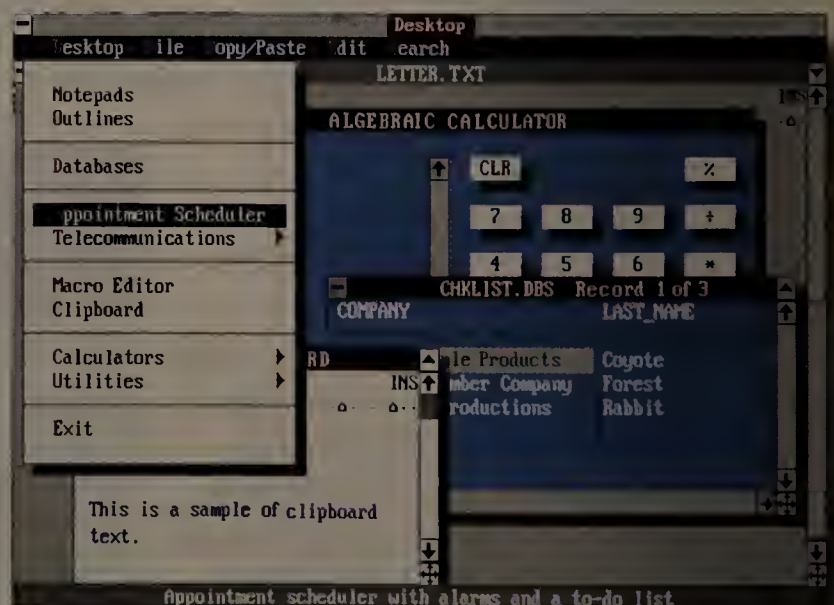
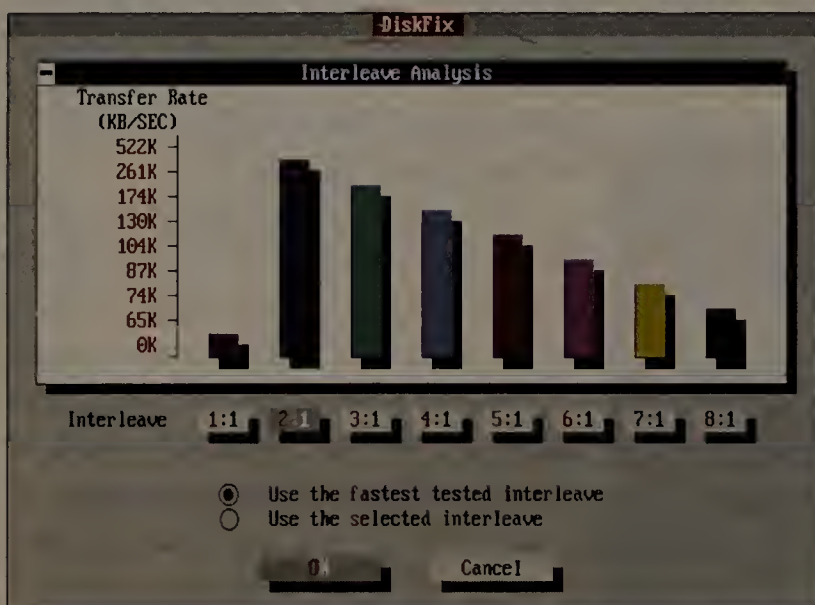

Disk Maintenance and Repair. To help avoid disk crashes and optimize data transfer, our DiskFix™ now does non-destructive, low-level reformatting. DiskFix solves dozens of other disk problems as well.

Desktop Manager. Now includes network-compatible workgroup calendars, a dBASE-compatible database. Telecommunications with advanced MCI Mail support, notepads, calculators and more.

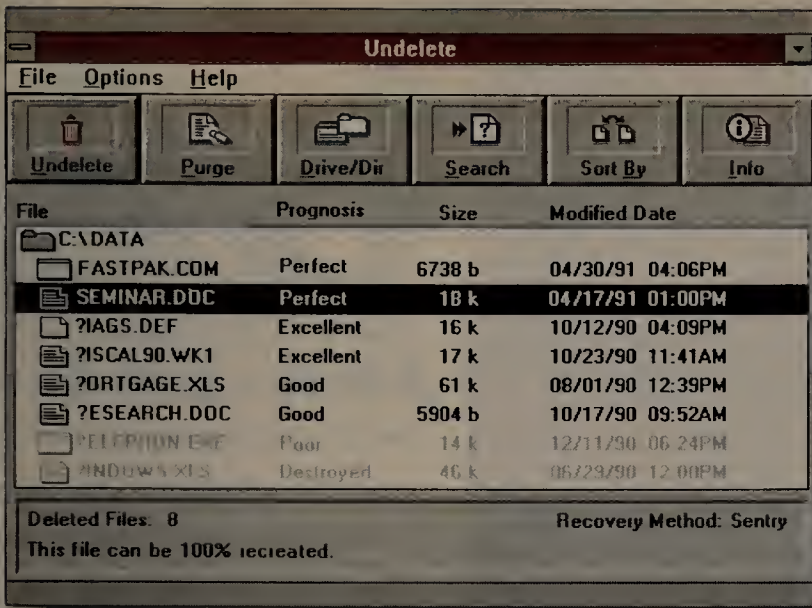

DOS and Windows Undelete. Our new Undelete can save erased files in a protected location - on local or network drives. It's all based on the same undelete technology we licensed to Microsoft for DOS 5.0 - only better.

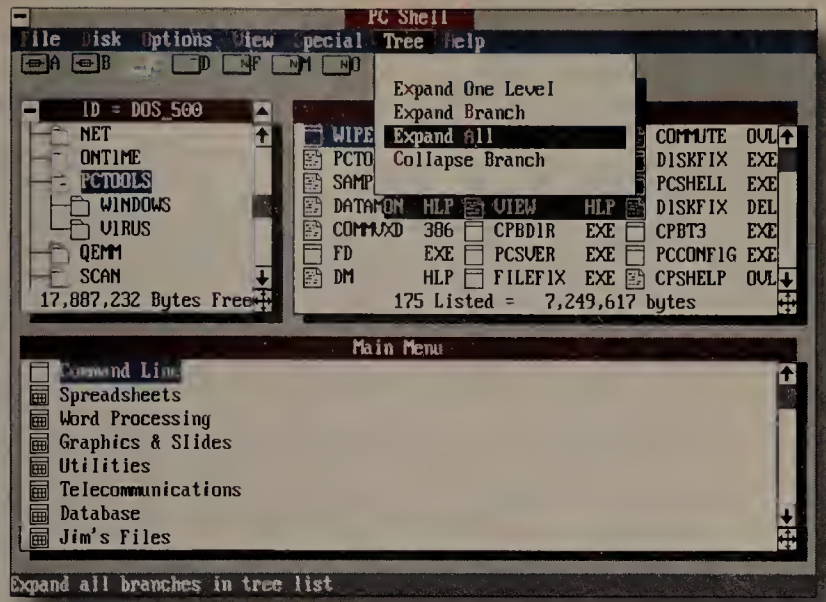

DOS 5.0 Compatible Shell & File Manager. Designed for DOS 5.0 keystroke and menu compatibility, PC Tools 7.0 gives you a powerful system for launching applications and managing your hard disk. Includes viewers for 37 popular programs.

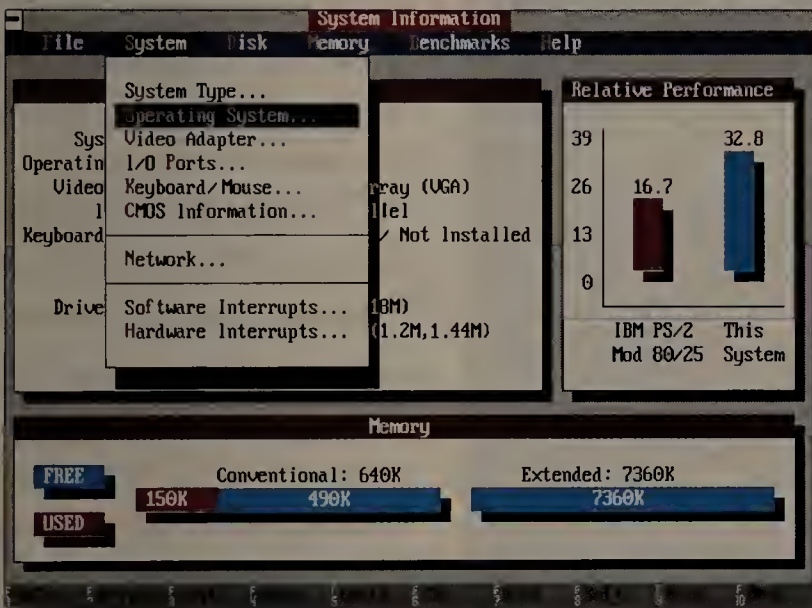

System & Network Information. Reports on over 160 attributes, including video, I/O, memory, mass storage, and four performance benchmarks. On NetWare, SI displays all servers, usage, users, and Novell groups.

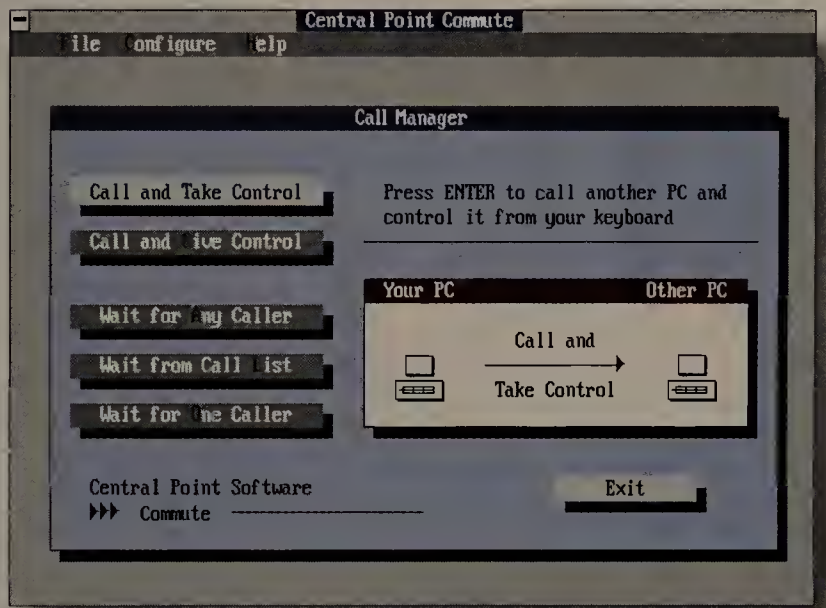

Remote Computing. PC Tools Commute™ lets you take control of another PC, whether you're across town or across the country. Use it over a modem or LAN. You even get remote mouse support for Windows.

Introducing PC Tools™ 7.0.

Whether you're running DOS or Windows, on a network or stand-alone, no single utility can protect and manage your data as completely as PC Tools™ 7.0.

New PC Tools gives you every essential utility in one, integrated package. Like real Windows applications. New remote computing. The only DOS shell with a Microsoft-licensed look and feel. And data recovery that's even better than what we wrote for DOS 5.

Call 1-800-445-4206 for a nearby dealer and get new PC Tools.

Central Point Software INC
Making Computing Safer, Simpler, Faster.

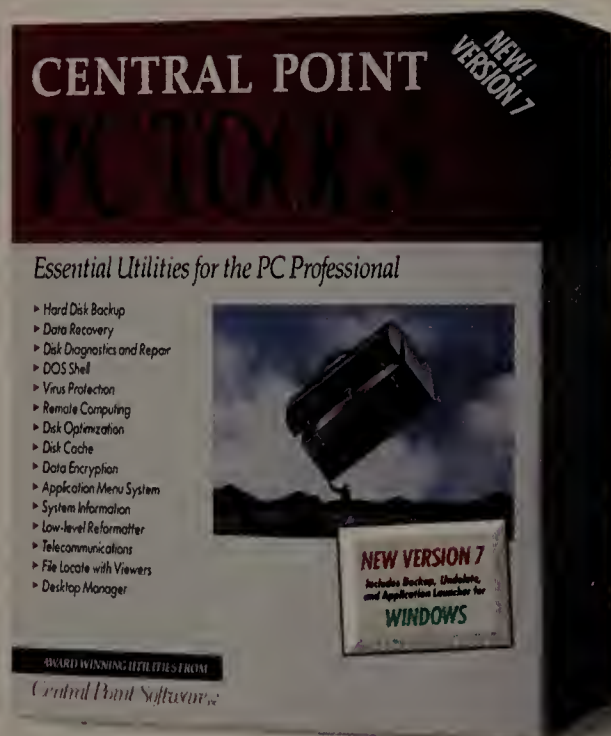

Central Point PC Tools, PC Tools, Central Point Commute and DiskFix are trademarks of Central Point Software, Inc. Names of other products mentioned herein are used for identification purposes only and may be trademarks and/or registered trademarks of their respective companies.

Premium[®] II 486SX/20. Power Tool For The Professional.

Designed For The
New Office Standard.

Today's workplace is a mirror of modern life. Extravagance is out and efficiency is in. High-technology has become commonplace, and personal space is at a minimum. That's why we created the new AST Premium II 486SX/20.

Powered by Intel[®]'s 20 MHz, i486SX microprocessor, the Premium II 486SX/20 features 8 KB of integrated 4-way cache, 4 MB of standard RAM, and full 32-bit address and data buses. And the small-footprint chassis has won the praise of industry critics for its ergonomic design.

As a member of AST's award-winning Cupid-32[™] family of computers, the Premium II 486SX/20 is also fully upgradeable, allowing you to advance to greater power with a simple board swap. And it's backed by AST's top-rated service and support programs.



For information on our Premium II series, call 1-800-876-4AST, or use our electronic bulletin board, AST On-Line!, (714) 727-4723.

AST markets products worldwide; for more information call AST International on (714) 727-9292 or FAX to (714) 727-9360. AST is a supplier to U.S. government agencies, General Service Contract Number GSOOK89AGS6418-PS01. AST, AST logo and Premium registered, Cupid-32 and Cupid-32 logo trademarks AST Research, Inc. All other brand and product names are trademarks or registered trademarks of their respective companies. Copyright © 1991 AST Research, Inc. All rights reserved.

AST[®]
COMPUTERS
The Power Of Choice.

Circle 10 on reader service card



THE HELP SCREEN

PC World offers answers and advice at every level

Run memory-resident programs in Windows, improve 1-2-3's memory management, organize scanned documents, delete unneeded copy protection files, break up an alphabetical list, and move your LAN safely and securely.

Karl Koessel and Robert Lauriston

DOS TSRs and Windows

Q. *Is there a way I can use different drivers and TSRs (memory-resident utilities) with the DOS applications I'm running under Windows 3.0? When running my CAD program under Windows, I'd like to be able to pop up PC Tools' memory-resident DOS shell and calculator and also be able to use the third mouse button (which requires a special driver), but I can't get this setup to work properly.*

Colleen O'Hara

Terre Haute, Indiana

A. Loading a set of memory-resident programs to use with a DOS application

under Windows isn't too difficult. The trick is to set up a PIF file to run a batch file that loads the TSRs and then runs the program. If you can't install your mouse driver from the DOS prompt (and therefore, from a batch file) but must use a DEVICE= command in your system's CONFIG.SYS file, do that first.

To create, say, CAD.PIF, call up the Windows PIF Editor. For the Program Filename, enter `c:\batch\cad.bat` (if you don't keep your batch files in C:\BATCH, replace that string with the appropriate drive and directory). For the Window Title, enter **My CAD Program**. Set the memory requirements as needed, and if you're running Windows in 386-enhanced mode, click the Advanced button and set those options as appropriate.

Now create CAD.BAT; its list of commands should load your mouse driver (unless you've already set the DEVICE= command to do so) and TSRs and then start the CAD program itself. Save CAD.BAT in the directory where you keep your batch files. Finally, use the Program Manager's File New Program Item command, entering `cad.pif` in the Command Line text box, to create an icon for launching your CAD application.

If your application needs more environment space, you can modify CAD.PIF so that it runs COMMAND.COM and then the batch file: For the Program Filename, enter `c:\command.com`; for Optional Parameters, enter `/e:512 /c c:\batch\cad.bat`. The `'/e:512'` gives the DOS session more environment space, and the other parameters cause DOS to run CAD.BAT.

When you're through working in your CAD program, exit it and then

press `<Ctrl>-C` to unload the TSRs and end the DOS session.

Improve 1-2-3's Memory Management

Q. *I have 2MB of RAM in my computer, yet 1-2-3 sometimes gives me a 'Memory Full' message when I load a spreadsheet of only 520K. What takes up the other 1.5MB?*

*Donald L. Johnson
Nashville, Tennessee*

A. When you get that message, you probably have nearly 1MB of expanded memory still free. The problem is that 1-2-3 2.2 and earlier versions require a "pointer" in base memory for each cell that's stored in expanded memory. After you load DOS and 1-2-3 (without a spreadsheet), there's less than 300K of base memory left, so pointers can use it up long before you run out of expanded memory. (Later versions of 1-2-3 avoid the problem through more efficient memory management.) For 2.2 and earlier releases, installing Intex Solutions' *Beyond 640* add-in lets you avoid the pointer problem and use 4MB of expanded memory.

WHERE TO BUY

Beyond 640

Intex Solutions, Inc.
161 Highland Ave.
Needham, MA 02194
617/449-6222, 617/444-2318 (fax)
LIST PRICE: \$95

Reader service no. 745

Organize Scanned Documents

Q. *We're interested in creating an online library of a couple of thousand documents by scanning photographs and Chinese characters into our com-* (continues)

Announcing



Version 7.0

- FULL COLOR SUPPORT
- GLOBAL SEARCH & REPLACE
- AUTOMATIC LINE ROUTING
- OVER 270 OUTPUT DEVICES SUPPORTED
- NOVELL SUPPORT
- 3D CHARTING
- USER FRIENDLY
- FAST

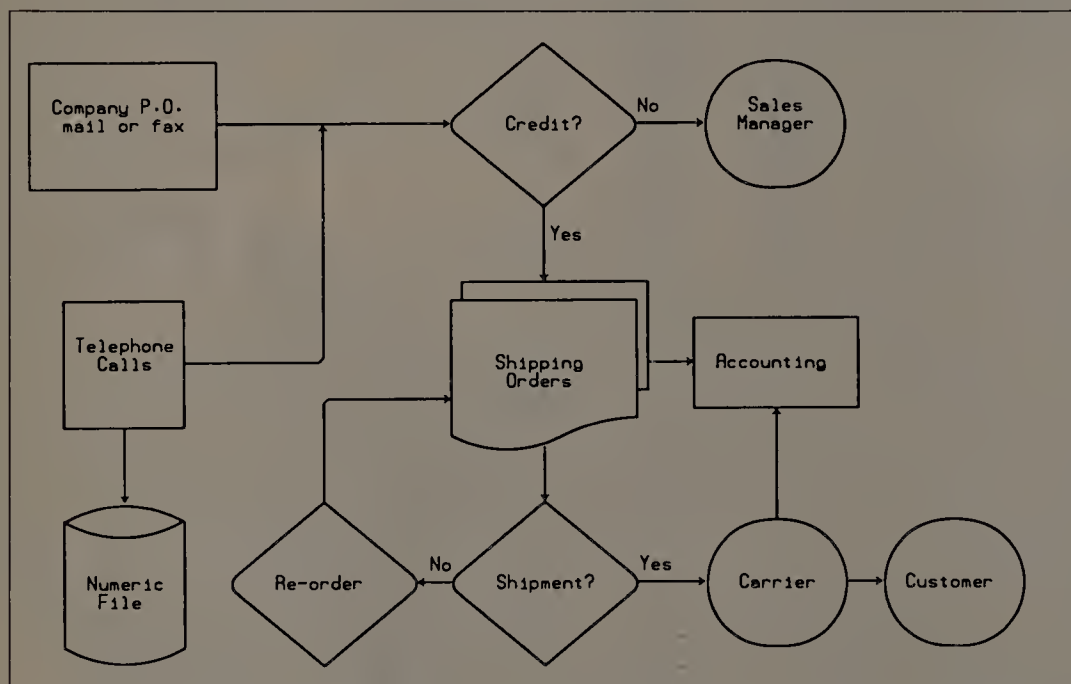

In any business there are processes and procedures that must be documented. EasyFlow is a powerful program dedicated to the fast creation and modification of flowcharts, data-flow diagrams and organization charts. Unprecedented support for a wide range of desktop publishing and graphics programs allows for easy integration of charts into larger documentation. Alternate shape libraries for accounting diagrams, networking diagrams and fault-tree diagrams expand the usefulness of the program and are available for an additional cost. Ease of use, flexibility and speed along with FREE technical support and a NO RISK 30 Day Money Back Guarantee all combine to make EasyFlow the industry leader and corporate standard.

Special Introductory Offer \$230

Plus Shipping

ORDER HOTLINE **1-800-267-0668**



HavenTree Software Limited
P.O. Box 1093 - M
Thousand Island Park, NY 13692
Information: (613) 544-6035 ext.47
Fax: (613) 544-9632

THE HELP SCREEN

puter. We'd like to be able to search for documents by customer name or case number, then view them. Is our 286 clone with 640K of RAM, a 40MB hard disk, and Hercules graphics up to the job? What software do we need?

Betty Chin

Seattle, Washington

A. *Hotshot Imagebase* is one application we've found that lets you easily organize and display scanned images. But it doesn't support Hercules graphics, so you'll need to upgrade to a VGA video board and a VGA monitor. If your photographs are black and white, you won't really need color—a monochrome VGA monitor will do fine. Because each full-page scanned document can take up to 180K, you'll need about 18MB of free hard disk space for each 100 images. For 2000 scanned documents, you'll need a 600MB hard disk (a 300MB disk would probably hold only about 1500; the next size up is 600MB).

So, your system would be able to handle the job—once you have upgraded its hard disk, video board, and monitor. Given today's prices, consider selling your AT clone and buying a system that's configured to meet your needs. Also, if retrieval speed is not critical, consider an internal or external Bernoulli, which uses 44MB removable cartridges. You may find the savings over a 600MB hard drive attractive.

WHERE TO BUY

Bernoulli Dual 44, Partner 44

lomega Corp.
1821 West 4000 South
Roy, UT 84067
801/456-5522
LIST PRICE: Dual 44 \$2399, Partner 44
\$859, Tri-Pack of cartridges \$140
Reader service no. 774

Hotshot Imagebase

Symsoft
916 Southwood Blvd.
Call Box 5
Incline Village, NV 89450
702/832-4300
LIST PRICE: \$149
Reader service no. 746

(continues)

A sale of encyclopedic proportions.

Save \$500!

CALL 1-800-NEC-INFO

THE TIME TABLE OF HISTORY: SCIENCE AND INNOVATION

A far-extending 6,000 story compendium from Xiphias of key events in science and technology. From the Big Bang to the Super Collider, all entries are completely cross-referenced with 1,000 multi-media graphics and stereo effects. It's the fifth best-selling CD-ROM product on the market!

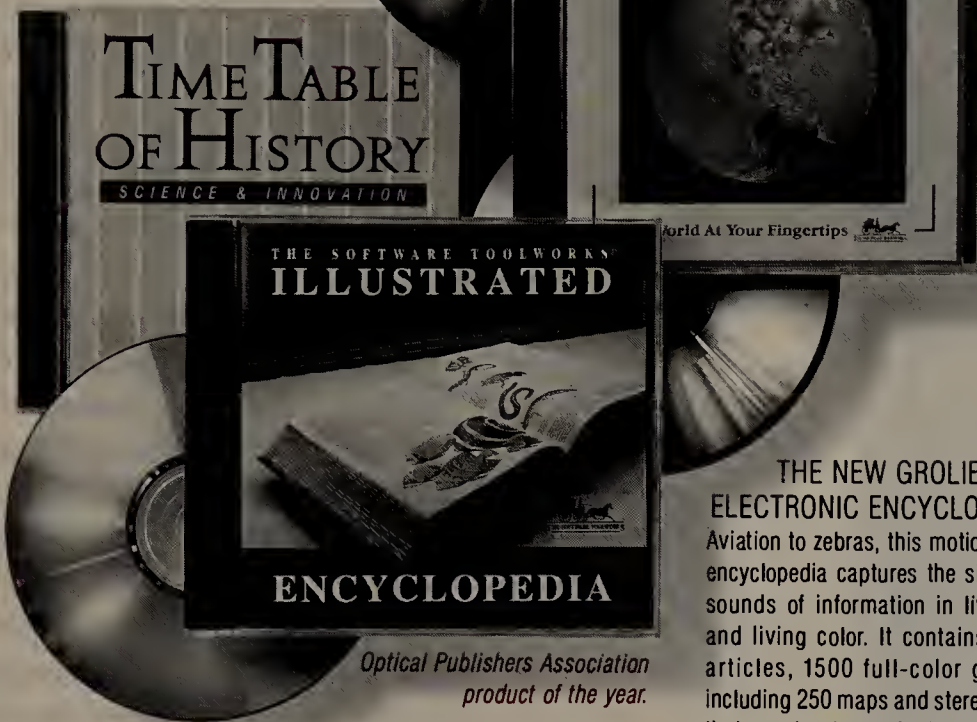

*Optical Publishers Association
product of the year.*

THE SOFTWARE TOOLWORKS® WORLD ATLAS

You've got the whole world at your fingertips with the finest interactive printable CD-ROM that puts you just a "click" away from 240 maps of the world, individual countries, regions and counties. Incorporating geographic, demographic, economic, government and communications data in a brilliant presentation will get high marks with this indispensable Atlas/Almanac world fact book.

THE NEW GROLIER ELECTRONIC ENCYCLOPEDIA™

Aviation to zebras, this motion-picture encyclopedia captures the sights and sounds of information in live-action and living color. It contains 33,000 articles, 1500 full-color graphics including 250 maps and stereo sounds that speak volumes for its capabilities. "Best encyclopedia on CD." *PC Computing*. "Second best selling CD-ROM product on the market." *Bureau of Electronic Publishing*.



© 1991 NEC TECHNOLOGIES, INC.

Very rarely does a new product come along that turns an industry on its ear.  Such is the case of CD-ROM with its massive capacity that allows you to experience the exhilaration of video animation, living color, sound and special effects. So you're in for one of the most exciting interactive, sensory experiences you've ever had sitting

down.  Get three of the current top ten CD-ROM software titles: *The New Grolier Electronic*

Encyclopedia,™ *The Time Table of History*, and *The Software Toolworks® World Atlas*, with your special discounted purchase of the high-performance NEC Intersect™ CDR-36 portable CD-ROM reader. 

The New Grolier Electronic Encyclopedia™ is a trademark of Grolier Incorporated.

Act now and save \$500* from the manufacturer's suggested retail price on this exclusive package at just \$749* for Macintosh and \$849* for IBM AT/XT and

The Software Toolworks® is a registered trademark of The Software Toolworks, Inc.

\$899* for PS2.  This essential reference package includes an Interface Kit for either Macintosh or IBM, headphones

Time Table of History is a trademark of Xiphias, Inc.

with CD-audio software diskette to play stereo music CD's, and quick-inst all program diskette. The big plus is toll-free telephone access to the NEC hotline for hardware or software technical assistance and a 2-year limited hardware

Intersect is a trademark™ of NEC Technologies, Inc.

warranty.  But be mindful. While your mental capacity may be limitless, the supplies for this promotion are limited.

IBM, XT, AT and PS/2 are registered trademarks of the International Business Machines Corp.

If you're ready to expand your horizons, call today, **1-800-NEC-INFO** and ask for *Encyclopedias* to get the nearest

Macintosh is a registered trademark of Apple Computer, Inc.

participating CD-ROM dealer or distributor before January 15, 1992. *Suggested retail price, actual price may change depending on dealer.

for Windows

After Dark

The Ultimate Screen Saver Collection

#1 Screen Saver

*now available for Windows

Over 35 entertaining displays to prevent phosphor burn-in

Create your own displays with logos and other graphics

Password protection

DOS blanking

Network compatibility

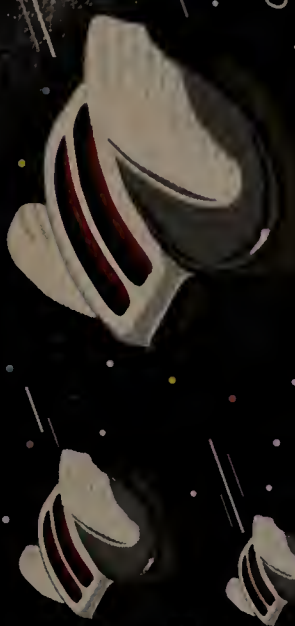

ONLY \$49.95

BERKELEY SYSTEMS

Berkeley Systems, Inc.
1700 Shattuck Ave.
Berkeley, CA 94709
415.540.5535

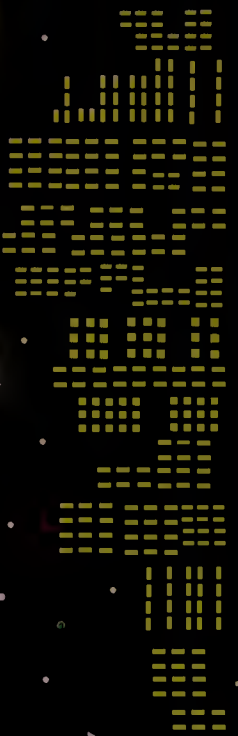

Circle 32 on reader service card

THE HELP SCREEN

```
{LET A1,@CELLPOINTER("contents")}
{IF @ISNUMBER(A1)}{QUIT}
{DOWN}
{IF (@LEFT(A1,1))<(@LEFT(@CELLPOINTER("contents"),1))}{/ Row;Insert}~ {DOWN}
{BRANCH NAMELIST}
```

FIGURE 1: This Quattro Pro macro runs through an alphabetically sorted list and inserts a blank row between the A's and B's, B's and C's, and so on.

Delete Unneeded Copy Protection Files

Q. *I've been trying to remove an old copy-protected program from my hard disk. I used a freeware utility to reveal its hidden files, but when I try to delete them I get the message 'Access denied'. Is there some way I can get rid of these files?*

*Kenneth Kramer
Colorado Springs, Colorado*

A. Those files are not only hidden, they're probably also set as "read only." Use the DOS command ATTRIB to shut off the read-only attribute, and you should be able to erase them. For example, if the troublesome file is called PROTECT.FIL, you'd enter `attrib -r protect.fil` at the C> prompt. If you're using an old version of DOS without ATTRIB (it was added in 3.0), try a shareware or commercial collection of disk utilities; most can also reset the read-only attribute.

Break Up an Alphabetical List

Q. *To make an alphabetical list of names more readable, I insert a blank row between the A's and B's, B's and C's, and so on. Can I use a Quattro Pro macro to automate this task?*

*E. W. Kennedy
Whispering Pines, North Carolina*

A. The five-line macro shown in FIGURE 1 does the trick. You'll need to assign one cell in the worksheet as a work area for the macro. Here we've used A1, but you can replace that with any cell or one-cell range name in the worksheet away from the list of names, or a cell or range name in the file that holds your macro library. Be sure that you don't add any characters, including trailing blanks, to any of

the macro lines. To use the macro, make sure there are no blank lines before the end of the list and that the list is sorted. Then position the cell pointer on the first cell of the name list, and run the macro. First, the macro copies the contents of the current cell to the work cell. To avoid getting into an endless loop, it then checks to see if the work cell is a number (since a blank line is seen as a zero), in which case it stops running. Otherwise, it moves down to the next cell in the list. The next command checks to see if the first character of the work cell is "less" (has a lower ASCII value) than the first character of the now-current cell. If so, *(continues)*

POWER TIP NO. 194

List All of the Directories All the Time...

You can list most subdirectories by entering `dir *` at a directory's DOS prompt, but your list will include files without extensions and won't include subdirectories with extensions. Enter `dir | find "<DIR>"` at the DOS prompt if you want to list the names of all the subdirectories in the current directory. To make the process even easier, put the command in a batch file with a memorable name, such as SUB.BAT or SUBDIR.BAT.

*R. D. Rathod
Littleton, Colorado*

There's No Way Around Your Business Accounting, But Here's a Great Way To Get Through It.

Full-Featured, Easy-to-Use Accounting from DacEasy

DacEasy™ Accounting won't do your accounting for you, but it will make it easier to manage.

With hundreds of powerful features and a user interface that works the way your business works, DacEasy Accounting has earned the most industry awards and is the accounting system of choice for over 700,000 businesses worldwide.

DacEasy Accounting General Features

- Unlimited transactions,
- Context-sensitive & indexed help
- Instant lookup capability
- Mouse support (optional)
- Built-in backup/restore routines
- Recurring transaction option
- Complete line of forms & checks available

General Ledger

- Modifiable sample chart of accounts
- Allows 13 user defined periods
- Allows up to 18 months open
- Auto-reversing transactions

Accounts Receivable

- Open invoice/balance forward/cash
- Flexible aging reports
- Automatic finance charges
- Supports partial payments

Accounts Payable

- Prints 1099 (Misc)
- Multiple checking accounts

Cash Management

- Handles deposits, prints checks
- Account reconciliation
- Writes checks from G.L.

Billing

- Unlimited number of sales tax rates
- Sales journals & credit memos
- Automatic revenue and cost allocation by dept.
- Point-of-sale invoicing
- Sales analysis report

Inventory

- Supports last purchase, average and standard costing

Product Assembly

- Internal product building before billing
- Unlimited number of items per product

Purchase Order

- Multiple tax rates per vendor
- Purchase journal/unlimited items per P.O.

Budgeting

- Monthly budgeting
- Year-to-date comparison

3-D Graphics

- Bar, 3-D bar, 3-D pie, line, stacked bar, overlay bar, high/low close combination line and bar, & filled line graph capability
- Dual orientation capability
- Supports 150 different printers

Management Reporting

- Builds custom reports using any field
- Generates reports from master files
- View reports on screen

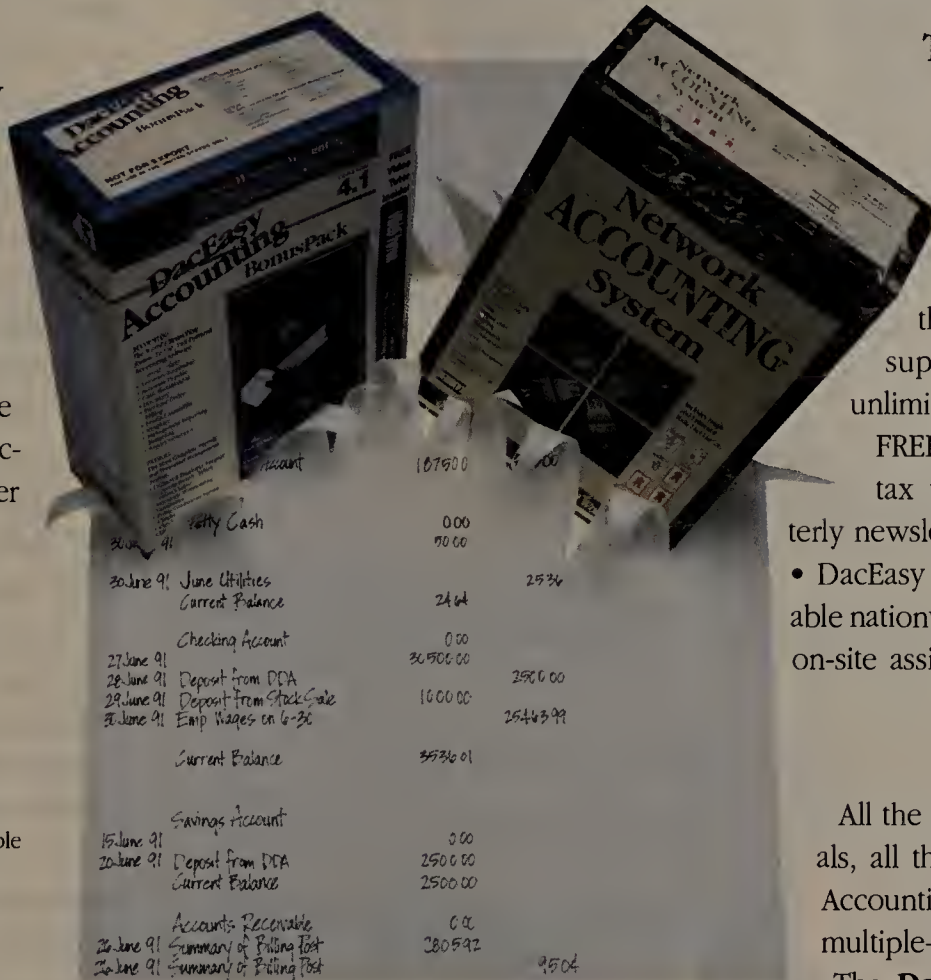

The Support You Need, When You Need It

DacEasy offers the best in telephone and on-site support programs.

- The DacEasy Advantage Club, the best in complete, affordable support, provides a full year of unlimited telephone assistance, plus FREE maintenance revisions, FREE tax updates, an informative quarterly newsletter, and more.
- DacEasy Certified Consultants are available nationwide by referral for customized, on-site assistance.

Complete Network Accounting, Too

All the features, all the training materials, all the support options of DacEasy Accounting are available in a powerful, multiple-user version.

The **DacEasy Network Accounting System** has everything you get with the BonusPack in a Local Area Network format that offers these powerful network features:

- Unlimited number of users
- Custom password protection
- Support for up to six printers

And, the DacEasy Network Accounting System is priced at just **\$499.95**.

To get the best award-winning accounting features, plus the most Training and Support plans for your business, ask your local software dealer for DacEasy Accounting, or call DacEasy toll free today.

1-800-877-8088

For Canadian Version with GST call
(416) 940-3314

DacEasy, Inc.

17950 Preston Rd. • Ste. 800 • Dallas, Texas 75252
30 Day Money-Back Guarantee

DacEasy software is backed by a full, money-back guarantee within 30 days, when purchased directly from DacEasy.

Hardware Requirements: IBM or compatible PC's, Accounting 4.1-640K, Hard Disk, DOS 3.1 or later, mouse optional. Payroll 4.1-512K, Hard Disk, DOS 3.1 or later, mouse optional. Network Accounting-NetBIOS Compatible LAN, 640K, DOS 3.1 or later, mouse optional. Rolodex is a trademark of Rolodex Corp. DacEasy is a trademark of DacEasy, Inc. © Copyright 1991. All rights reserved.

* Editor's Choice 1985 for Version 1.0, 1987 for Version 2.0.

DacEasy Payroll

- Prints continuous payroll checks, W-2's, 1099 (MISC) forms
- Supports hourly, salaried and contract labor
- Automatic Federal & State withholding
- Creates W-2's on magnetic media
- Tracks hire dates, raises, vacation, etc.
- Fast check reconciliation
- Supports cafeteria plan

DacEasy Video Tutor

- Covers DacEasy Accounting and Payroll

The **DacEasy BonusPack** includes DacEasy Accounting, Payroll and the Video Tutor, all for just **\$229.95**.

More Training Options

DacEasy makes it easy to quickly get productive with DacEasy Accounting with training programs and materials unequalled in the industry.

- Classroom Seminars are offered in cities all across the Nation, providing hands-on instruction from a qualified professional DacEasy Accounting specialist.
- Self-paced training materials are convenient and economical for on-site learning and employee training.
- The DacEasy Video Tutor is a great way to get a quick start with DacEasy Accounting.



MEDIA CODE: PCW

Circle 94 on reader service card



All video display terminals (VDTs) emit electromagnetic radiation (EMR) through the screen. The photo on the left is a visualization of EMR in red from the screen. The photo on the right shows that the NoRad Shield™ virtually eliminates screen-emitted E-Field EMR and better than half of magnetic EMR.*

NoRad Radiation Shield

No One Comes Close

E-FIELD SHIELDING TECHNOLOGY COMPARISON TO 1 GHz



CARBON MESH

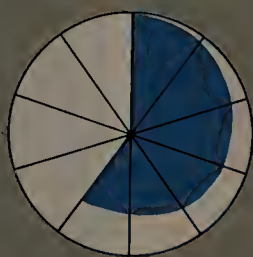

GLASS/ACRYLIC



NORAD SHIELD

Figures are based on independent lab tests conducted to Military Specification MIL-STD 285 of the NoRad Shield™ and other commercially available radiation-blocking screens.

No other VDT screen comes close to the NoRad Shield when you're talking about blocking electromagnetic radiation (EMR). If you're thinking of buying a radiation shield, consider the facts:

- Only the NoRad Shield blocks virtually all E-Field EMR*
- Only the NoRad Shield blocks magnetic EMR*
- And, the NoRad Shield discharges the static field while eliminating glare and reflections.

The NoRad Shield – simply the best radiation shield available. Compare and you'll see that no one else even comes close. Call for free product information.



- Easy to install
- Color or monochrome
- Available in sizes to fit virtually all monitors, displays and terminals

*99.9999% electric (E field) attenuation from 60 Hz to 1 GHz.
*Greater than 50% magnetic (H field) attenuation above 30 KHz.
NoRad Shield is a trademark of NoRad Corporation.

NoRad

IN USA:
800-262-3260

NoRad Corporation 1549 11th St.
Santa Monica, CA 90401

213-395-0800

Fax: 213-458-6397

the pointer is at the beginning of the next alphabetic section, and the macro inserts a blank row and moves down a cell. Then it loops back to continue running the macro from the beginning. (If you don't want to name the macro NAMELIST, revise the last line to branch to the name you want to use.)

1-2-3 users can also use this macro if they make one modification: Replace '{/ Row;Insert}~' with /WIR~ to tell 1-2-3 to insert a row.

How does...? What can...? Should I...? Send your PC questions to The Help Screen, PC World, 501 Second St. #600, San Francisco, CA 94107-1431; CompuServe 74055,412; MCI Mail PC World Editorial; or 415/442-1891 (fax). Questions with the broadest appeal will be published. ☉

Karl Koessel is the technical editor and Robert Lauriston a contributing editor for PC World.

POWER TIP NO. 195

Crossing Borders in 1-2-3

1-2-3's Worksheet Titles Horizontal, Vertical, and Both commands help keep your place by displaying titles on the edges of the screen as you scroll through large worksheets. But they also prevent you from getting into the titles area using just the cursor keys. To move your cursor into the titles area, press the GoTo key (<F5>) and specify the address cell. Or press <F5>, use the cursor keys to point to the cell, and press <Enter>. Once you're inside the titles area, you can cursor to any cell to make needed changes.

Rex Farrance
Assistant Editor

Circle 180 on reader service card

NETWORK Q & A

Make Moving Your LAN as Safe and Painless as Possible

Keith Nickerson

Q. *We're moving to new offices at the end of the year, and I'm worried that our server and workstations won't survive the trip intact. I'm also concerned that the LAN might not work properly at the new location. Can you give me any advice on how to avoid trouble?*

*Barbara Gunderson
Council Bluffs, Iowa*

A. Moving a LAN isn't easy, and without proper care it can become a frustrating ordeal. Here are some simple steps you can take to smooth your move.

Choose a mover that's specially equipped to move computers. Most large moving companies do have the proper padded cabinets to house and protect your machines during the move. Also, note that some computers' warranties require you to move the system in its original packing.

Hire an established, reputable company to lay the network cables in your new location or to check those already in place (it's easier to check disconnected cable segments for faults than it is to troubleshoot problems after everything's connected). Cut corners here, and you'll burn up more time and money fixing problems than you would have spent on a quality job in the first place.

Be sure you have adequate phone jacks, power lines, and ventilation in your new file server room. If you aren't planning the move yourself, make sure the planner is aware of and understands your requirements. If your new building has professional management, they should be able to calculate the required cooling from a list of how many and what types of machines you'll be housing there (the temperature should not exceed about 75 degrees). Large floor fans are a bad idea, as they spread dust and dirt that can seriously damage your

machines.

Plan to take down your server at least one day before the move so the equipment can cool overnight. Warn your users well ahead of the appointed hour, and make sure they understand they may lose some of their work if they're logged in and have files open on the server when you take it down. Also, remind your users of their responsibility to back up their local hard drives. You don't want to be blamed for any data being lost during the move.

Fifteen minutes before you power down the server, use NetWare's SEND utility to warn users to save their work and log out. Send two more messages at 5-minute intervals before you finally shut down. Enter **disable login** at the file server console to prevent users from logging in, then use FCONSOLE (in NetWare 2.x) or MONITOR (in NetWare 3.x) to log out any users still connected.

When all user connections have been terminated and all files are closed, make at least two complete, verified backups of the file server.

Be certain all the workstations' hard drives are "parked" before you unplug them for packing. Most newer PCs do this automatically when the machine is shut down, but with older machines you'll have to park the drives manually.

Tape all power cords and other cables to the appropriate CPU or printer before the movers pack them away. That way you won't have to hunt for them when you're unpacking.

Keep an eye on your file servers as the movers pack and unpack them. Movers are often not fully aware of the delicacy and value of the equipment they're moving, and a word of advice at the right time can save expensive trouble later.

Even with the best of planning, something can always go wrong. Be sure all

your equipment is properly insured against damage during the move.

Finally, allow plenty of time to get things up and running again in your new offices. It's almost certain to take longer than you expect. ☹

Keith Nickerson is the editor of NetWare Advisor and a member of the publishing team at Business Systems Group, a Houston-based systems integration firm.

POWER TIP NO. 196

Save Space and Display Large Values in Excel

When a column isn't wide enough to display formatted values in a worksheet, Excel fills the column with '#####'. But if you convert the value to text using the TEXT function, it will display in a narrow column, with the excess displaying if the cells to the right are empty.

Suppose you want to display the current date and time at the top of your worksheet but don't want to set a column wide enough to display 'January 15, 1991, 11:05 PM' as a value. Just enter the formula `=text(now(),"mmmm d, yyyy, h:mm am/pm")` into a cell of any width greater than zero, and then align the text as you wish. The date will be displayed in its entirety, allowing you to maintain narrow columns.

*Charles W. Kyd
Lynwood, Washington*

PostScript® language solutions for LaserJet® printers haven't exactly set records for speed.

But times have changed.

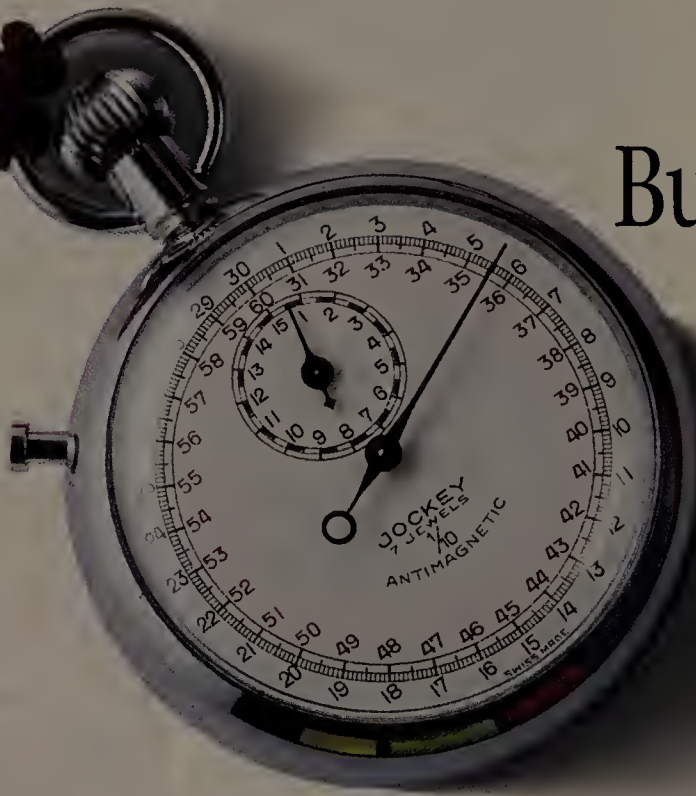

In the past, patience has been a necessity when printing PostScript language quality graphics and text on your LaserJet IIP, III, IIID, or IIIP laser printer.

Introducing PacificPage XL™— it will change the way you look at PostScript language emulation products, both in price and performance. That's because PacificPage XL offers PostScript compatible output in record time for a price lower than competitive products.

PacificPage XL provides the newest version of our PacificPage P•E cartridge and a high speed accelerator board that installs easily into the LaserJet's printer memory slot. It includes an Intel i960 KB RISC microprocessor and 2 MB of memory "on board". No additional memory is required.

Compare it to the Hewlett-Packard PostScript language solution. For their cartridge

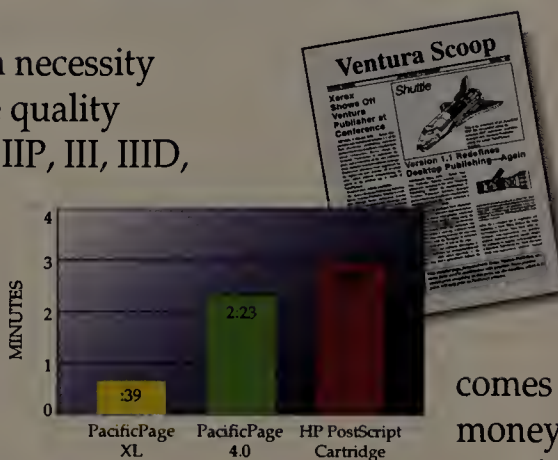

and 2 MB of printer memory you would spend \$1085. While PacificPage XL sells for the low price of \$999 and produces output 2 to 8 times faster than the HP cartridge solution. And, PacificPage XL comes with a lifetime warranty and a money back guarantee of satisfaction.

If you're looking for a change of pace in PostScript language solutions for the HP LaserJet printer, call your nearest dealer or contact Pacific Data Products, 9125 Rehco Road, San Diego, California 92121, USA. (619) 597-4630, Fax (619) 552-0889.



PACIFIC
DATA PRODUCTS



All prices are U.S. list effective 2/15/91. For time comparisons, PostScript solutions installed on LaserJet III printer connected via parallel cable to NEC 386 25 Mhz personal computer. All printer times measured from hitting "Enter" key to engine start-up. PacificPage XL and PacificPage P•E are trademarks of Pacific Data Products, Inc. i960 is a trademark of Intel Corporation. PhoenixPage is a registered trademark of Phoenix Technologies Ltd. Copyright 1987, 1988 Phoenix Technologies Ltd. HP, LaserJet and Resolution Enhancement are registered trademarks of Hewlett-Packard Co. PostScript is a registered trademarks of Adobe Systems Incorporated. EUROPEAN HEADQUARTERS: Switzerland Tel (41) 22-412650, Fax (41) 22-410682. © 1991 Pacific Data Products.



CONSUMER WATCH

Advice and information for the computer consumer

National Guide to User Groups

Roberta Furger

Whether you'd like information on new products, fellowship with other PC users, or training on the latest hardware and software, chances are you'd benefit by hooking up with a PC user group.

To that end, we've updated our annual list of user groups in the United States. Our thanks to the Association of PC User Groups (APCUG), a Washington, D.C., umbrella organization for user groups, and to Fog International Computer Users Group, for their assistance in compiling the listing.

Our apologies if your group is not listed. We included only groups whose information we could verify with a member. If you don't see your group in the following pages, send us the details, and we'll include you in our next list.

ABBREVIATIONS KEY

NL: newsletter
SIG: special interest group
TS: technical support
TE: training and education
SL: software library
BBS: bulletin board system

(Groups listed alphabetically by state and city.)

ALABAMA

Birmingham IBM PC User Group
 P.O. Box 19248
 Birmingham, AL 35219-9248
 205/871-1939
 \$20/yr.; NL, 8 SIGs, TS, TE, SL

Huntsville IBM PC Users
 P.O. Box 16013
 Huntsville, AL 35802
 205/539-5940
 \$20/yr.; NL, 4 SIGs, TE, SL, BBS

ALASKA

Polar PC User Group
 P.O. Box 72934
 Fairbanks, AK 99707
 907/452-2500
 \$10/yr.; NL, TS, TE, SL

ARIZONA

Phoenix PC Users
 P.O. Box 35637
 Phoenix, AZ 85069-5637
 602/943-7907
 \$40/yr.; NL, 7 SIGs, TS, TE, SL, BBS

South Mountain Users
 P.O. Box 50002
 Phoenix, AZ 85076
 602/963-2989
 \$30/yr.; NL, 5 SIGs, TS, SL

Tucson Computer Society
 P.O. Box 1489
 Tucson, AZ 85702
 602/577-3261
 \$24/yr.; NL, 15 SIGs, TS, TE, SL, BBS

ARKANSAS

Arkansas/Oklahoma PC Users Group
 P.O. Box 853
 Fort Smith, AR 72902-0853
 501/784-8400
 \$20/yr.; NL, 4 SIGs, TS, TE, BBS

Central Arkansas PC Users Association

P.O. Box 2095
 Little Rock, AR 72203
 501/225-9304
 \$24/yr.; NL, TS, SL, BBS

Twin Lakes Computer Users Group
 Rt. 5, Box 127
 Mountain Home, AR 72653
 501/425-9061
 \$15/yr.; NL, TS, TE, SL, BBS

NW Arkansas Microcomputer Users
 Rt. 4, Box 376
 Springdale, AR 72764-9307
 501/361-2963
 \$15/yr.; NL, TS, TE, SL

Jonesboro User Group
 P.O. Box 838
 State University, AR 72467
 501/935-6659
 \$12/yr.; NL, 4 SIGs, TE, TS, SL, BBS

CALIFORNIA

Berkeley PC/Compatibles Users
 c/o Mel Mann
 1145 Walnut St.
 Berkeley, CA 94707
 415/526-4033
 No fee; NL, TS, TE, SL, BBS

Valley Computer Club
 P.O. Box 6008
 Burbank, CA 91510-6008
 818/842-3707
 \$25/yr.; NL, 3 SIGs, TE, SL, BBS

Fog International Computer Users
 P.O. Box 3474
 Daly City, CA 94015
 415/755-2000 (days)
 \$30/yr.; NL, 4 SIGs, TS, TE, BBS

Color America, Inc.
 c/o Robert Marvin

1466 Spruce Tree Dr.
 Diamond Bar, CA 91765
 714/861-2949
 \$20/yr.; NL, 2 SIGs, BBS

IBM Humboldt Users
 P.O. Box 6721
 Eureka, CA 95502
 707/442-4621
 \$27 first year, \$12/yr. thereafter; NL, 2 SIGs, TS, TE, SL

Microlink PCUG
 c/o Bob Discount
 15865-B Gale Ave.
 #1003
 Hacienda Heights, CA 91745
 818/917-6470
 \$25/yr.; NL, SL, BBS

Antelope Valley Microcomputer Users
 P.O. Box 2942
 Lancaster, CA 93539
 805/948-5166
 \$20/yr., \$10 initiation fee; NL, TS, TE, SL

San Luis Obispo PC Users Group
 c/o Bob Ward
 2100 Andre Ave.
 Los Osos, CA 93402
 805/528-0121
 \$20/yr.; NL, 2 SIGs, TS, TE, SL, BBS

Monterey Bay Users
 c/o Lee Keely
 177 Webster St. #A354
 Monterey, CA 93940
 408/373-6245
 \$25/yr.; NL, 2 SIGs, TS, TE, SL

Napa Valley PC Users
 P.O. Box 2653
 Napa, CA 94558
 707/255-9241
 \$15/yr.; NL, TS, SL, BBS

Channel Islands PC Users' Group
 P.O. Box 5025
 (continues)

Oxnard, CA 93031
805/983-4741
\$20/yr.; NL, 2 SIGs, TS,
TE, SL, BBS

Pasadena IBM Users
Group
c/o Steve Bass
711 E. Walnut St. #306
Pasadena, CA 91101
818/795-2300 (days)
\$42/yr.; NL, 9 SIGs, TS,
TE, BBS

Riverside IBM Computer
Club
c/o James Heidecke
7860 Live Oak Dr.
Riverside, CA
92509-5339
714/685-5407
\$25/yr.; NL, TS, TE, BBS

Sacramento PC Users
c/o Milt Hull
P.O. Box 162227
Sacramento, CA
95816-2227
916/386-9865
\$25/yr.; NL, 25 SIGs,
TS, TE, SL, BBS

Inland Empire
Computer Group
P.O. Box 5281
San Bernardino, CA
92412-5281
714/864-3093
\$20/yr.; NL, SL, BBS

San Diego Computer
Society
P.O. Box 81444
San Diego, CA 92138
619/549-3787
\$25/yr.; NL, 20 SIGs,
TS, TE, SL, BBS

San Francisco Business
Computers
c/o Jordan Rosenberg
455 Vallejo St.
San Francisco, CA
94133
415/788-5338
No fee; NL, TS, BBS

San Francisco
Computer Society
P.O. Box 783
San Francisco, CA
94101
415/929-0252
\$30/yr.; TS, TE, SL

San Francisco PC Users
Group
3145 Geary Blvd. #155
San Francisco, CA
94118-3316

415/221-9166
\$35/yr.; NL, 19 SIGs,
TS, TE, SL, BBS

Santa Barbara PC Users
Group
c/o Wayne McCall
281 Oak Rd.
Santa Barbara, CA
93108
805/969-9961
\$20/yr.; NL, 7 SIGs, TS,
TE, SL, BBS

Silicon Valley Computer
Society
c/o Bert Stephens
2464 El Camino Real
#190
Santa Clara, CA 95051
408/286-1271
\$30/yr.; NL, 17 SIGs,
TS, TE, BBS

North Bay Users
P.O. Box 7156
Vallejo, CA 94590
707/644-9327
\$18 first year, \$15/yr.
thereafter; NL, 5 SIGs,
TS, TE, SL, BBS

COLORADO
Metro Area Computer
Enthusiasts
P.O. Box 440247
Aurora, CO 80044
303/830-9143
\$20/yr.; NL, 2 SIGs, TS,
TE, SL, BBS

Colorado Springs PC
Users Group
P.O. Box 1028
Colorado Springs, CO
80901
719/596-6938
\$30/yr.; 3 SIGs, TS, TE,
SL, BBS

Mile High Computer
Resource Organization
P.O. Box 5226
Denver, CO 80217
303/286-7455
\$25 first year, \$20/yr.
thereafter; NL, 2 SIGs,
TS, TE, SL, BBS

Windows on the Rockies
User Group
P.O. Box 9929
Denver, CO
80209-0929
303/733-1277
\$30/yr. (corporations
\$60/yr.); NL, TS, SL

Front Range PC Users
c/o Rick Mattingly
305 W. Magnolia #152

Fort Collins, CO 80521
303/223-8654
\$25/yr.; NL, 6 SIGs, TS,
TE, SL, BBS

Chaffee County
Computer Club
P.O. Box 1123
Salida, CO 81201
719/539-3884
\$18/yr.; NL, TS

CONNECTICUT
Central CT PC (PCjr)
Group
c/o Bob Gauthier
781 Main St.
Coventry, CT 06238
203/742-6083
\$6/yr.; NL, SIG, TS, TE,
SL

Connecticut IBM PC
Users' Group
P.O. Box 291
New Canaan, CT
06840
203/762-0229
\$25/yr.; NL, 6 SIGs, TS,
SL, BBS

Trumbull PC Users
P.O. Box 545
Trumbull, CT 06611
203/334-4267
\$20/yr.; NL, 3 SIGs, TE,
SL, BBS

Business & Professional
Micro Users Group
P.O. Box 1468
West Hartford, CT
06107
203/242-6587
\$15/yr.; NL, 2 SIGs, TS,
TE

DELAWARE
PC Professional Users
c/o Glenn Bleakney
1601 Concord Pike
Wilmington, DE 19803
302/656-8200
\$20/yr.; NL, 4 SIGs, SL,
BBS

**DISTRICT OF
COLUMBIA**
Capital PC Users
51 Monroe St.,
Plaza E. #2
Rockville, MD 20850
301/762-6775
\$35/yr.; NL, 35 SIGs,
TS, TE, SL, BBS

Association of PC User
Groups, Inc. (APCUG)
1730 M St. NW #700
Washington, DC 20036

FLORIDA
Polk IBM PC Users
c/o Steve LaLonde
2182 Lake Ariana Blvd.
Auburndale, FL
33823-3549
813/967-5746
\$20/yr.; NL, 9 SIGs, TS,
TE, SL, BBS

Manatee PC Users
c/o Dan Crumpler
411 67th St. NW
Bradenton, FL
34209-1652
813/792-3437
\$20/yr.; NL, 10 SIGs,
TS, TE, SL

Hernando/Citrus PC
Users Group
c/o Joseph Gatti
P.O. Box 1106
Brooksville, FL 34605
904/799-4094
\$10/yr.; NL, SL, BBS

Southwest Florida PC
Users Group
P.O. Box 1466
Fort Myers, FL 33902
813/997-0910
\$25/yr.; NL, 3 SIGs, SL

South Polk County PC
Users Group
c/o Bill Goddard
815 N. Lake Reedy Blvd.
Frostproof, FL 33843
813/635-3381
No fee; TE

HogTown Hackers
c/o Bruce Ruiz
4623 N.W. 13th Ave.
Gainesville, FL 32605
904/392-3151 (days)
\$15/yr.; TS, TE, SL, BBS

Miami PC User Group
c/o Jeffrey Feinberg
4651 Sheridan St.
#300
Hollywood, FL 33021
305/962-8889
\$24/yr.; NL, 4 SIGs, TS,
TE, SL, BBS

PC Users Group of
Jacksonville
P.O. Box 47197
Jacksonville, FL
32247-7197
904/737-6327
\$20/yr., \$10 initiation
fee; NL, 8 SIGs, TE, TS,
BBS

Ridge Area Computers
c/o Web Austin
251 Tower Lakes

Lake Wales, FL 33853
813/676-5936
\$20/yr.; NL, 3 SIGs, TS,
TE, SL

Central Florida
Computer Society
P.O. Box 948019
Maitland, FL 32751
407/332-2883
\$20/yr.; NL, 11 SIGs,
TS, SL

P.C.B.U.G.
P.O. Box 285
Naples, FL 33939
813/261-8208
\$10/yr.; NL, TS, TE, SL

Charlotte County PC
Users Group
P.O. Box 3530
Port Charlotte, FL
33949
813/624-3899
\$25/yr.; NL, SIG, TS,
TE, SL, BBS

Tri-County Computer
User Group, Inc.
P.O. Box 7414
Port St. Lucie, FL
34985-7414
407/878-7763
\$20/yr.; NL, 6 SIGs, TS,
TE, SL, BBS

EpSuncoast Users'
Group
c/o Dick Lee
1237 79 St. S
St. Petersburg, FL
33707
813/343-2668
\$15/yr.; NL, TS, SL

Sarasota IBM PC Users
c/o Barton Koslow
4557 Camino Real
Sarasota, FL 34231
813/924-4480
\$15/yr.; NL, 11 SIGs,
TS, TE, SL

Fort Lauderdale
Computer Users
c/o Steve Matus
8461 N.W. 31st Pl.
Sunrise, FL 33351
305/748-7237
\$24/yr.; NL, SL

University of South
Florida PC Users
University of South
Florida
SVC 4010
(continues)

There's only one word processor that's as easy to pick up as ours.



Forget everything you've heard about word processing software.

That the software takes too much time to learn. That they have all sorts of features you'll never use. That it's a lot easier to pick up a pen and start writing.

Professional Write® from Software Publishing Corporation can do everything from a simple memo to a complex report. Yet all you do to start using Professional Write is to turn it on. You don't need

to spend hours poring over manuals or sitting in classes. And, there are simple on-screen menus to take you from start to finish.

Professional Write wasn't just named for professionals, it was designed for professionals. No wonder it's the best-rated, best-selling executive word processing software.

What proof? Put down your pen and call.

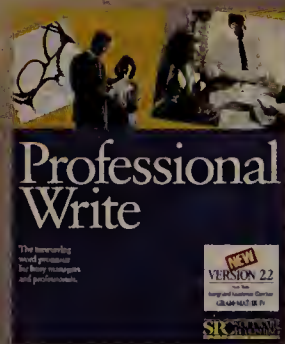

SPC SOFTWARE PUBLISHING CORPORATION

For a free Professional Write 2.2 trial disk, call 1-800-336-8360, Operator 580.

Runs on IBM PC and MS-DOS compatibles. Professional Write is a registered trademark of Software Publishing Corporation. ©1991 Software Publishing Corporation, 1901 Landings Dr., Mountain View, CA 94039-7210.

c/o U.C.S. Infocenter
Tampa, FL 33620-6940
813/974-3190
No fee; NL, 4 SIGs, TE,
BBS

Palm Beach PC Users
c/o Jack R. Cook
319 Sequoia Dr.
West Palm Beach, FL
33409
407/689-8841
\$20/yr.; NL, 6 SIGs, TS,
TE, SL, BBS

GEORGIA

Atlanta PC Users
P.O. Box 28788
Atlanta, GA 30358
404/255-0258
\$30/yr.; NL, 11 SIGs,
TS, SL, BBS

CSRA Computer Society,
Inc.
c/o Bob Kiernan
P.O. Box 284
Augusta, GA 30903
404/790-5241
No fee; TS, TE, SL, BBS

LaGrange Area Micro
Users Group
c/o Dan Jones
262 E. Lakeview Dr.
LaGrange, GA 30240
404/884-4563
\$20/yr.; NL, SL, BBS

IDAHO

Idaho PC Users Group
P.O. Box 9136
Boise, ID 83707
208/939-9120
\$25/yr.; NL, 4 SIGs, TS,
TE, SL, BBS

ILLINOIS

Northern Illinois
Computer Society
P.O. Box 547
Arlington Heights, IL
60006
708/824-2650
\$24/yr.; NL, SIG, SL,
BBS

Chicago Computer
Society
P.O. Box 8681
Chicago, IL
60680-8681
312/794-7737
\$40/yr.; NL, 17 SIGs,
TS, TE, BBS

Association of Personal
Computer Users
c/o Alan Berger
9063 N. Clifton Ave.
Niles, IL 60648

312/643-7280
\$45/yr.; NL, TE, SL, BBS

Fox Valley Computer
User Group
P.O. Box 28
North Aurora, IL 60542
708/879-6462
\$20/yr.; NL, 5 SIGs, TS,
TE, SL, BBS

Peoria Computer Club
P.O. Box 758
Peoria, IL 61602
309/685-8289
\$20/yr.; NL, SL

Western Illinois
Programmers and Users
Group
c/o Edward Mills
RR 5, Box 75
Quincy, IL 62301-9314
217/656-3671
\$20/yr.; NL, 3 SIGs, SL

Fox Valley Computer
Society
c/o Daniel J. Kairis
P.O. Box 188
South Elgin, IL 60177
708/359-5159 (Ken
Magin)
\$24/yr.; NL, SL

Northern Illinois
Computer Owners
c/o Keith Edison
N. 371 County Farm
Rd.
Winfield, IL 60190
708/653-3416
\$10/yr.; NL, SL, BBS

INDIANA

Anderson Computer
User Group
c/o Roy Winkler
830 Harold St.
Anderson, IN
46013-1628
317/646-3316 (days)
\$20/yr.; NL, 3 SIGs, TE,
SL, BBS

Indianapolis Computer
Society
P.O. Box 2532
Indianapolis, IN 46206
317/251-2003
\$25/yr.; NL, 9 SIGs, TS,
TE, SL, BBS

Michiana Amateur
Computer Society
P.O. Box 2171
Michigan City, IN
46360
219/872-1579

\$15/yr.; NL, 3 SIGs, TS,
TE, SL, BBS

IOWA

Quad-Cities Computer
Society
P.O. Box 2456
Davenport, IA
52809-2456
319/386-3484
\$20/yr.; NL, TS, TE, SL,
BBS

Hawkeye PC Users
P.O. Box 2592
Iowa City, IA 52244
319/351-7462
\$15/yr.; NL, 2 SIGs, TS,
TE, BBS

Northeast Iowa PC
Users
c/o Barbara Blow
320 Oak Park Cir.
Waterloo, IA 50701
319/234-0654
\$15/yr.; NL, TS, TE

KANSAS

Topeka PC Users Club
P.O. Box 1279
Topeka, KS 66601
913/266-4505
\$15/yr.; NL, 7 SIGs, TS,
TE, SL

KENTUCKY

Bluegrass IBM PC Users
Group
c/o Bob Cooke
1160-A Centre Pkwy.
Lexington, KY 40517
606/269-6902
\$15/yr.; NL, TS, SL, BBS

Central Kentucky
Computer Society
2050 Idle Hour Center
#160
Lexington, KY 40502
606/266-7446
\$20/yr.; NL, 8 SIGs, TS,
TE, SL, BBS

Kentucky-Indiana PC
Users Group
P.O. Box 3564
Louisville, KY 40201
502/560-2562
\$25/yr.; NL, 15 SIGs,
TE, SL, BBS

Heartland Users
c/o Tom Willoughby
155 Highland Cir.
Paducah, KY
42003-1206
502/898-2489
\$25/yr., \$25 initiation
fee; NL, SL, BBS

Powell County PC Users
Group
c/o Compserve Ltd.
P.O. Box 399
Stanton, KY
40380-0399
606/663-2472
\$10/yr.; NL, TS, TE

LOUISIANA

IBM Serious Users of
Baton Rouge
c/o Jay Brohn
Computer Electronics
1955 Dallas Dr.
Baton Rouge, LA
70806-1430
504/924-8066
No fee; NL, TS, TE, BBS

Acadiana
Microcomputer Users
P.O. Box 51142
Lafayette, LA 70505
318/235-6701
\$12/yr.; NL, 6 SIGs, TS,
TE, SL, BBS

Northwest Louisiana PC
User Group
c/o H. G. Friedman
945 Dudley Dr.
Shreveport, LA 71104
318/868-5950
\$25/yr.; NL, TE, SL

MAINE

Island/Reach Computer
Users
P.O. Box 1029
Blue Hill, ME 04614
207/374-5751
\$15/yr.; NL, TS, TE, SL

Downeast Computer
Society
P.O. Box 384
Deer Isle, ME 04627
207/367-5955
\$15/yr.; NL, 4 SIGs

Portland Maine IBM
User Group
c/o Louis De Angelis
26 Cascade Rd.
Old Orchard Beach, ME
04064
207/934-5521
No fee; TS, TE, BBS

MARYLAND

Chesapeake PC Users
2315B Forest Dr. #31
Annapolis, MD 21401
301/647-7139
\$24/yr.; NL, 4 SIGs, TS,
TE, BBS

Communal Computing
P.O. Box 6599

Silver Springs, MD
20916
301/598-9062
\$36/yr.; NL, 3 SIGs, TS,
TE, SL, BBS

MASSACHUSETTS

Boston Computer
Society (BCS)
One Kendall Square
Cambridge, MA 02139
617/252-0600
\$39/yr.; NL, 20 SIGs,
TS, TE, BBS

Pioneer Valley PC Users
P.O. Box H
North Amherst, MA
01059
413/549-4856
\$14/yr.; NL, 8 SIGs, TS,
TE, SL, BBS

MICHIGAN

Flint Area Computer
Enthusiasts (FACE)
P.O. Box 69
Flint, MI 48501
313/667-3183
\$10/yr., \$15 initiation
fee; NL, SIG, SL, BBS

Cursors IBM PC Users
c/o Karen Secor
Gogebic Community
College
E. 4946 Jackson Rd.
Ironwood, MI 49938
906/932-4231
\$6/yr.; NL, TS, TE

Southwestern Michigan
PC Users Group
c/o R. K. Schmitt
2320 Crosswind Dr.
Kalamazoo, MI 49008
616/349-5381
\$20/yr.; NL, 2 SIGs, TS

Midland Computer
Club
c/o Fred Stoll
830 W. Prairie Rd.
Midland, MI 48640
517/839-0022
\$15/yr.; NL, 3 SIGs, TS,
TE, SL, BBS

Detroit Area Network
User Group
Box 69015
Pleasant Ridge, MI
48069
313/646-9116
\$35/yr.; NL, TS, TE

Sterling Heights
Computer Club
P.O. Box 925
Sterling Heights, MI
(continues)

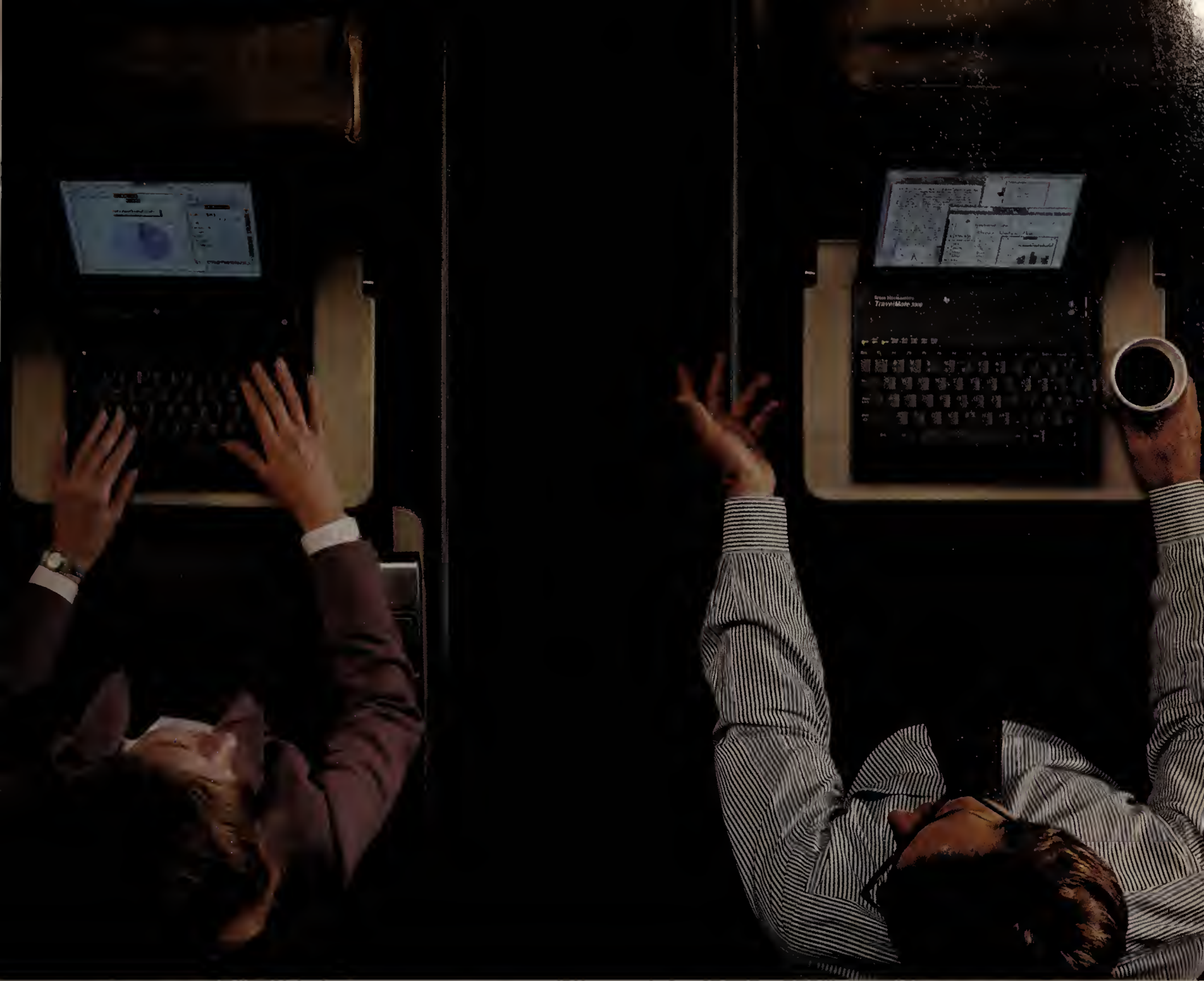

The TI TravelMates. They're making a hit coast to coast.



The new look of power.

Editors across the country are praising the performance, size and weight of the Texas Instruments TravelMate™ 2000 and 3000 notebook computers.



"The TravelMate is as close as you can get to the ultimate portable." — *BYTE*, November 1990.





"Now TI assumes the lead in performance/pound/price measure of a notebook." — *PC Magazine*, December 11, 1990.*

"Not until you hold this computer in your hands do you begin to understand what sets it apart from the pack."—



PC Computing, December 1990.**

Both TravelMate models are only 8½" x 11" in size, including a hard disk drive,  and feature a 10" diagonal  VGA display and comfortable full-function keyboard.

With the TM 2000 you get 286™ processing in a computer

that's 1.4" thin and 4.4 lbs. light. The TM 3000, meanwhile, packs 20MHz 386™ SX power into a mere 1.8" and 5.7 lbs.



Find out how to take the new look of power with you coast to coast. Or wherever your work takes you.

For the name of the dealer nearest you, call 1-800-527-3500.

**TEXAS
INSTRUMENTS**

TravelMate is a trademark of Texas Instruments Incorporated. 286 and 386 are trademarks of Intel Corporation. *Reprinted from *PC Magazine*, December 11, 1990. Copyright ©1990 Ziff Communications Company. **Reprinted from *PC Computing*, December 1990. Copyright ©1990 Ziff Communications Company. TravelMate has earned the following awards: 1990 *PC Magazine* Editor's Choice Award (October 16, 1990); 1990 *PC Magazine* Award for Technical Excellence; *BYTE* Award of Excellence; 1990 *PC World* Best Buy. TravelMate 3000 has earned the following awards: 1990 *PC Computing* Most Valuable Product; 1990 *BYTE* Award of Merit.

48311-0925
313/939-4154
\$20/yr.; NL, SL

MINNESOTA

Twin Cities PC Users
c/o Brian Cragoe
Edina Community
Center
5701 Normandale Rd.
Edina, MN 55424
612/888-0557
\$30/yr.; NL, 17 SIGs,
TS, TE, SL

MISSOURI

Kansas City IBM PC
User Group
c/o Bill Meeker
221 E. 63rd St.
Kansas City, MO 64113
816/444-8709
\$15/yr.; NL, 2 SIGs, TS,
TE, SL

Microcomputer Users
P.O. Box 411436
Kansas City, MO
64141-1436
816/587-8820
\$15/yr.; NL, TS, TE, SL,
BBS

St. Louis Users Group
P.O. Box 69099
St. Louis, MO 63169
314/458-9604
\$35/yr.; NL, 13 SIGs,
TE, SL, BBS

NEVADA

Las Vegas PC Users
c/o Lonnie Odom
5000 E. Bonanza Rd.
#8788
Las Vegas, NV 89110
702/431-4333
\$25/yr.; NL, 11 SIGs,
TS, TE, SL

NEW HAMPSHIRE

Pemi-Baker Computer
Group
c/o Henry D. Ahern, Jr.
RFD 2, Box 399
Plymouth, NH 03264
603/536-3880
\$12/yr.; NL, 3 SIGs, SL

NEW JERSEY

PC Club of South Jersey
P.O. Box 427
Cherry Hill, NJ 08003
609/428-8759
\$25/yr.; NL, TS, TE, SL,
BBS

Brookdale Computer
Users Group
c/o Ruth Lewart
12 Georjean Dr.
Holmdel, NJ 07733
908/264-9541
\$15/yr.; NL, TS, TE,
SL, BBS

South Jersey IBM PC
Users Group
P.O. Box 1117
Ocean City, NJ
08226-1117
609/399-4111
\$15/yr.; NL, 6 SIGs, TS,
TE, SL, BBS

New Jersey PC Users
P.O. Box 14
Paramus, NJ
07653-0014
201/447-7111
\$25/yr.; NL, 2 SIGs, SL

Amateur Computer
Group of New Jersey
P.O. Box 135
Scotch Plains, NJ 07076
908/574-1282
\$15/yr.; NL, 9 SIGs, TS,
TE, SL, BBS

Computer Connection
P.O. Box 382
Voorhees, NJ 08043
609/783-7444
No fee; TS, SL, BBS

NEW YORK

Long Island PC Users
c/o Roy Linker
659 Stratford Rd.
Baldwin, NY 11510
516/546-7857
\$18/yr.; NL, 12 SIGs,
TS, TE, SL, BBS

Buffalo IBM PC Users
P.O. Box 609
Buffalo, NY 14226
716/695-2593
\$30/yr.; NL, 18 SIGs,
TS, TE, SL, BBS

Long Island Computer
Association
P.O. Box 71
Hicksville, NY 11802
516/293-8368
\$25/yr.; NL, 22 SIGs,
TS, TE, BBS

Hudson Valley PC Club
Box 6057
Kingston, NY 12401
914/657-6354

\$20/yr.; NL, 3 SIGs, TS,
SL

Computer Club of
Rockland
c/o H. Stanley Smith
9 Chestnut Grove Ct.
New City, NY
10956-2713
914/634-6618
\$20/yr.; NL, 5 SIGs, TS,
TE, SL

Creative Computing
c/o Douglas Margolis
153 E. 57 St. #8G
New York, NY 10022
212/888-3953
\$15/yr.; NL, TS, SL

New York Amateur
Computer Club
P.O. Box 3442
Church Street Station
New York, NY 10008
212/505-6021
\$20/yr.; NL, 7 SIGs, SL,
BBS

New York Personal
Computer Group
(continues)

How would you rather hunt for an image?

Scrapbook+™ for Microsoft® Windows™ lets you see the images you've stored, so you don't have to guess your way through long lists of cryptic filenames to find what you need. You can store hundreds of images with multiple formats in a single Scrapbook+ file... view them in seconds as thumbnails or full size... and then quickly place them into your documents. Don't waste another minute playing hide-and-peek with your images. Call 800/727-2793 for your local dealer.



© 1990 Eikon Systems, Inc., 989 E. Hillsdale Blvd., Suite 260, Foster City, CA 94404

The old way.

The Scrapbook+ way.

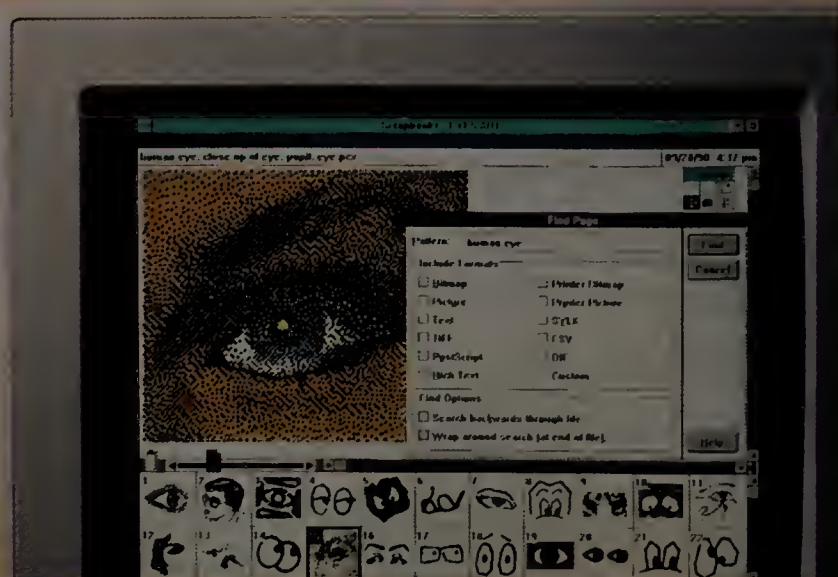
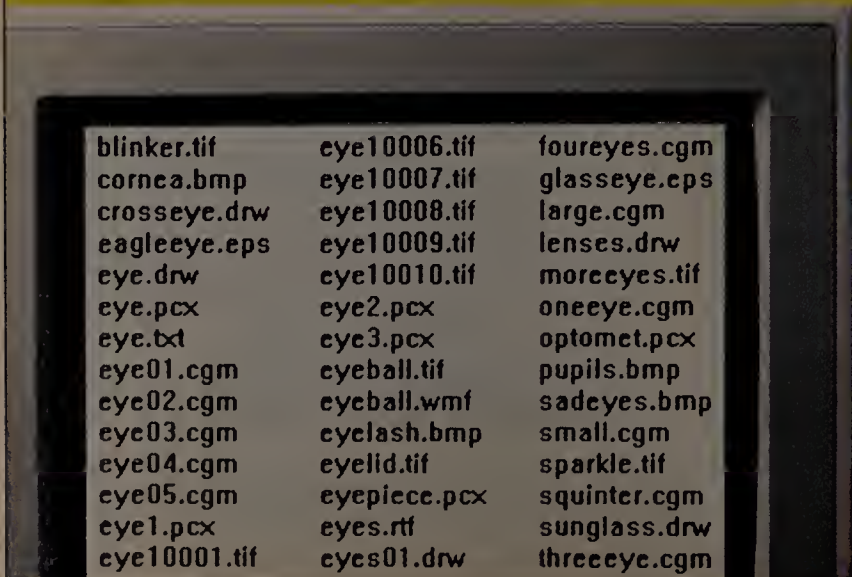

Circle 82 on reader service card

23 Symbol Libraries for under \$50.00 each
Call 1-800-223-2521 for details

Now Available

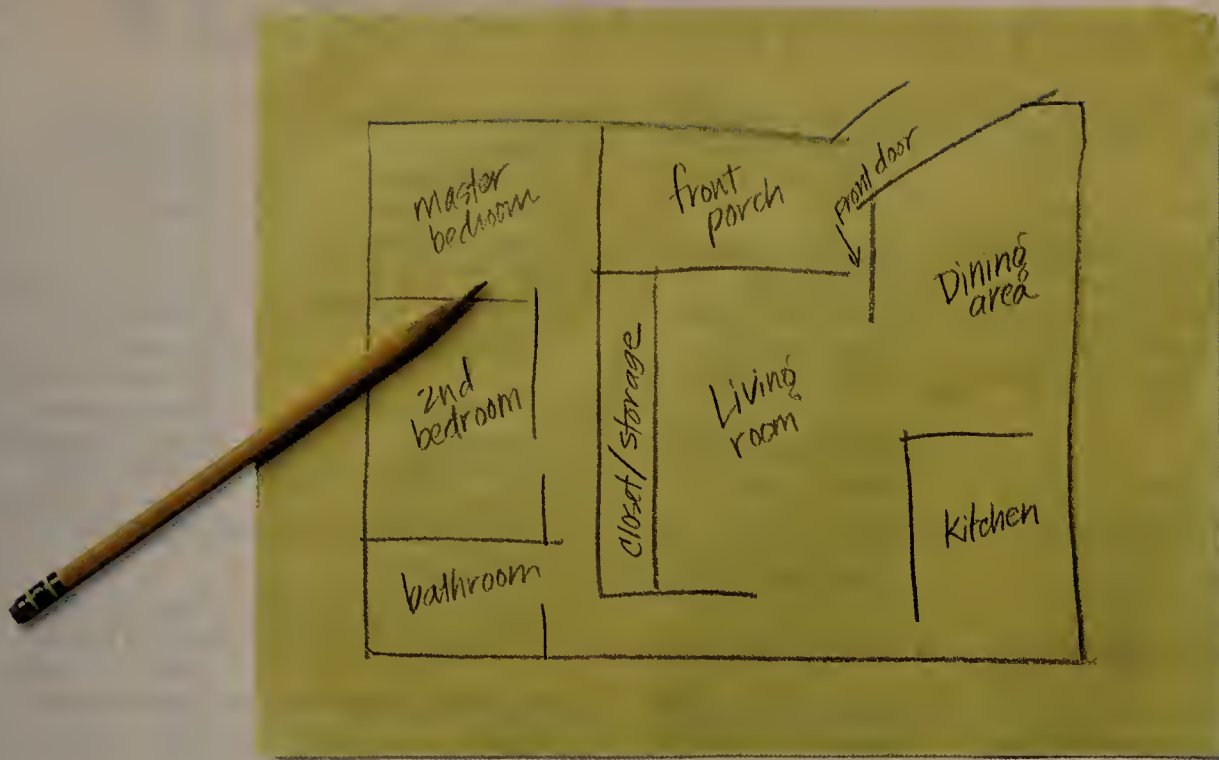

Sketch.

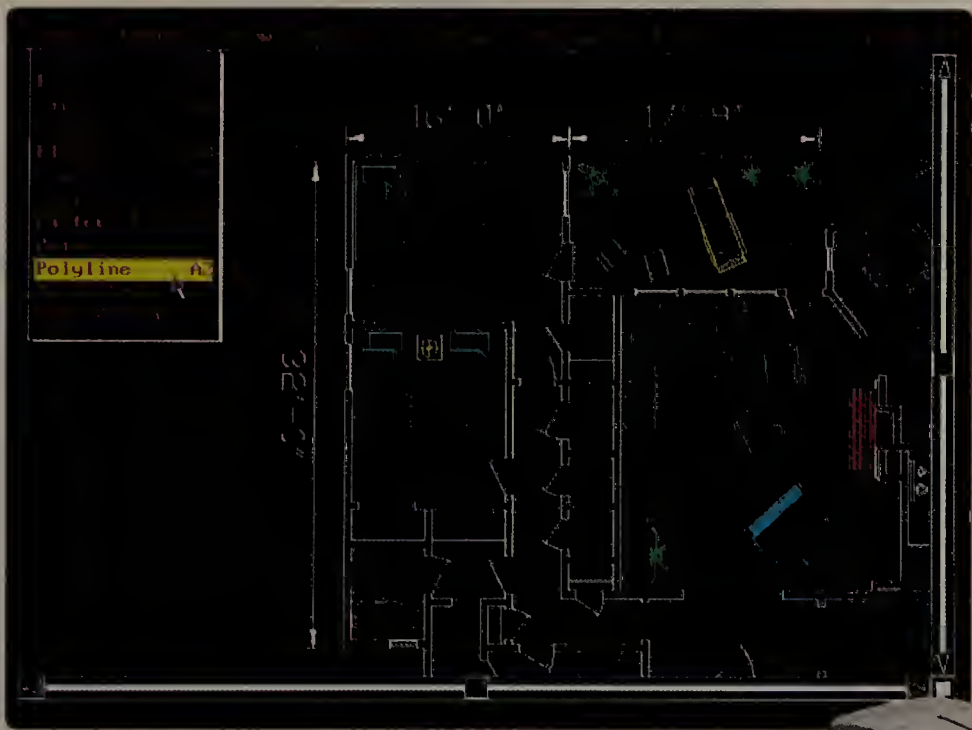

AutoSketch®

If you can sketch, you can AutoSketch. Which gives you real CAD power — speed, accuracy and easy revisions — all without a long, drawn-out learning curve.

With AutoSketch Version 3, you have our easiest CAD yet with pull-down menus and on-screen icons. You also have DXF™

U.S. \$249



file compatibility and associative dimensioning. It's what you'd expect from the makers of AutoCAD®, the world's most popular CAD package.

Go ahead. Give it a try — demo version available for just \$9.95. Call us at 1-800-223-2521 for more information.

We'll sketch in the details.

 **AUTODESK**

40 Woll St. #2124
New York, NY
10005-1301
212/686-6972
\$35/yr.; NL, 53 SIGs,
TS, TE, SL

Leatherstocking
Computer Users' Club
P.O. Box 1284
Oneonta, NY
13820-5284
607/432-3811
\$15/yr.; NL, 3 SIGs, TE,
SL, BBS

Long Island Computer
Society
P.O. Box 2440
Potchogue, NY 11772
516/475-3480
\$25/yr.; NL, 7 SIGs, SL,
TS

FROG Computer
Society
c/o Jim McCollum
321 Executive Office
Bldg.
Rochester, NY
14614-1701

716/244-4038
\$25/yr.; NL, 4 SIGs, TS,
SL

PC Rocklond Users
32 Smith Ave.
South Nyack, NY 10960
914/358-8145
No fee; 6 SIGs, TS, TE,
SL, BBS

Syracuse
Microcomputer Club
P.O. Box 753
Syracuse, NY
13205-0753
315/492-6437
\$20/yr.; NL, SL, BBS

Westchester PC Users
P.O. Box 349
White Plains, NY
10602-0349
914/923-1337
\$25/yr.; NL, 2 SIGs, TS,
TE, SL, BBS

NORTH CAROLINA
IBM PC Users Group of
Asheville
c/o Doug French
44 Hollybrook Dr.

Asheville, NC 28803
704/274-5331
\$15/yr.; SL

Foothills PC Users
P.O. Box 563
Hickory, NC 28603
704/256-6924
\$25/yr.; NL, TE, SL, BBS

NORTH DAKOTA
Magic City IBM PC
Users Group
P.O. Box 3124
Minot, ND 58702-3124
701/839-6008
\$10/yr.; NL, SL

Wahpeton IBM PC
Users
P.O. Box 181
Wahpeton, ND 58074
701/642-4920
\$12/yr.; NL, SIG

OHIO
Cincinnati Personal
Computer Users
P.O. Box 3097
Cincinnati, OH 45201
513/745-9356
\$20/yr.; NL, 6 SIGs, TS,
TE, SL, BBS

Cleveland Computer
Society
c/o Dan Honson
3150 Poyne Ave.
Cleveland, OH 44114
216/781-4132
\$25/yr.; NL, 30 SIGs,
TS, TE, SL, BBS

Northeast Ohio PC
Users Group
P.O. Box 81281
Cleveland, OH
44181-0281
216/433-4387
\$20/yr.; NL, 15 SIGs,
TS, TE, SL, BBS

Columbus Computer
Society
P.O. Box 1556
Columbus, OH 43216
\$25/yr.; NL, 23 SIGs,
TS, TE, SL, BBS

Dayton Microcomputer
Assoc., Inc.
c/o Bob Kwoter
Dayton Museum of
Natural History
2629 Ridge Ave.
Dayton, OH

45414-5499
513/252-1230
\$12/yr.; NL, TS, TE,
SL, BBS

MS-DOS PC Users
c/o Dr. Rolph R.
Gurowski
200 Roubush Hall
Miami University
Oxford, OH 45056
513/529-4228
No fee; NL, 3 SIGs, TS,
TE, SL

Toledo PC Users
P.O. Box 13085
Toledo, OH 43613
419/471-9444
\$20/yr.; NL, 27 SIGs,
TS, TE, SL, BBS

Western Reserve IBM PC
Association
P.O. Box 8828
Warren, OH 44484
216/373-2745
\$15/yr.; NL, TS, TE, SL

OKLAHOMA
OKC PC Users Group
P.O. Box 12027
(continues)

Give Us Your Toughest Peripheral Sharing Problem

...or your simplest! Master Switch, the intelligent data switch from Rose Electronics, can handle it. The Master Switch series is so versatile and sophisticated, peripheral sharing becomes easy.

Anyone who appreciates ease-of-operation and technologically-advanced capabilities knows the Master Switch is the right choice...for sharing printers, plotters, modems, and any device with a serial or parallel port. Here's why:

- Any combination of serial or parallel ports
- Easy selection of peripherals
- User-expandable memory up to 4 megabytes
- Simultaneous access to all devices
- Rated 'fastest switch' by PC Magazine
- Advanced features include job queue, port contention, data collection, job control menu, initialization strings, pop-up menus, and many more
- Complete technical support; one-year warranty

The Low-Cost LAN Alternative
With our MasterNet software, the Master Switch provides many convenient LAN functions, such as E-mail, file transfer, and directory access.

Designed and manufactured in the USA. Field-proven in thousands of applications. The Master Switch answers any peripheral sharing challenge. Choose the intelligent data switch that handles your most complex needs, yet is easy to set up and operate... choose Master Switch.



(800) 333-9343

FAX (713) 933-0044 • (713) 933-7673
P.O. Box 742571 • Houston, Texas 77274
Call for complete information and our catalog of Switching and Sharing Solutions. Dealer inquiries welcome.

Yes Send me a **FREE** demo disk of **Personal R:BASE.**

Size: 3.5" 5.25"

Name: _____

Title: _____

Company: _____

Address: _____

City: _____ State: _____ Zip: _____

Daytime Phone: _____

Are you interested in Personal R:BASE for your:

Home Office

What do you anticipate using Personal R:BASE for?

How many PCs are there in your office? _____

Do you have experience with any other database products:

No Yes Which Products? _____

What type of hardware do you anticipate running Personal R:BASE on?

XT 286 386 Laptop

NOTE: You must complete all questions to receive the free demo disk. Allow 30 days for delivery.



NO POSTAGE
NECESSARY
IF MAILED
IN THE
UNITED STATES

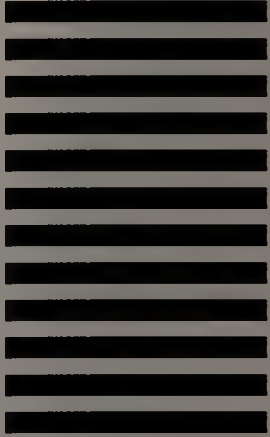

BUSINESS REPLY MAIL
FIRST CLASS MAIL PERMIT NO. 220 BELLEVUE, WA

POSTAGE WILL BE PAID BY ADDRESSEE

MICRORIM[®]

ATTN: CUSTOMER SERVICE
15395 S.E. 30TH PLACE
BELLEVUE, WA 98007-9918



SAVE THE MONEY AND RUN

PERSONAL R:BASE™ SIMPLICITY AND RELATIONAL DATABASE POWER FOR ONLY \$99.

Personal R:BASE gives you more features and faster results than any other stand-alone PC database.

Simply put, it's the best value on the market today.

Priced at just \$99 for a limited time, Personal R:BASE is the only database delivering both relational power *and* ease of use. That means greater productivity.

Easy-to-learn, easy-to-use cascading menus actually guide you through operation, prompting your every move. You also get a comprehensive on-line tutorial and free telephone support.

Relational power is another key to data management productivity. With Personal R:BASE you can immediately create your own special applications and screens—all without programming. You'll also find five free, ready-to-run applications to manage everything from your home finances to mailing lists.

Plus you can read and write dBASE III™ and III+™ files, as well as import spreadsheets and text data.



The greatest value for your money. That's what you get from Personal R:BASE. And it's all backed by Microrim, the developer of R:BASE 3.1, with over 650,000 satisfied users.

Relational power and simplicity, with a \$99 price and money-back guarantee. It's easy to see why Personal R:BASE is the runaway success.

With our easy, pull-down menus, you'll quickly query, sort, report and manage your data—no programming or commands are required.

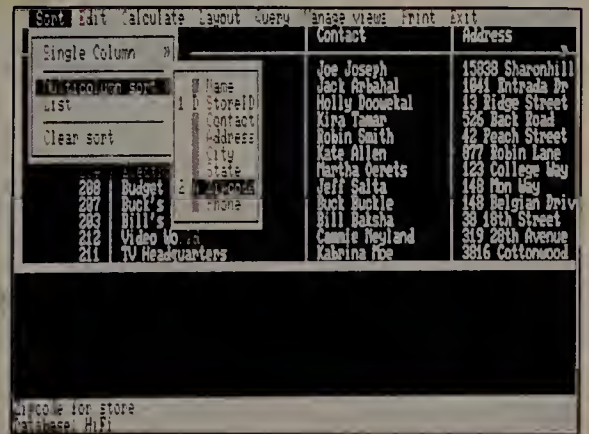

See your local dealer or:

ORDER NOW
800-248-2001

Ask for operator #31 7 am to 5 pm Pacific Time

MICRORIM®

*March 1991: Full product discounted selling price
Product names are trademarks of their respective companies.

PC Database Features	Personal R:BASE	Paradox	Q&A
Easy-to-use, pull-down menus	✓		
QBE: Query by Example	✓	✓	
Relational: supports connection of multiple data files	✓	✓	
Quick input form generator	✓		✓
Full on-line tutorial	✓		✓
Directly reads and writes dBASE III and III+ files	✓		
Imports and exports spreadsheet data	✓	✓	✓
Free applications included	✓		
Typical selling price*	\$99	\$470	\$250

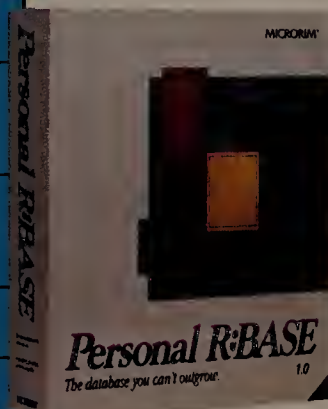

Oklahoma City, OK
73157-2027
405/791-0894
\$25/yr.; NL, 12 SIGs,
TS, TE, SL, BBS

Tulsa Computer Society
Box 3211
Tulsa, OK 74101
918/622-3417
\$10/yr.; NL, 6 SIGs, TS,
TE, SL, BBS

OREGON
Eugene PC Users
P.O. Box 11436
Eugene, OR 97440
503/484-3306
\$25/yr.; NL, 3 SIGs, TS,
SL, BBS

Race Computer Club
c/o Robert Viehweg
1358 Willow Ct.
Grants Pass, OR 97527
503/479-8629
\$7.50/yr.; NL, TS, SL

Portland PC Users
921 S.W. Morrison
Galleria #529

Portland, OR 97205
503/226-4143
\$30/yr.; NL, 12 SIGs,
TS, TE, SL, BBS

PENNSYLVANIA
Computer Users of Erie
P.O. Box 1975
Erie, PA 16507-0975
814/454-1658
\$25/yr.; NL, 3 SIGs, TS,
TE, SL, BBS

Exton PC Council, Inc.
Chester County Library
400 Exton Square Pkwy.
Exton, PA 19341
215/363-0884
\$15/yr.; NL, 6 SIGs, SL,
BBS

Harrisburg PC Users
c/o Jack Stahl
1195 Fairmont Dr.
Harrisburg, PA 17112
717/652-9097
\$15/yr.; NL, TS, SL, BBS

Philadelphia Area
Computer Society
c/o Steve Longo
La Salle University

1900 W. Olney Ave.,
Box 312
Philadelphia, PA 19141
215/951-1255
\$27 first year, \$25/yr.
thereafter; NL, 70 SIGs,
TS, TE, SL, BBS

Greene County PC
Users Group
42 S. West St.
Waynesburg, PA
15370-2030
412/852-1494
\$10/yr.; NL, 3 SIGs, TS,
SL, BBS

RHODE ISLAND
South County Computer
Users
P.O. Box 493
Wakefield, RI 02880
401/539-6034
\$10/yr.; NL, SL, BBS

SOUTH CAROLINA
Charleston Computer
Club
P.O. Box 520
Charleston, SC
29402-0520

803/722-7445
\$19/yr.; NL, 4 SIGs, TS,
TE, SL, BBS

Palmetto Personal
Computer Club, Inc.
P.O. Box 2046
Columbia, SC 29202
803/754-7525
\$25/yr.; NL, 5 SIGs, TS,
TE, SL, BBS

TENNESSEE
Cumberland
Microcomputer Users
P.O. Box 151
Cookeville, TN 38503
615/372-3982
\$20/yr.; NL, TS, SL, BBS

Music City IBM PC Users
Group
c/o Alan Ashendorf
488 Saddle Dr.
Nashville, TN 37221
615/662-0322
\$35/yr.; NL, 12 SIGs,
TS, TE, SL, BBS

East Tennessee PC
Users Group
c/o Steve Peyrot

1345 Oak Ridge Tpke.
#291
Oak Ridge, TN 37830
615/435-3311 (days)
\$20/yr.; NL, 4 SIGs, TS,
TE, SL, BBS

TEXAS
Golden Triangle PC
Club
P.O. Box 20905
Beaumont, TX
77720-0905
409/898-4598
\$12/yr.; NL, TS, TE, SL,
BBS

Brazos Valley PC
c/o Charles Ellis
1920 Peach Creek Rd.
College Station, TX
77845
409/779-5050 ext. 238
\$6/yr.; NL, TS, TE, SL

North Texas PC Users
P.O. Box 780066
Dallas, TX 75378-0066
214/746-4699
(continues)

Introducing...Incredible

Windows™ Accounting Software!

Introducing M.Y.O.B. for Windows... After years of success on the Macintosh, M.Y.O.B. is now available for Windows, with the same great features, exceptional graphics, and point and click control.

M.Y.O.B. for Windows is a powerful, fully-integrated accounting program! With just a few clicks, you can control every facet of your business...print your financial reports, reconcile your checkbook, update receivables, reorder inventory, print mailing labels, even call your customers — all with M.Y.O.B.

M.Y.O.B. Is Fast — Built for speed...you can do almost everything in a single step. Record a check in under 10 seconds. Save it as a recurring check, and record it in under 5 seconds!

M.Y.O.B. eliminates time-consuming accounting chores such as "posting" to the general ledger. Every section — general ledger, checkbook, receivables, payables and inventory — is seamlessly integrated.

M.Y.O.B. Is Easy — Using intuitive graphics makes it easy to understand and easy to use!

"There are several features which make the program easy to set up, easy to learn and easy to use." — MacWeek March, 1990

Checks look like real checks, invoices look like real invoices. And M.Y.O.B.'s unique command center window shows every function in clear, on-screen flow charts. No need to learn obscure commands — just point and click.

M.Y.O.B. Is Simple — With most DOS accounting programs, once an entry is made, it's lost in a tangle of debits and credits. With M.Y.O.B., you can see entries in their original form with just a click of the mouse. Click in the sales journal to see the original invoice; click in the disbursements journal to see the original check.

"Using M.Y.O.B. is simple and direct." — Macworld May, 1990

Change anything entered in the current session, automatically reverse entries made in prior sessions.

M.Y.O.B. Is Customizable — Design your own invoices, statements, purchase orders, checks and mailing labels. M.Y.O.B. includes an integrated drawing program that lets you add text fields, draw lines and boxes, move and resize fields, and paste graphics. Use your own forms! Don't get locked into using software vendor's forms.

Critical Acclaim — Since being released in 1989, M.Y.O.B. for the Macintosh has become the most acclaimed small-business accounting program.

"In the last two years, M.Y.O.B. has received two Eddy-award nominations. As accounting programs go, it packs more punch per dollar than almost any other system on the market. What makes the program different is that it combines the functionality experienced accountants expect with the ease of use novices demand. M.Y.O.B. is a solid, double-entry accounting system that can work in any small business." — MacUser April, 1991

(Trademark of Microsoft Corp.)

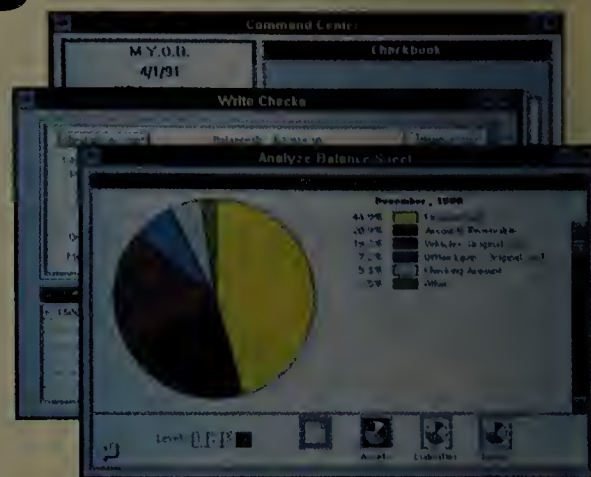

- General Ledger ■ Checkbook ■ Card File
- Accounts Receivable ■ Accounts Payable
- Inventory ■ Administration

Fully-functional **\$500!**
Demo Disk: \$5 LIMITED OFFER

CALL TODAY! 1-800-322-MYOB

NOW AVAILABLE AT YOUR SOFTWARE DEALER!

TELEWARE

300 Roundhill Drive • Rockaway, NJ 07866

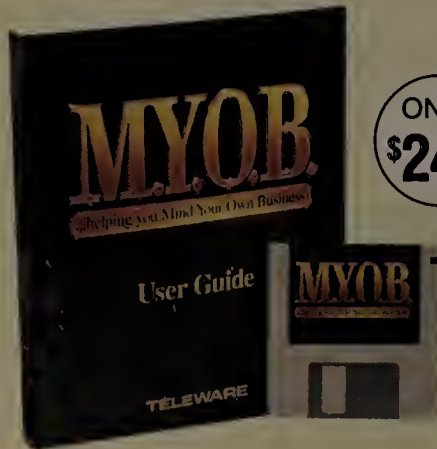

ONLY
\$249

Circle 278 on reader service card



ChipUp™ Technology



The AcerPower 486SX.
The World's 1st
Single CPU Chip
Upgradable System.

Introducing the world's first single CPU chip upgradable system, the AcerPower 486SX. Running at 20 MHz, the new AcerPower 486SX gives you the easiest, most cost-effective way to step up to increased 486 functionality. Utilizing Acer's **ChipUp™** technology*, all you have to do is plug in a new CPU and upgrade to full 33 MHz 486 functionality, practically doubling system performance. When you're ready to change, just plug in a chip. No more expensive boards to replace.

The AcerPower 486SX also offers a future upgrade path of up to 98 MB of system memory.



Together with integrated Ultra-VGA graphics, it furnishes a powerful graphics engine for Windows 3.0, desktop publishing, CAD/CAE, and other graphically demanding software applications. And with 15 built-in security features, desktop computing has never been more secure.

To see just how affordable Acer's upgradable 486SX technology can be, check out the new AcerPower 486SX. To see yours, just call one of the numbers listed below.

From notebooks to networks, Acer has it all.

Acer is a registered trademark of Acer Incorporated and Acer America Corp. Intel is a registered trademark of Intel Corp. Other products, brandnames, or companies mentioned are trademarks of their respective companies.

* Patent pending.

Acer America Corporation 401 Charcot Avenue, San Jose, CA 95131.
Call 1-800-SEE-ACER for More information.

Acer 

Your Global Partner in Computing

People are always looking for affordable ways to make a better impression.



Soon a lot more people will be looking their best. Because now the best features of the HP LaserJet III printer are more affordable.

The new LaserJet IIIP printer features HP's exclusive Resolution Enhancement technology. An innovation that provides 300 dpi print quality superior to that of ordinary laser printers. The PCL5 printer language, with font scaling and HP-GL/2, brings even more to your documents.

Fourteen bit-mapped and eight internal scalable typefaces give you thousands of options. And, to make things even more interesting, the LaserJet IIIP produces patterns, shading, spirals, and mirror images. In portrait or landscape.

HP has picked up the throughput speed of this 4 ppm printer. Due to a considerably faster I/O rate, the LaserJet IIIP accepts data as quickly as your PC can transfer it. So you not

only get your output faster, you get your screen back faster. The LaserJet IIIP also has a new 16 MHz processor and PCL5 for on-the-fly typeface scaling and fast vector graphics. These advancements mean this compact printer

Call 1-800-752-0900, Ext. 2255 for your nearest authorized HP dealer.
 Adobe and PostScript are registered trademarks of Adobe Systems Inc. in the U.S. and other countries.
 * Suggested U.S. list price. © 1991 Hewlett-Packard Company PE 12109

IDEAFOCUS

A whole new market

1990 was a record year for the American Bank Company, mostly due to the dramatic sales of our laser bank forms. Living Science. The technology, which introduced a new design, no-ink, no-eraser, and no-carriage, are the first to bank forms to be carried by major bank retailers. The demand for this service has been overwhelming. 1991, however, is a continuation of what we had in 1990. In fact, we had a record year for our laser bank forms. The demand for this service has been overwhelming. 1991, however, is a continuation of what we had in 1990. In fact, we had a record year for our laser bank forms.

Quarterly Analysis
 Comparison of Growth to Date
 Actual Growth
 Projections

Quarter	Actual Growth	Projections
1st Quarter	100%	100%
2nd Quarter	150%	150%
3rd Quarter	200%	200%
4th Quarter	250%	250%

Well measured expansion

1990 was a record year for the American Bank Company, mostly due to the dramatic sales of our laser bank forms. Living Science. The technology, which introduced a new design, no-ink, no-eraser, and no-carriage, are the first to bank forms to be carried by major bank retailers. The demand for this service has been overwhelming. 1991, however, is a continuation of what we had in 1990. In fact, we had a record year for our laser bank forms.

Results of careful planning

During the early 1980's, when the American Bank Company was a small, single player in the nationwide business market, a significant milestone was achieved when we introduced a new product to the market. This was the first time that we had a record year for our laser bank forms. The demand for this service has been overwhelming. 1991, however, is a continuation of what we had in 1990. In fact, we had a record year for our laser bank forms.

While other companies are focused on the traditional business market, we have expanded our focus to include the consumer market. This has allowed us to reach a much larger audience and has resulted in significant growth. We are confident that this strategy will continue to drive our success in the years ahead.

Tell them about the new LaserJet IIP.

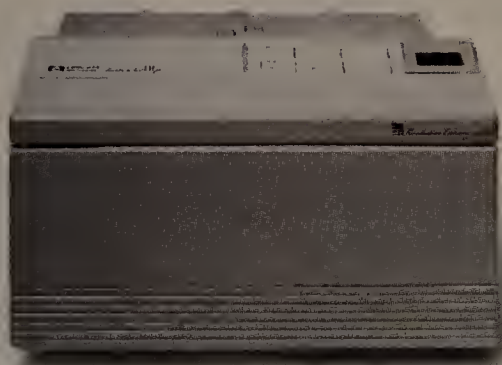

requires less time to print than many laser printers with higher ppm rates.

For versatility, the LaserJet IIP has a multisized paper tray that accepts various sizes of paper and envelopes. An optional Adobe® PostScript® cartridge is available. And, of course, the LaserJet IIP is compatible with all major software and HP LaserJet accessories.

The good looks you get with the newest HP LaserJet look

even better when you consider the price. Just \$1,595.* For a faxed data sheet, dial (208) 344-4809 from your FAX machine and enter document I.D. number 9600. Now everyone can add a little polish to their work.

HP Peripherals
When it's important to you.



**HEWLETT
PACKARD**

\$24/yr.; NL, 34 SIGs,
TS, TE, SL, BBS
Fort Worth IBM PC
Users Group
P.O. Box 1476
Fort Worth, TX
76101-1476
817/656-0446
\$24/yr.; NL, 4 SIGs, TS,
TE, SL

Bay Area PC
Organization
P.O. Box 580356
Houston, TX 77058
713/483-4807
\$25/yr.; TS, TE, SL, BBS

Houston Area League
PC Users, Inc.
1200 Post Oak Blvd.
#106
Houston, TX 77056
713/623-4425
\$25/yr.; NL, 45 SIGs,
TS, TE, SL, BBS

Mid-Cities PC Users
P.O. Box 54141
Hurst, TX 76054
817/457-7131
\$20/yr.; NL, 2 SIGs, SL,
BBS

Dallas-Fort Worth Users
Group
309 Lincolnshire
Irving, TX 75061
214/986-9228
\$30/yr.; NL, 4 SIGs, TS,
TE, BBS

Fort Bend Computer
Users Group
P.O. Box 292
Richmond, TX 77469
713/341-0220
\$25/yr.; NL, 10 SIGs,
TS, TE

Alamo PC
Organization, Inc.
P.O. Box 65180
San Antonio, TX
78265-5180
512/655-1058
\$25/yr.; NL, 11 SIGs,
TS, SL, BBS

Temple Area PC Club
c/o Jim Sylvester
1501 E. Barton St.
Temple, TX 76501
817/778-8575
\$15/yr.; NL, SL, BBS

Tyler Computer Club
c/o Marionetta Smith
4928 Richmond Rd.
Tyler, TX 75703
903/561-6136
\$20/yr., \$10 initiation
fee; NL, 4 SIGs, TE, BBS

UTAH
Utah Blue Chips
P.O. Box 510811
Salt Lake City, UT 84151
801/521-7830
\$15/yr.; NL, 8 SIGs, TS,
TE, SL, BBS

WASHINGTON
Pacific Northwest IBM
PC Users Group
P.O. Box 3363
Bellevue, WA 98009
206/646-6570
\$35/yr.; NL, 35 SIGs,
TS, TE, SL, BBS

Borderline PC Users
c/o Frank Miyazaki
1232 Grant St.
Bellingham, WA 98225
206/671-9113
\$12/yr.; NL, 2 SIGs, SL

Adak Computer Users
Box 5229
FPO Seattle, WA
98791-5229
\$10 initiation fee; NL, 4
SIGs, TE, SL, BBS

WEST VIRGINIA
Huntington PC Users
P.O. Box 2173
Huntington, WV
25722-2173
304/529-2391
\$15/yr.; NL, 10 SIGs,
TS, TE, BBS

Boot Hills PC Users
P.O. Box 686
Wheeling, WV 26003
304/845-1871
\$25/yr.; NL, SIG,
TE, SL

WISCONSIN
Fox Valley Technical
College PC Users
Group
P.O. Box 2277, Mail
Room 318

Appleton, WI
54913-2277
414/735-2414
\$12/yr., \$15 initiation
fee; NL, 8 SIGs, TS, SL,
BBS

LaCrosse PC Users
P. O. Box 2991
LaCrosse, WI 54602
608/782-1860
\$15/yr.; NL, 3 SIGs, TS,
TE, SL, BBS

Madison IBM PC Users
Group
P.O. Box 2598
Madison, WI
53701-2598
608/255-1205
\$30/yr.; NL, 7 SIGs, TE,
SL, BBS

Milwaukee Area IBM PC
Users Group
P.O. Box 2121
Milwaukee, WI
53201-2121
414/679-9075
\$15/yr.; NL, 6 SIGs, TS,
TE, SL, BBS ☉

PREVENT COMPUTER THEFT!

Kablit™ Security System



- Standard **Kablit** fasteners attach to equipment using existing screws. When cable passes through fasteners screws are concealed.
- Internal component security: **Kablit** fasteners secure rear panel of CPU preventing unauthorized removal of internal boards and hard drives.
- Now available: new **Kablit** glue-on fastener to secure equipment that does not have existing screws.

Kablit works with:

- | | | | |
|---------------|------------------|---------------|-----------------|
| • Computers | • Monitors | • Laptops | • Fax Machines |
| • Printers | • Keyboards | • Typewriters | • Copy Machines |
| • Disk Drives | • Laser Printers | • VCR's | • Audio Visual |

Prices \$34.95* to \$49.95* depending on system. Quantity pricing available. Money back if returned in 30 days. Purchase orders accepted. Send for catalog. *plus shipping

Secure-It, Inc. 18 Maple Court • E Longmeadow, MA 01028

1-800-451-7592, 1-413-525-7039 Dealer's Inquiries Invited.

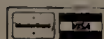

Circle 31 on reader service card

Fast,
aggressive,
cheap,
tireless,
impartial,
intelligent,
decisive &
tenacious!

EXPERT FOR HIRE

KnowledgeSEEKER®— the
brainy and tireless
information
analyst, will help
you make sense of
your mountains of
Lotus®, dBase®, or
ASCII data. Use its
statistical know-how to
find significant facts, figures

**JUST
\$495**

and trends that will help
you make better
decisions — faster
than ever before!
Buying this PC
software package
will be the last
decision you'll ever
have to make on your own.

Knowledge
SEEKER®

TURNING DATA INTO KNOWLEDGE

1-800-387-7335

1-613-723-8020 Fax 1-613-723-8048
FirstMark Technologies Ltd.
600-14 Concourse Gate
Ottawa, Ontario K2E 7S8

DECIDE NOW! CALL FOR MORE INFO

Circle 72 on reader service card

THE WORLDWIDE LEADER IN DATA PROTECTION OFFERS THESE THREE EXCITING PRODUCTS



ICELOCK

IceLock is an exclusive software protection device which allows any software reseller—from developers to distributors to corporate users—to protect the programs they sell or use from software piracy. IceLock is a small "dongle" which plugs into any serial or parallel port on the computer—and yet still leaves the port open for peripherals. Software can be used like a book: copies of programs can be kept in many places but only run on computers that have the exclusive ICE device. IceLock encodes existing EXE and COM files.



POWERWATCH

PowerWatch works with any UPS to provide guaranteed software and hardware shutdown during a power failure before the UPS batteries are exhausted. This eliminates the possibility of UPS failure when battery time is exceeded. It saves your files, exits your programs and logs out of the network. Available to MS-DOS, XENIX and UNIX users. Compatible with all major networks.



FILELOCK

FileLock is a combination of hardware and software to protect sensitive data. FileLock inserts into any serial or parallel port to allow secured data to be accessed from within an application. FileLock maintains a library of secure files and it compresses secured files.



TRACKER™ FIVE

personal contact management software

Tracker™ Five is an "intelligent" cardfile system which dramatically simplifies the storage, retrieval, up-dating and access of information on clients, customers, and contacts.

And, because *Tracker™ Five* can be a TSR (terminate and stay resident) system, it means that no matter what else you're working on, one hot-key brings *Tracker™ Five* to the screen, ready to help you write a note, schedule an appointment in your calendar, or retrieve a vital piece of information in an instant.

Distributorships available, call or fax:

313 R/E Lid. 43 Argow Pl. Nanuet N.Y. 10954 Tel. 1 (800) UD 313 RE
Tel. 1-(914) 623-1630. Fax (914) 623-7180

WORLDWIDE SUPPORT

Australia: (03) 8204920 Fax (03) 8203213

Belgium: (013) 771902 Fax (013) 777372

Denmark: (042) 804200 Fax (042) 804131

Italy: (02) 6698 1094 Fax (02) 6700 705

Malaysia: (03) 719 8299 Fax (03) 717 6558

Circle 309 on reader service card

THE MOST USEFUL TO COME ALONG



A few months ago we brought you the world's most useful computer—the Toshiba T2000SX.

That computer symbolized what we call “the next generation in personal computing.” A com-

puter that not only allows you the freedom to work where, when, and how you want to. But is so precisely engineered—from its superior keyboard to its easy-to-read VGA screen—

that you'll actually enjoy using it.

Well, thanks to the incredible speed of modern technology, here we are once again.

This time to present the new Toshiba T2000SXe.

MOST USEFUL COMPUTER SINCE FEBRUARY.

THE E STANDS FOR EXTRA POWER.

Like the T2000SX, the T2000SXe weighs a minuscule 6.9 pounds, it boasts a 386SX processor, and it supplies up to 60 MB of hard disk storage space. But, and here's the news, the T2000SXe gives you a bigger dose of speed (20MHz) and more memory (2-10 MB RAM).

Of course, the T2000SXe also offers Hypertext, a VGA screen, full modem capabilities (including available cellular and fax accessories), full-size sculpted keys on its keyboard and a host of additional benefits that make other notebooks look more like memo pads.

A LONGER LASTING BATTERY.

The most useful computer isn't of much use if its battery doesn't last long.

That's why the T2000SXe, like the T2000SX, is armed with a Nickel Hydride battery. Nickel Hydride is proven to deliver 22% more power per ounce than the NiCad batteries found in other portable computers. In fact, according to Byte magazine, the battery on Toshiba's T2000SX lasted well over three hours on a 90-minute charge. Outlasting

INTRODUCING THE MOST USEFUL COMPUTER TO COME ALONG IN THE LAST 15 MILLION YEARS.

The new Toshiba T2000SX

The first computers were large and crude. Over time, they became smaller and smarter. Today, computers have reached their highest form in what is called the Toshiba T2000SX notebook computer.

Quite simply, the T2000SX is a more useful personal computer because it allows you to work how you want to work. When you want to work. And where you want to work.

Built on the philosophy that megahertz and megabytes are just a fraction of what makes a computer truly powerful, the T2000SX takes personal computing to a new level.

Yes, it has a fast 386SX processor, a VGA compatible display and up to 40 megabytes of hard disk storage just like any computer worth its silicon. But what makes the T2000SX so remarkable is how easy it is to use. And how often you'll find yourself putting it to use.

You've been working hard. Now, work smart.

Weighing a scant 6.9 pounds, the T2000SX fits easily into a briefcase and is ready to go when you are. Having it with you means no longer having to waste time going back to the office to enter data, make revisions or hunt down information. Everything you need will always be with you.

Like the desktop computer you grew up on, the T2000SX has a complete set of industry standard ports, full modem capabilities and, of course, it can run thousands of programs: Lotus® 1-2-3, Microsoft® Windows® 3.0, WordPerfect®, you name it.

It also has a revolutionary feature you won't find on any other brand of computer in existence.

It's called AutoResume.

The T2000SX is a revolutionary computer that allows you to shut your computer down and start up precisely where you left off. Without the hassle of rebooting, restarting applications and reloading files.

AutoResume. Think of it as the computer equivalent to a bookmark.

Simply put, AutoResume saves you time. Shut down most other computers and when you're ready to start up again, you have to go through the tedious process of booting up, starting the program and loading the file you were using before.

But with the T2000SX's AutoResume, you can go immediately to where you last left off.

No booting. No searching. No waiting.

In addition, unlike other portable computers, AutoResume automatically saves your work if your battery runs out—allowing you time to change batteries or recharge without losing an ounce of information.

What does it all mean?

You've just received a small taste of what the T2000SX is all about. It means you can make those revisions the client wants right in the client's office. It means you can close a deal at 35,000 feet. It means you'll have a computer you will use more often and in more ways than you ever dreamed of. We invite you to learn much more about the T2000SX and Toshiba's best-selling line of portable computers by calling 1-800-457-7777 for a complete information kit.

You already possess the highest form of intelligence. Isn't it about time you got the highest form of computer?

In Touch with Tomorrow
TOSHIBA

After testing eight of the top notebook computers on the market, Byte Magazine said, "Buy the Toshiba T2000SX." Wait'll they try the T2000SXe.

every other notebook they tested and lasting twice as long as some.

To get even greater battery life, the T2000SXe offers Toshiba's highly acclaimed AutoResume. A special feature that allows you to shut your computer down and start up precisely where you left off. Without the hassle of rebooting, restarting applications and reloading files.

NOW THERE ARE EVEN MORE CHOICES.

At Toshiba, we've always believed that no one computer is right for everyone. That's why we've also

added a more affordable notebook to our line called the T2000. Featuring a 12MHz, 286 processor, it's designed for people who don't need all the power of the T2000SX or the T2000SXe.

If you'd like to learn more about the world's most useful notebook and portable computers, please call us at 1-800-457-7777.

Well, that's the latest. Three incredible notebooks that fit your needs, your briefcase and now your budget.

Isn't technology wonderful?

In Touch with Tomorrow
TOSHIBA

Now available on CD-ROM!

CORELDRAW!

PC Graphics for Everyone!

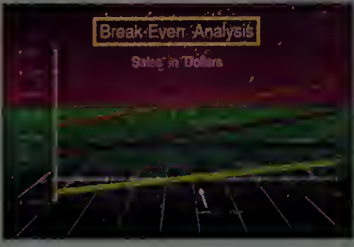

SUPERSALE



It's **FAST**
It's **FUN**
It's **POWERFUL**

LAYOUTS
CORELDRAW!

Easy to Learn / Easy to Use
CORELDRAW's user interface was designed to be intuitive and easy to learn. In the course of one or two hours, you can be up and running. CORELDRAW's user interface was designed to be intuitive and easy to learn. In the course of one or two hours, you can be up and running. CORELDRAW's user interface was designed to be intuitive and easy to learn. In the course of one or two hours, you can be up and running.

Amazing special effects

- envelope (warp) text and graphics
- simulate 3D with perspective function
- extrude to give depth to text/graphics
- blend between shapes and/or colors

Incredible type control

- over 150 fully scalable outline fonts
- see exact fonts on-screen
- paragraph and multi-column text
- import ASCII text files
- fit text to a curve
- create your own fonts or symbols

Superb value

- over 4000 symbols and clipart images
- dotted and dashed line styles
- over 80 arrowheads
- dozens of vector and bitmap patterns
- free Pantone* license
- 24 bit color supported
- 31 import/export filters
- CorelTRACE - batch autotrace utility
- MOSAIC - visual file manager
- WFNBOSS - typeface converter



COREL



Tel: (613) 728-8200
Fax: (613) 761-9176

Call customer service: (613) 728-8200 for information and a free demo disk
*Pantone, Inc.'s check-standard trademark for color reproduction and reproduction materials.
Requires MS-WINDOWS 3.0

Circle 48 on reader service card

Edited by ERIC BENDER

But Cellular Nets Need Data Enhancements

Mobile Professionals Gain Portable Offices

Wireless Links Complement Notebook PCs



With a notebook and portable printer, Bridgestone salespeople can close deals faster, says analyst Mike Withers.

These days we barely notice the telltale antenna of a cellular car phone—except, of course, when the driver is engrossed in conversation rather than the morning traffic. But cellular phones and other communications advances are hooking up with portable PCs to make sales, accounting, engineering, and other mobile professionals as productive on the road as at the office.

Well-publicized and dramatic advances in notebook PCs are being followed by related developments in peripherals and communications. Printers weighing less than three pounds, pocket-sized fax/modems, cellular modems, paging devices that download messages to a PC—the pieces are starting to fall into place for the mobile professional, says Bill Lempesis, who pub-

lishes *The Lempesis Report* newsletter in Pleasanton, California.

Communications A-Go-Go

At Bridgestone Tires, of Nashville, all 175 district and territory sales managers are equipped with a Toshiba notebook with an internal fax/modem, a portable Kodak Diconix 150 Plus ink jet printer, and a pager. They can log on to the company's mainframe to download E-mail messages or get detailed reports about customers they'll be visiting; send and receive faxes to customers and the home office; and print out contracts and promotional literature from virtually anywhere.

"The key word is timeliness," says Bridgestone spokesperson John Taylor. "Under the old system, it

might be several days before salespeople could get information to customers. In the past, deals have not happened because they did not happen quickly enough."

Other companies rely on wireless communications to give them even tighter links. Claims adjusters for one Northeast insurance company drive minivans outfitted with a PC, a printer, a video camera, a cellular phone, and a full-sized cellular modem. They visit customer sites, assess vehicle damage, and send reports with photos back to the home office via the cellular modem. They can write out checks for repairs on the spot. In the past, the process took two weeks.

Walk Before You Run

Companies of all sizes have compelling uses for wireless products and services, says International Data analyst Bruce Stephen, but the com-

mercialization of wireless communications devices remains in its infancy.

Pocket cellular fax/modems are cheaper, but "cellular networks are still too messy for good data transmission," says Dataquest analyst Larry Cynar. Uneven geographical coverage, crowded communications channels, and the low quality of most networks plague customers trying to make the cellular leap. Fax/modem hardware advances combined with Microcom's new MNP 10 communications protocol should help considerably, says Lisa Simpson, product line manager for Rockwell International's Digital Communications Division.

Despite problems, computer companies see communications as an important element of future PC sales. AT&T is pushing harder than most with its Safari notebook, which features an optional cellular modem and portable paging device for downloading messages to the laptop. The potential market, says AT&T vice president Ed Cote, is 26 million professionals who spend most of their day out of the office. —*Roberta Furger*



Mobile professionals don't have to leave home without a notebook PC, cellular phone, pager, or portable fax machine.

It's Not Products That Keep IBM on Top

Buyers Choose Stability and Support Over Price

In the Birmingham IBM PC User Group in Birmingham, Alabama, only two members own IBM PCs—old PCs at that. The group's other members bought compatibles because they "are aware there are better alternatives," says President Everett Huffman.

But customers keep buying from IBM—a lot of customers. IBM sold more than 1.5 million PCs last year in the United States alone, according to International Data Corporation estimates. "IBM has a strong presence in virtually all

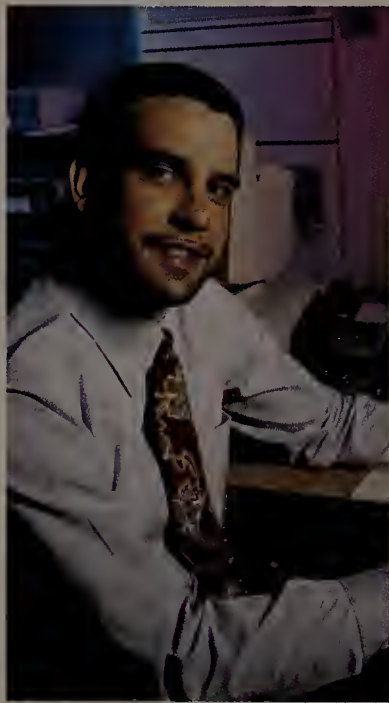

Oil-Dri's Sam Colello applauds IBM service and support.

market segments, even the home market, and we anticipate it will remain the leading PC vendor," says IDC analyst Bruce Stephen.

Achieving High Comfort Levels

Why do so many users still choose to pay a premium for what many reviewers and customers agree are middle-of-the-road PCs?

First and foremost is the peace of mind that comes from dealing with the largest ven-

dor. "This is particularly valuable at a time when there's so much uncertainty in the marketplace," says Bruce Johnson, PC manager at New York City law firm Sullivan & Cromwell. In these troubled times, it's comforting to buy a machine with those three magic letters on it, says Johnson.

Second comes service, particularly at large "True Blue" companies. "There are things more important than saving money," says Avery Cloud, manager of technical services at Bowman Gray/Baptist Hospital in Winston-Salem, North Carolina. An IBM representative is assigned permanently on site, and "the legendary IBM service and support are a reality for us," says Cloud.

For Oil-Dri of America, a Chicago mineral mining and manufacturing firm with six remote sites across the country, a single service contract that covers all PCs is essential. And, says MIS director Sam Colello, IBM was the only choice. "If I have a problem with a PC at a remote site, night or day, I make one call, and the problem is fixed," he says. "There's no finger pointing because I have nonstandard equipment. The support and service IBM gives us when something goes wrong exceeds the \$500 or \$1000 we'd save buying a clone."

Smaller firms also can share benefits from buying IBM. Not only can they get a machine repaired anywhere in the country at virtually a moment's notice, the repairs generally are cheaper because standard IBM parts are widely available. Moreover, the annual maintenance contract for an IBM PS/2 is usually several hundred dollars less than a contract on a no-name clone.

Connectivity and Compatibility

Additionally, connectivity remains a major issue. At First Security National Bank &

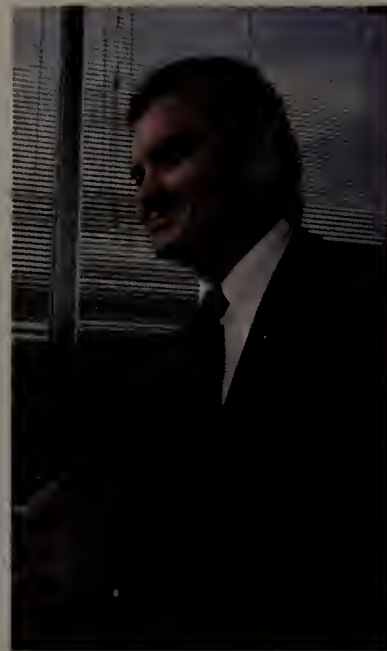

First Security's Brian Williamson can't connect with clones.

Trust in Lexington, Kentucky, PC services manager Brian Williamson admits that his organization "pays a penalty for buying IBM, and we know it." Still, says Williamson, as the bank's systems are increasingly being connected via networks, he's glad that he stuck with IBM. "As simple and economical as it sounds to buy from the low-cost provider, as soon as you try connecting clones, everything falls apart," he explains.

Mike Balog, president of PCI Engineering in Timonium, Maryland, admits that "the productivity-per-dollar ratio is probably lower than what you'd get with an Everex." However, Balog invested in five high-end PS/2s for his engineering consulting firm because of compatibility concerns. "As consulting engineers, the last thing we need to do is chase down software

bugs," he says.

IBM's recent attempts to be more of a technology leader have won the company some grudging fans. "To be honest with you, I don't like IBM," says Hank Swan, owner of Atlantic Automobile Repairs in Baltimore. "As a small buyer, you're cut off from direct contact with the manufacturer and literally at the mercy of the local dealer." However, he bought IBM's portable 386 PS/2 because of its "technical punch."

Even IBM diehards see room for improvement. First Security's Williamson laments that IBM is often slow to get important products to market. Sullivan & Cromwell's Johnson wishes he didn't have to wait in line at his dealer for certain machines. And Oil-Dri's Colello voices what seems to be an age-old complaint: difficulty in prying product information out of Big Blue. But none are miffed enough to change brands.

—Alice LaPlante

IBM Still Takes Biggest Slice

Percentage of 1990 U.S. unit shipments of personal computers

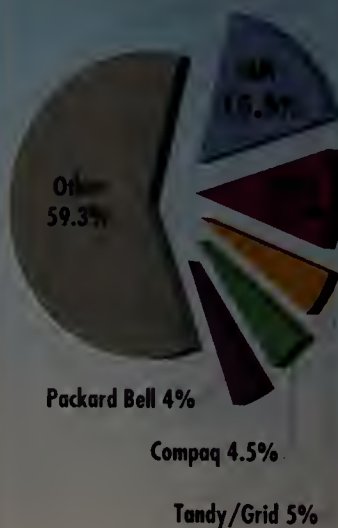

Last year IBM easily held top place in U.S. personal computer sales, with about one-sixth of the 9.5 million systems shipped, according to International Data Corporation estimates.

Printer Sharing Solutions

5 or 10 Ports

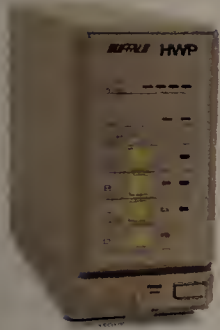

- * **Reliable Automatic Switching**
- * **Easy to Install and Use**
- * **No PC RAM Memory Required**
- * **Toll-Free Technical Support**
- * **45-Day Money-Back Guarantee**



HWP 5 Ports

HWP-256	with 256KB	\$325
HWP-512	with 512KB	\$375
HWP-1000	with 1MB	\$425

User Upgradable Memory:
From 256KB to 16MB buffer

Input/Output Settings – 4/1 or 3/2:
All parallel ports; user configurable as either three inputs to two outputs, or four inputs to one output, buffered auto-switch

Rapid Data Transfer – 100,000 cps:
The HWP uses Direct Memory Access (DMA) for data transfers into the buffer, making the HWP hardware capable of receiving parallel data at the high rate of 100,000 characters per second.

Pop-up Menu or Front Panel Buttons:
Use either the pop-up menu or the front panel switches to select printers, select the next available printer, send multiple copies, clear data, and other functions.

AS-41 5 Ports \$200

Smart Switch – No Pop-up or Buffer:
Four parallel inputs to one parallel output, electronic automatic switch with no buffer

SPPS (not shown) \$100

Interface Converter – No Buffer
Combination serial-to-parallel, or parallel-to-serial interface converter in a single unit; low-power CMOS design derives power from serial connection, no power supply needed; supports 9,600 to 115,200 bps, DIP switch configurable

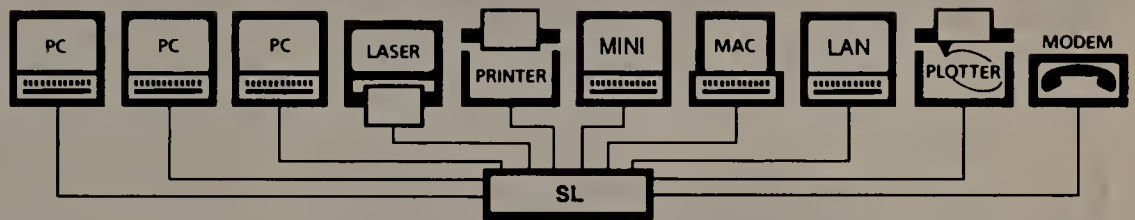

Save Money by Sharing Office Resources:

The SL is the peripheral sharing solution which enables everyone to share lasers, printers, plotters, and modems. The HWP is ideally suited for sending large graphics files, but is economical enough for any kind of printing within a small workgroup.

Greater access by more users reduces unproductive idle time and the expense of purchasing additional peripherals. With a buffer, all users can simultaneously send print data and quickly release their PCs to continue working.



We are the world's largest manufacturer of buffered data switches for PCs which assures your getting the best value and highest performance from our products.

Call For More Information
(800) 345-2356

Fax (503) 585-4505

Buffalo Products, Inc.
2805 19th St. SE, Salem, OR 97302-1520

SL or SLP 10 Ports

SL or SLP-256	with 256KB	\$495
SL or SLP-512	with 512KB	\$575
SL or SLP-1000	with 1MB	\$675

Two Configurations – Ten Ports Each:
SL – four parallel and six serial ports
SLP – eight parallel and two serial ports
Both include 15 ft. serial null-modem cable

User Upgradable Memory:
From 256KB to 4MB buffer

Any Combination of Printers or PCs:
All ten SL or SLP ports can be software configured as either input or output.

Automatically Routes and Buffers Data:
Automatic switching and queuing of jobs; automatically converts data from parallel-to-serial or serial-to-parallel

115,200 bps PC-to-PC File Transfers:
Transfer files serially between PCs up to 115,200 bps; buffer serial data to the SL several times faster than normal 9,600 bps

Pop-up Menu via Hotkeys or Mouse:
Keyboard selection of printers and many other control functions; pop-up is for convenience, but is not required

Simple Installation:
Plug in your cables; if desired, run the installation software for the pop-up menu

Entry-Level Nets Pay Off

Users Like Simplicity, Lower Cost



NetWare's requirements were "mind-boggling," says RhoMed's Dan Swearingen, who chose an inexpensive network alternative.

Ever feel you're being persuaded to throw more technology at a problem than it warrants? That may well happen when you put together a local area network. Powerful net software like Novell's NetWare is well-suited to moderate-to-large installations, but for small organizations, it's like trying to swat a gnat with a sledgehammer.

Fortunately, other networking products allow a half dozen or so PCs to share files and printers quite adequately—and don't require a computer science degree for installation and maintenance. What's more, these net hardware/software combinations cost quite a bit less than full-featured systems. That has translated into substantial sales: Category leader Artisoft of Tucson, Arizona, claims more than 300,000 nodes.

Simpler Solutions

At RhoMed, a research and development firm in Albuquerque, New Mexico, ten PCs are linked over an *Invisible Net*

LAN from Invisible Software, of Foster City, California. Scientists and attorneys run standard applications such as *WordPerfect* and *Paradox*, says Dan Swearingen, the company's controller, and this capability was essential. The network transmits data at rates of up to 3 million bits per second (Mbps) over twisted-pair cabling.

"With Novell, it was mind-

boggling what we'd have had to get—a dedicated server, consultant, cards, and software," Swearingen says. "We were told it would cost about \$10,000." In comparison, the company spent just \$2500 on its *Invisible Net* LAN, he says.

The package was relatively easy to install, and it has been modified recently to be even easier, says Swearingen. Ongoing support is cheaper as well because the manufacturer doesn't charge for technical support. And the package doesn't require dedicating a PC as net server. "I'm really glad we don't have that kind of setup," he says now. "Ours is a lot more flexible."

In Phoenix, Cullen/Burr Associates Architects turned to *LANtastic* products, says Mike Montgomery, CAD manager. The company chose *LANtastic* for its slim memory usage and its manufacturer support. "Originally we had two CAD stations, and we wanted to be able to share the drawing files," Montgomery explains. The company now has seven PCs and runs applications such as *WordPerfect* over the network as well. With 2-Mbps adapters, the total came to less than \$250 per PC.

"Of course you're making a trade-off for speed; we knew

that going in," says Montgomery. The company's 200K to 300K drawing files transmit in about 15 seconds, which he says is acceptable.

SED Systems, a space engineering company in Saskatoon, Saskatchewan, Canada, employs *LANtastic* to allow its four secretaries to share word processing files. "We wanted a real quick system to network our secretarial staff," explains network coordinator Tom Dzubin.

Dzubin confirms that *LANtastic* is "very inexpensive"; total cost with an Ethernet adapter was \$300 per PC. The networks are also easy to set up. "It took me 15 minutes for the first two nodes and 3 minutes for the last nodes," he says. Performance is acceptable, according to Dzubin, with a 1MB file transmitted in about 15 seconds.

Net Disadvantages

Low-end networks may suffer from other drawbacks. Foremost among these, the nets generally don't scale well. Swearingen, for example, was told that Invisible Software doesn't recommend more than 15 PCs on a network. So if your network needs grow, you essentially must trash the network software and start over, though you may be able to keep the network adapters. *LANtastic*, however, lets you install multiple servers and connect nets via a hub.

For small organizations, these products can satisfy limited network requirements with a minimal investment of time and money. "What we like about [the small net] is, it's no more sophisticated than we are," explains Swearingen. —Sharon Fisher

Sharon Fisher is a San Francisco-based freelance author, and Alice LaPlante is a Palo Alto, California, writer.

Entry-Level LANs Find a Place

How entry-level networks stack up against NetWare and its peers

Advantages

- Lower cost
- Don't require a server
- Use less memory
- Support can be cheaper
- Easy to set up and maintain

Disadvantages

- Can be slow (though some support ethernet)
- Nonstandard
- Limited number of nodes
- Limited network radius
- Lack of software upgrade path



Local area network products that aim for ease of use and low cost, such as Artisoft's *LANtastic*, offer many benefits. Performance and upgrade paths, however, may be restricted.

You're one of millions who started with this vision of productivity...

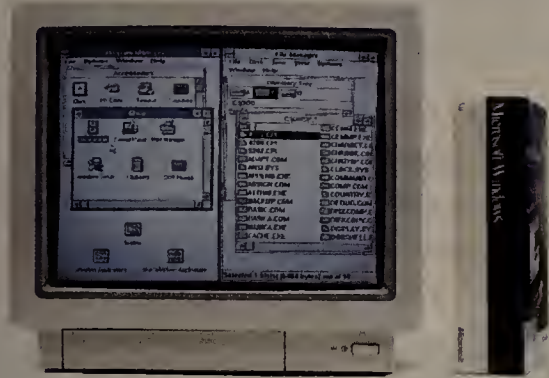

...and are about to discover how to actually achieve it.

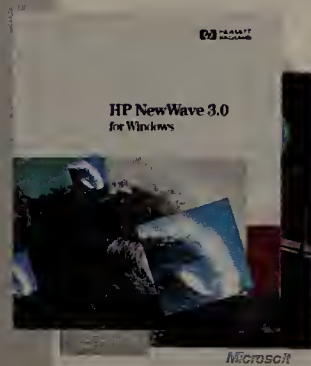
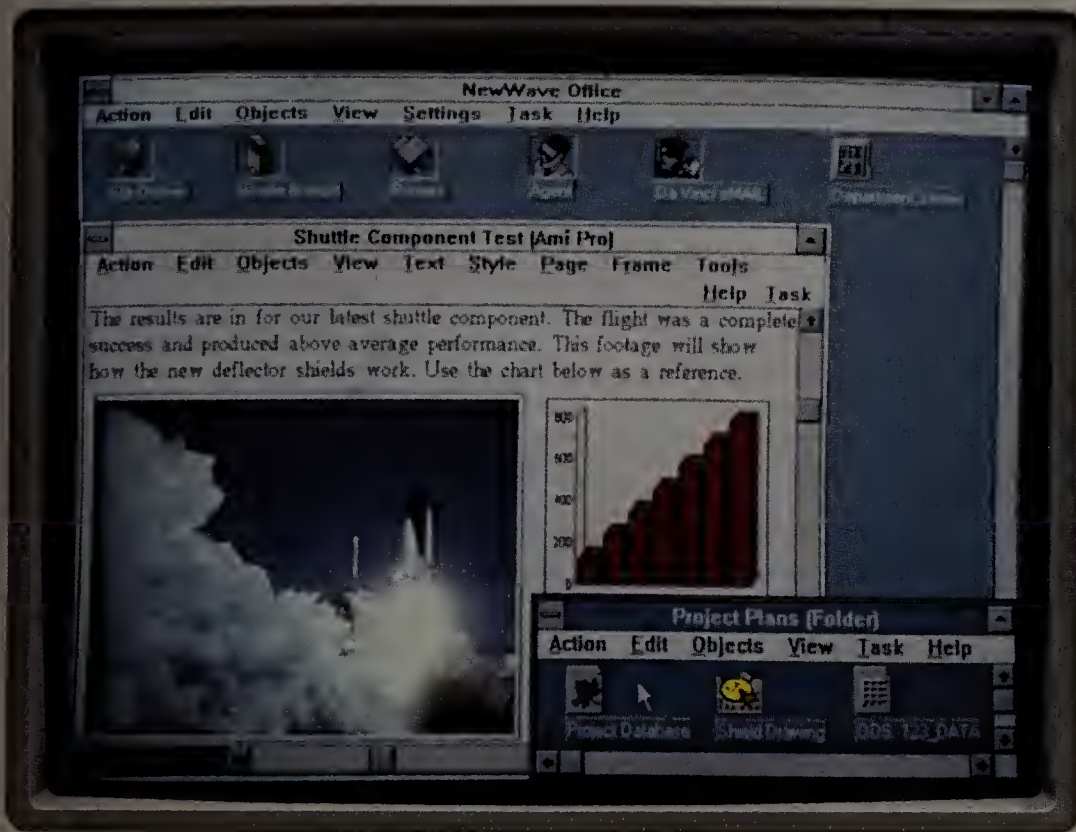

HP NewWave teamed with Windows has been chosen over Windows alone as PC Magazine's 1990 "Environment of the Year."

Words can't capture what HP NewWave software adds to Windows. You have to experience it in motion.

Get our interactive demo disk, and you'll know why the editors of PC Magazine chose NewWave as "Environment of the Year." You'll discover:

- how much easier NewWave is to learn and use than Windows alone.
- how much simpler it is to combine information from word-processing, spreadsheet, graphics and other applications, for greater impact.

• how only NewWave can perform everyday tasks like sales reports and inventory updates automatically, even while you're home asleep.

To put it simply, people had hopes for Windows, but it's NewWave with Windows that really delivers on them. Don't take our word for it, get our interactive demo disk. (\$3.95 handling charge)



Call 1 800 345 9111 x232



Act now for a \$25 rebate

Buy HP NewWave between 7/1/91 and 10/31/91, then send this coupon, original product registration card, and your sales receipt to HP Program Awards Center, P.O. Box 59058, Minneapolis, MN 55459-0058. Must be postmarked by 11/30/91.*

Name & Title

Company

Phone

Street address

City, state, zip.

*Dealers of HP products and their employees not eligible. Allow 6-8 weeks for your check to arrive.



The AST Premium II 486SX/20 and Zeos Notebook 286 were the most aggressively priced desktop and portable PCs during the current reporting period.

Best-Sellers

Leading PCs sold through traditional computer dealers

- | | |
|------------------------------|--------------------------|
| 1 IBM PS/2 Model 55 SX | 6 Compaq Deskpro 386s/20 |
| 2 IBM PS/2 Model 70 061, 121 | 7 Compaq LTE 386s/30 |
| 3 NEC PowerMate SX | 8 Compaq Deskpro 386n |
| 4 Compaq Deskpro 386s | 9 Compaq Deskpro 386/20 |
| 5 IBM PS/2 Model 30/286 | 10 Compaq LTE/286 |

While IBM's PS/2 Model 55 SX kept its sales lead through the dealer channel, Compaq had six of the top ten, according to Storeboard/Computer Intelligence's latest survey.

BARGAINS OF THE MONTH

Over the Counter

What you pay at retail for popular PCs

Configuration	Configuration				National			Boston	Chicago	Dallas/ Ft. Worth
	Speed (MHz)	RAM (MB)	Hard disk (MB)	Video adapter	List	Average	Low			
80386SX-based desktop PCs										
AST Bravo/386SX	16	2	40	VGA	\$2845	\$2153	\$1699	\$2178	\$2097	\$2157
Compaq Deskpro 386s	16	2	40	VGA	\$2399	\$1955	\$1319	\$1966	\$1855	\$1895
Compaq Deskpro 386s/20	20	2	60	VGA	\$2899	\$2367	\$1829	\$2389	\$2337	\$2218
Dell System 320 LX	20	1	40	VGA	\$2100	\$2100	\$2100	\$2100	\$2100	\$2100
Epson Equity 386SX/20 Plus	16	2	40	VGA	\$3449	\$2486	\$1725	\$2566	\$2543	\$2466
IBM PS/2 55 SX-061	16	2	60	VGA	\$3295	\$2415	\$1648	\$2449	\$2322	\$2323
NEC PowerMate SX/20	20	2	42	none	\$2799	\$1966	\$1400	\$1996	\$2003	\$1853
80386DX-based desktop PCs										
AST Premium 386/25	25	2	110	VGA	\$5595	\$3979	\$2798	\$4226	\$4043	\$4207
Compaq Deskpro 386/33L	33	4	120	VGA	\$6199	\$5066	\$4339	\$5111	\$4998	\$4742
Dell 333P	33	4	100	VGA	\$3000	\$3000	\$3000	\$3000	\$3000	\$3000
Epson Equity 386/25 Plus	25	2	100	VGA	\$4999	\$3437	\$2500	\$3692	\$3443	\$3059
IBM PS/2 70-A61	25	2	60	VGA	\$5845	\$4315	\$2922	\$3876	\$4282	\$4121
Tandon 386/33	33	4	110	VGA	\$3279	\$3279	\$3279	\$3279	\$3279	\$3279
Tandy 4033 LX	33	2	105	VGA	\$5898	\$5898	\$5898	\$5898	\$5898	\$5898
80486SX-based desktop PCs										
ALR BusinessVEISA	20	1	80	none	\$3495	\$2807	\$1749	n/a ¹	\$2425	n/a ¹
AST Premium II 486SX/20	20	4	80	VGA	\$3695	\$2932	\$2586	\$2818	\$3018	\$2864
IBM PS/2 90XP-OG5	20	4	80	XGA	\$8345	\$6375	\$4172	\$6259	\$6649	\$6204
80486DX-based desktop PCs										
AST Premium 486/25E	25	4	110	VGA	\$8595	\$6273	\$4499	\$6735	\$6131	\$6441
Compaq Deskpro 486/33L	33	4	120	VGA	\$10,099	\$8172	\$5500	\$8240	\$8290	\$7726
IBM PS/2 95 XP	33	4	320	XGA	\$16,445	\$12,187	\$8222	\$11,560	\$12,736	\$11,594
NEC PowerMate 486/25E	25	4	140	none	\$9899	\$6912	\$4950	\$7031	\$6809	\$6967
Portables/laptops										
Compaq LTE/286	12	640K	20	CGA-LCD	\$2499	\$2068	\$1749	\$2042	\$2004	\$1941
Compaq LTE 386s/20	20	2	30	VGA-LCD	\$4399	\$3581	\$3079	\$3598	\$3585	\$3416
Dell 320LT	20	2	40	VGA-LCD	\$3299	\$3299	\$3299	\$3299	\$3299	\$3299
Epson Equity LT-386SX	16	2	40	VGA-LCD	\$4998	\$3311	\$2499	\$3453	\$3326	\$3168
IBM PS/2 L40 SX	20	2	60	VGA-LCD	\$5995	\$4485	\$2998	\$4440	\$4469	\$4336
NEC ProSpeed 286	16	1	20	VGA-LCD	\$3899	\$2882	\$1949	\$2843	\$2795	\$2787
Toshiba T1200XE	12	1	20	CGA-LCD	\$2299	\$2149	\$1698	\$2307	\$2290	\$2027
Toshiba T2000SX	16	1	40	VGA-LCD	\$3749	\$3642	\$2750	\$3599	\$3896	\$3179
Zeos Notebook 286	12	1	20	VGA-LCD	\$1995	\$1995	\$1995	\$1995	\$1995	\$1995

From an IDC survey of more than 180 computer dealers in eight metropolitan areas. Figures based on at least four price quotes for each machine. Prices are based on manufacturer's standard configuration without monitor. ¹IDC was unable to collect enough price quotes for this model in this metropolitan area due to limited dealer coverage.

Trend Line: Midrange Systems

Average street cast for popular 25-MHz 386 PCs over six months

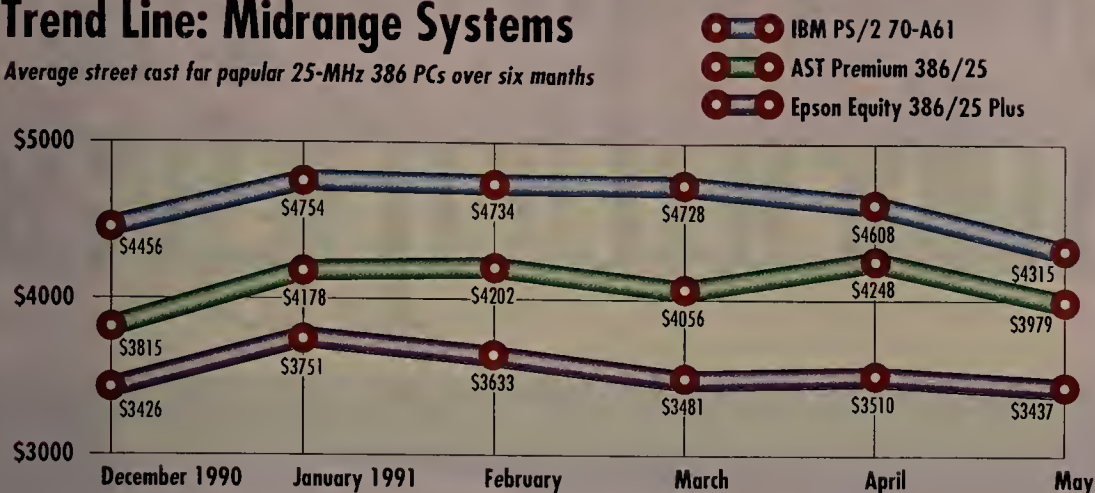

System prices typically vary widely with the buying season. After rising and falling erratically this winter, prices in the popular 25-MHz 386 PC category finally succumbed this spring to strong downward pressure brought on by weak demand and increasingly discriminating buyers. What the numbers don't reveal are additional system enhancements that are being included for the same price.

PC Futures: Price Push Comes to Shove

AST's Premium II 486SX/20 debuted at a strikingly low price in May and is the desktop Bargain of the Month², while Zeos's Notebook 286 garnered portable PC Bargain of the Month honors. IBM's veteran PS/2 Model 55 SX continued to reign on the best-seller charts, although Compaq held more of the top ten slots. Price continues to drop throughout the industry. IBM slashed prices as much as 38 percent during its second round of cuts within a month, and many other vendors followed suit. For example, the base price on Compaq's Deskpro 386s dropped 20 percent, and street pricing fell 19 percent; IBM cut list price 11 percent on the PS/2 Model 55 SX-061, and street pricing slid 8 percent. Prices on 386 machines should be whittled further as models built around Intel's new 486SX chip ship in volume. Vendors will continue to feel strong pricing pressure during the rest of the year as market growth remains slow.

Compaq, IBM Slash Prices

List prices on selected models before and after cuts

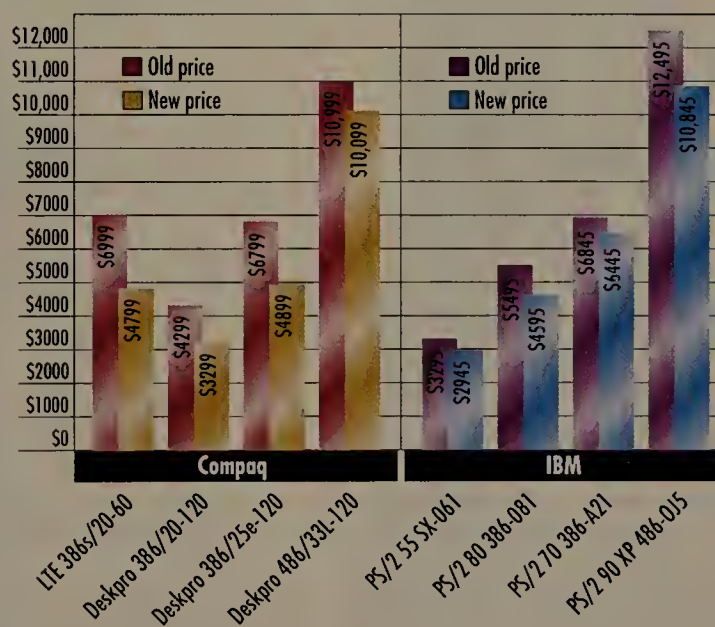

The two leading PC suppliers cut prices substantially this spring, and dozens of other manufacturers followed suit.

² Bargains of the Month are determined by adjusting prices on PCs of a given class for standard memory and storage, then finding which PC compares best.

Metropolitan

Los Angeles	Miami/ Ft. Lauderdale	New York	San Francisco Bay Area	Washington, D.C.
\$2032	\$1991	\$2200	\$2276	\$2101
\$1917	\$1888	\$1965	\$2025	\$1980
\$2378	\$2266	\$2372	\$2457	\$2374
\$2100	\$2100	\$2100	\$2100	\$2100
\$2299	\$2359	\$2398	n/a ¹	\$2712
\$2367	\$2478	\$2404	\$2382	\$2569
\$1736	\$2179	\$1851	n/a ¹	\$2114

\$3222	\$3916	\$4128	\$3873	\$3813
\$5069	\$4877	\$5151	\$4763	\$5144
\$3000	\$3000	\$3000	\$3000	\$3000
\$3323	\$3183	\$3473	n/a ¹	\$3378
\$4099	\$4450	\$4421	\$4364	\$4664
\$3279	\$3279	\$3279	\$3279	\$3279
\$5898	\$5898	\$5898	\$5898	\$5898

\$2571	n/a ¹	\$3070	n/a ¹	\$2940
\$2870	n/a ¹	\$2978	\$2771	\$3030
\$5831	\$6315	\$6647	\$6259	\$5831

\$5033	\$6016	\$6206	\$6315	\$6329
\$7876	\$7742	\$8150	\$8035	\$8427
\$11,547	\$12,193	\$12,164	\$12,334	\$13,090
\$6138	\$7060	\$5971	n/a ¹	\$7314

\$2142	\$1984	\$2077	\$2130	\$2042
\$3587	\$3439	\$3627	\$3652	\$3587
\$3299	\$3299	\$3299	\$3299	\$3299
\$3198	\$3249	\$3390	n/a ¹	\$3359
\$4162	\$4563	\$4532	\$4891	\$4796
\$2417	\$3113	\$2890	n/a ¹	\$3061
\$2083	\$2216	\$2068	\$2037	\$2309
\$3704	\$3729	\$3400	\$3423	\$4374
\$1995	\$1995	\$1995	\$1995	\$1995

Now you can upgrade without upgrading

An unimpressive report is something you'll never have to create again.

Align titles or text across a range of columns—left, right, or center—with one simple command.

You can wrap text around graphs automatically.

Add freehand drawings or symbols to call attention to critical data.

A feature that only 1-2-3 offers to DOS spreadsheet users is the ability to embed as many "live" graphs on a worksheet as you'd like.

Improved, 3D-effect graphs can add even more impact to your report.

Mix bold, italics, underlines, colors, and typefaces to create over 100 text style combinations—more than any other spreadsheet.

Thanks to Auto Compress, you can easily make an entire report fit on one page.

WeCycle Waste Corporation
The Materials Research Group Recommendation:
FOCUS: ALUMINUM

... research Group provides the
... continue to

This study conducted by the Materials Research Group provides the basis for our most recent recommendation that WeCycle continue to expand its aluminum recycling capacity by another 70% over the next 6 years. The graph to the right shows the increasing proportion of our business provided by the aluminum division during the past three years, now approximately half of all revenues. It is our opinion that, at this rate of growth, aluminum recycling will continue to offer our company its greatest opportunity for expansion over the next decade, and certainly into the 21st century.

WeCycle Waste Corporation
The Materials Research Group Recommendation:
FOCUS Aluminum

Gross Revenues by Product

	1989	1990	1991
Aluminum			
East	2,323,426	4,019,527	7,315,539
Central	1,372,347	2,374,160	4,320,972
West	1,726,492	2,986,831	5,436,033
Total	5,422,265	9,380,518	17,072,544
Glass			
East	2,496,721	2,567,821	2,798,925
Central	3,598,757	3,217,693	3,507,285
West	4,217,635	4,471,294	4,873,710
Total	10,313,113	10,256,808	11,179,920
Plastics			
East	2,897,493	3,171,243	3,234,668
Central	1,873,938	1,823,697	1,860,171
West	2,378,942	1,967,421	2,006,769
Total	7,150,373	6,962,361	7,101,608

Glass and Plastics
As can be inferred from the graph to the left, glass and plastics recycling has been holding steady throughout this same period, and has consequently become a smaller proportion of our overall sources of revenue. Although this group would strongly recommend that WeCycle Waste Corporation do all that is necessary to increase its activities in these areas, our studies have shown that aluminum will become increasingly the material of choice in the shipping, heavy manufacturing and container industries.

Aluminum
It is our opinion that sources of aluminum products will be pressed close to their limits over the next decade. Therefore, we propose that WeCycle Waste Corporation invest in more aluminum capacity during the next five years in order to take the best advantage of this increasing market demand.

Make your spreadsheet sing your hardware.

There's a lot to like about the new Lotus® 1-2-3® for DOS Release 2.3.

For starters, it's not just a graphical spreadsheet. It's a fast, graphical spreadsheet for DOS. It's easy to use. And it works as well on an older XT with just 512K of memory as it does on the newest 486 machine.

It also shares many features in common with our powerful 3D spreadsheet 1-2-3, Release 3.1. Including its superb spreadsheet formatting and publishing capabilities and full mouse support. Along with its popular Auto Compress feature that gives you a trouble-free way of making larger worksheets print on a single page.

We've also added new features you won't find in other spreadsheets. Like

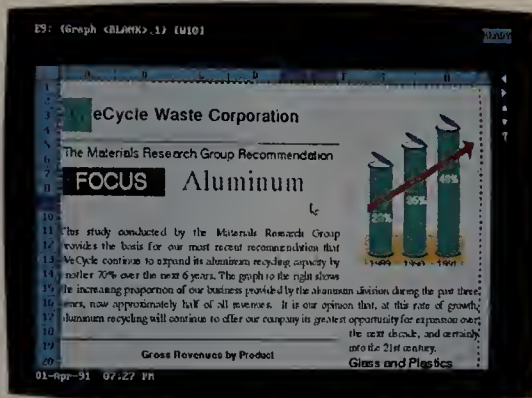

With its WYSIWYG graphical environment, you can do all your formatting "live" on screen.

the Viewer (based on Lotus Magellan® technology) which lets you view files before retrieving them and makes file linking as easy as point and click. And a very helpful Auditor that simplifies the job of documenting and analyzing worksheet logic.

Of course, you won't just like what Release 2.3 does. You'll like how it feels. It's quick and smooth. With a WYSIWYG (what-you-see-is-what-you-get) graphical environment that lets you format text, data, and graphics "live" on screen. With the mouse, you can execute commands, highlight cells or ranges, open dialog boxes, place and size graphs, change type styles, fonts and point sizes. All with unparalleled speed and ease.

What's more, Release 2.3 gives you a wide range of printing and reporting capabilities. Including the capacity to place as many live graphs on a worksheet as you'd like.

Along with 96 type style combinations, drop shadows, new 3D-effect graphs, drawing and annotation tools, and the most font support, choices of colors and shading available.

Compatibility? As with any 1-2-3 product, it's no problem. Because Release 2.3 will read all of the files you've created on previous versions of 1-2-3, including files you've formatted using Allways™ and Impress.™ So you'll preserve all your work, as well as your training.

For more information see your Lotus Authorized Reseller. For a free demo or to order your upgrade directly from Lotus* call 1-800-TRADE-UP, ext. 6002.

What's New In Lotus 1-2-3 Release 2.3.

- A WYSIWYG graphical environment with live on-screen formatting
- Lotus Magellan viewer technology for fast file previewing, retrieving and linking...all without leaving your active worksheet.
- More graph types, including 3D-effect graphs and graph annotation capabilities.
- Auto Compress, for a trouble-free way of making larger worksheets print on single page
- Dialog Boxes for an easier, more interactive way of working
- Text-editing for easy on-sheet word processing, including automatic word wrap, even around graphs
- The Auditor for documenting or highlighting your spreadsheet logic
- Improved memory management for building larger worksheets up to 12 MB in size
- New printer drivers that support all leading laser and dot-matrix printers
- Context-sensitive, interactive Help and an on-line tutorial



*Please have your credit card and product package ready when you call. In Canada, call 1-800-668-1509.

© Copyright 1991 Lotus Development Corporation. All rights reserved. Lotus, 1-2-3, and Magellan are registered trademarks and Impress and Allways are trademarks of Lotus.

The new Lotus 1-2-3 for DOS

Lotus

Introducing the new It will create your next Not to mention



Worldwide Market Overview

- Defend and expand current market share
 - Identify new markets
- Market analysis
- Support existing sales efforts
- Identify areas of risk in light of new competition

Automated Smart Features make it easier than ever to produce everything from simple word charts to impressive flow charts, diagrams and other business drawings.



The new Freelance Graphics for DOS offers a WYSIWYG (what-you-see-is-what-you-get) environment where you work with actual colors and fonts while you're creating your graphics. And with the mouse you can do it all in record time.

Freelance Graphics. presentation beautifully. automatically.

Now there's an even better version of Freelance® Plus, the award-winning graphics program praised by *PC Magazine*, *PC World* and *Software Digest*. It's so improved, in fact, we even changed its name. Introducing Freelance Graphics™ 4.0. The best presentation graphics program for DOS.

For starters, we've added a graphical WYSIWYG environment. Which means you'll work with actual colors and fonts while creating your graphics. Plus, you'll know what your output



For two consecutive years, Software Digest awarded Freelance Plus its highest-rating. Now with Freelance Graphics, we've made the best even better.



Only Freelance Graphics, with its unique automated Smart Features, can turn your rough ideas into a smooth presentation this easily.

will look like before you print.

And with the mouse you'll do it all—from executing menu commands to moving a chart—in record time.

Yet what's really unique about the new Freelance Graphics is its *Smart Features*. Unlike other DOS graphics programs, its hard-working *Smart Features* automate

the process of turning your ideas into persuasive presentations. So while you're concentrating on what you want to say, Freelance Graphics will take care of how it looks. Whether you're creating slides, overheads, or hard copy, in color or black-and-white.

Here are a few of its *Smart Features*:

Portfolio, a built-in presentation manager, helps you organize and prepare your presentation; a Text Chart Outliner,¹ complete with a spell-checker, creates stacks of text charts in seconds; Auto-charting makes weekly or monthly reporting a snap by printing hundreds of up-to-date charts with a single command; Smart Chart Update automatically recomposes a chart whenever the data changes... even if you've added annotations or symbols; and over 1,000 Pre-drawn Symbols and Design Backgrounds.

All of which means you can now create an incredibly impressive presentation. With incredible speed and ease.

The new Freelance Graphics.

It could actually have you looking forward to your next presentation.

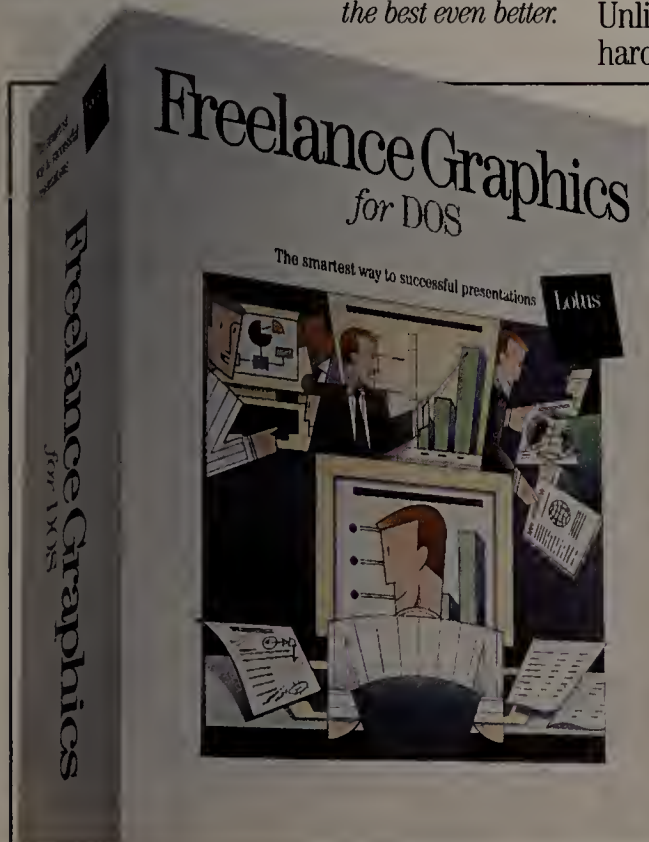

Upgrade to Freelance Graphics now and you won't just save time. You'll save money.

Right now we're offering—direct from Lotus[®]—a price of just \$99.00² for anyone upgrading from an earlier version of Lotus Freelance or Graphwriter, or any other eligible³ graphics program, including Harvard Graphics.

Plus, you'll be covered by the Lotus Technology Guarantee. Which means a guaranteed price of just \$49.00 on our upcoming Freelance Graphics for Windows™ product.

For information or to purchase your upgrade directly from Lotus, call us.⁴ Please have your credit card and eligible product package ready.

1-800-TRADE UP ext. 1209.

¹Developed by Symantec Corporation, especially for Freelance Graphics. ²Offer expires September 30, 1991, after which the Lotus direct upgrade price will be \$119. ³Eligible products for upgrade offer include all versions of the following products: Lotus Freelance Plus or Graphwriter, Harvard Graphics, DrawPerfect, Applause II/Draw Applause, Graph Plus, Charisma, Microsoft Chart, Pixie, Gem Series, ChartMaster, Diagram Master. ⁴Freelance Graphics Upgrade also available at participating Lotus resellers.

Freelance Graphics for DOS

Lotus

EXPERIENCE

Salvation™

Windows Management System

Microsoft® opened your computer with Windows™. Vitesse opens the door for you with Salvation!

Salvation is the friendliest graphic user interface (GUI) available to Windows users. Replace and integrate most Windows file utilities with Salvation.

Salvation's exclusive BUTTON LAUNCHERS™ offers the ability to easily launch either Windows or DOS applications. You automatically or manually program BUTTON LAUNCHERS™ and add your own personal icon.

Salvation file utilities makes management of all your disks a simple task. You can move, copy, delete, rename, or easily create both files and subdirectories. In addition to launching, Salvation automatically handles text and graphics files. Salvation even provides security access to your files.

Salvation's features gives your computer maximum power and the most understandable GUI in the PC environment.

EXPERIENCE SALVATION for only \$179.95 (suggested retail)

Contact your dealer or call Vitesse at (800) 777-7344 FAX (818) 813-1273. DEALER INQUIRES WELCOME. We accept VISA & Mastercharge.

© Copyright 1991 Vitesse, Inc.. All Rights reserved. All company and product names are trademarks of their respective companies.

Circle 299 on reader service card

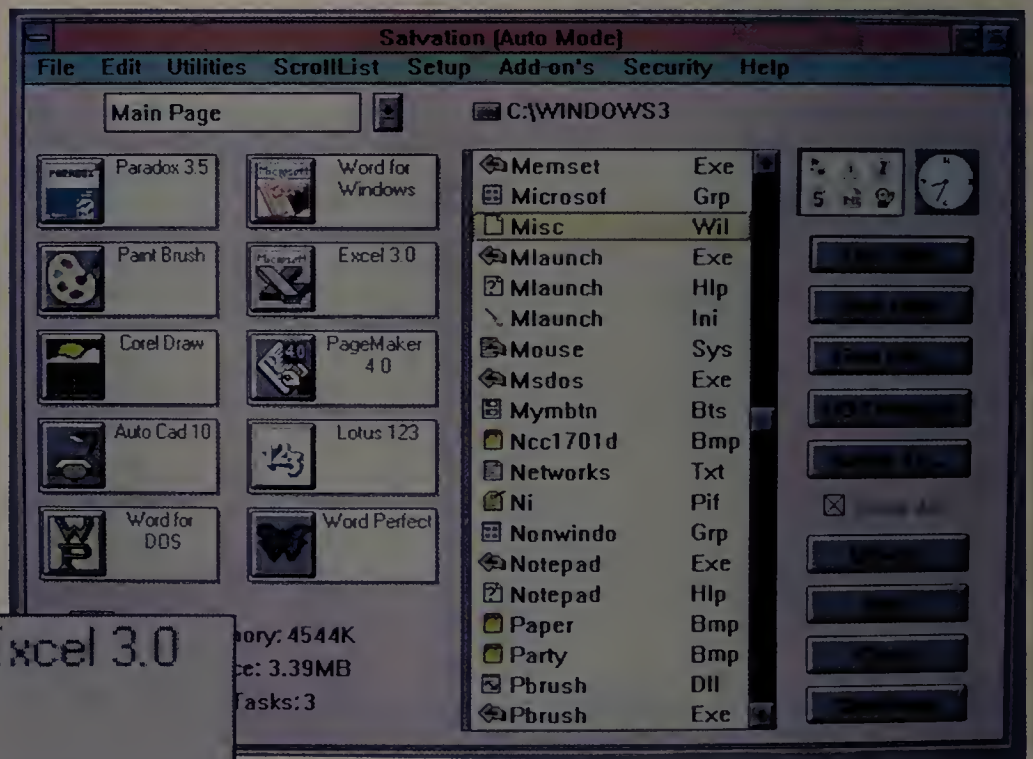
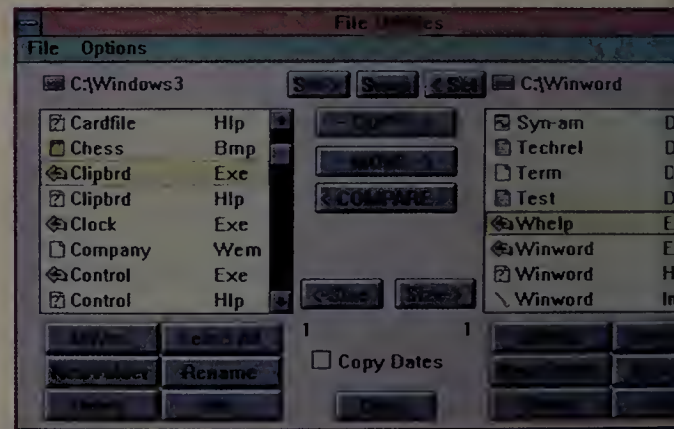

TWO-FISTED MANAGEMENT

TWO-FISTED MANAGEMENT

A billion here, a billion there— pretty soon you're talkin' real expenses.

MARK, 34



YOU KNOW YOUR LAVISH SPENDING WAS VITALLY CRUCIAL TO THE PROPER EXECUTION OF YOUR JOB. IT'S CONVINCING THE OTHERS THAT CAN GET STICKY. TRY THESE

EXPENSE REPORT TIPS



TAKING YOUR ACCOUNTANT ALONG ON THOSE EXOTIC JUNKETS WILL DISPEL ANY PERCEPTIONS OF A "PLEASURE CRUISE."

Good... they put him in the cargo hold. He's on his own when we get to the island.



WHEN USING YOUR ROOM SERVICE MINIBAR DISCUSS ONLY BUSINESS AND ALWAYS IN THE PRESENCE OF A CLIENT/POTENTIAL CLIENT.

O.K., O.K. (hic) but let's just suppose (hic) you were interested in my products... (hic) we'll be needing more gin here...



A FIFTEEN FOOT STRETCH LIMO? CERTAINLY. THE TRICK IS TO MAKE FULL USE OF EVERY SEAT.

O.k., ladies, I've got a meeting. Watch the hubcaps.

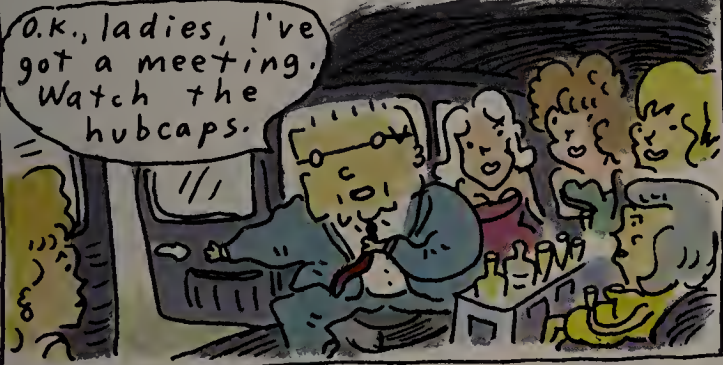

SOLITARY DINING EXTRAVAGANZAS SHOULD BE LISTED AS "RESEARCH."

Quaint... classy... overpriced... perfect for the Zebo clients. Hmm... but would the "penne arrabbiata with pencatta sauce" be satisfactory? We must be sure.



FLASHY LIGHTS, HUSTLERS, LOTS OF LOOSE CASH-- LOOKS LIKE A CONVENTION TO ME



NOW, A BAIL BOND IS A BIT TOUGHER. UNLESS, OF COURSE, IT STEMS DIRECTLY FROM A VALID BUSINESS ENGAGEMENT.

We found him bustin' up the Blue Nugget. Says they were playin' with marked contracts.



MARK MAREK

The New ZEOS[®]

Now '386SX Only \$2295!



Notebook.

'286 Only \$1995!

"THE HOTTEST DEAL ON THE NOTEBOOK MARKET" — PC MAGAZINE



"King of the Hill ... Sensational ... The best price-performer ... Astonishing value ... The number one

contender..." The praise goes on and on. Winner of PC Magazine's Editor's Choice Award and PC World's Best Buy Award, the experts love the ZEOS Notebook. And you'll love it too. Because as PC Magazine said, the ZEOS Notebook is simply "the hottest deal on the notebook market."

INCREDIBLE DESKTOP FEATURES IN A NOTEBOOK.

Pick your power. Choose our '286 version or go for the incredible new ZEOS '386SX version. Combine that with our high speed hard disk, built in 1.44MB floppy drive, VGA and more—you've got the greatest notebook going at any price!

Look closely at the details. Like our crisp 10" VGA display. The ultimate in sparkling clarity featuring advanced fluorescent backlighting for vivid VGA graphics. And then the drives.

Two drives are better than one! First, you're getting our whisper quiet high speed, high capacity hard disk. Then we've built in an industry standard 1.44 Megabyte, 3.5 inch floppy as well. And we don't stop there.

DETAILS MAKE THE DIFFERENCE!

For instance, the battery system of your new notebook is the most advanced on the market. You can quick charge, or trickle charge, any time your system is plugged in. Or, you can use the optional charging stand if you wish.

Either way, you're sure to appreciate our light weight snap-in, snap-out battery packs. They're so light and easy to use, you can easily take an extra one with you on those really

long trips. Plus, you can get even more life out of a single charge by using our programmable power management system. Hour upon hour of Notebook computing power!

CONNECTIVITY TOO!

Your new ZEOS notebook is a great connectivity tool! Using our optional built-in 2400 baud MNP Class 5 modem, connectivity buffs will find themselves logging on at every turn.



And speaking of connectivity, we've kept the I/O easy to use too. Because unlike many of the others, your new ZEOS notebook has the same industry standard port connectors you'll find on your larger desktop system. Serial and Parallel ports; even an external VGA connector. Completely compatible!

ZEOS 24 HOUR A DAY SUPPORT.

Don't forget your new ZEOS notebook is backed

by the best Technical and Sales support in the industry, 24 Hours a Day. We're always here to help, *any time* of the day or night. And we don't stop there either.

Your new notebook is also backed by our 30 Day Absolute Satisfaction Money Back Guarantee and One Full Year Limited Warranty. You're going to be very satisfied. We don't just say it. *We guarantee it.*

ORDER YOUR OWN ZEOS NOTEBOOK NOW!

You can order your own ZEOS Notebook *right now*. Simply pick up the phone and give us a call now at 800-423-5891. Larger hard drives, carrying cases and more are also available! At last, a full featured notebook that lets you compute anywhere. You're going to love it!

ORDER NOW TOLL FREE:

800-423-5891

NOW. YOUR COMPLETE '286 NOTEBOOK! VGA, 20MB HARD DRIVE, 1.44MB FLOPPY AND MORE. LIGHT AND LOADED! INCREDIBLE. ONLY \$1995! 386SX ONLY \$2295!

- '286-12 or '386SX-16.
- 1MB DRAM, expandable to 3 or 5MB.
- 20MB High Speed HDD.
- Built in High Density 3.5" 1.44MB floppy drive.
- High resolution VGA display. Fluorescent backlit 640x480, 32 grey scales. Bright and clear!
- Removable quick charge NiCad battery. Two hour plus battery life typical, more using Programmable Power Management!
- Quick charge or trickle charge using included AC power adapter.
- Extra battery packs and external charging stand available.
- 82 key keyboard. True 101 key emulation.
- Industry standard Serial and Parallel Ports.
- VGA port for external VGA color display. Great for demos!
- Total system weight under 7 lbs. with battery.
- 30 Day Absolute Satisfaction Money Back Guarantee and ZEOS Customer Satisfaction Package.
- One Full Year Limited Warranty.
- 24 Hour a Day Toll Free Technical Support, 365 Days a Year.

ORDER NOW TOLL FREE
800-423-5891

FAX Orders: 612-633-1325
Minnesota: 612-633-4591
Hearing Impaired (TDD)
Orders: 800-228-5389
Outside US and Canada:
612-633-6131

MasterCard, VISA, Discover,
Am Exp, Z-Card and COD.
Open 24 Hours a Day,
365 Days a Year!





ZEOS[®] 386SX-20! Only \$1195.

INCREDIBLE 20MHZ ZERO-WAIT PERFORMANCE \$1195!

That's right! Now you can own the incredible new ZEOS 386SX 20MHz system, complete for only \$1195! Using *ultra high speed* 53 nanosecond DRAM, your new ZEOS 386SX-20 delivers *blazing* zero-wait state performance without the need for a cache. And that's just for starters.

Your new ZEOS 386SX-20 also includes the most advanced SX motherboard available anywhere. Because we've not only added incredibly fast 53ns DRAM, we've also integrated the hard and floppy drive controllers *plus* the serial, parallel and game ports *right on the motherboard!* This results in even greater reliability *and* expandability.

ZEOS SX SYSTEMS RATED #1!

After all, the ZEOS 386SX-20 comes from a family of *Editor's Choice* '386 systems. And most recently, in PC Magazine's Service and Reliability issue, ZEOS systems received the #1 SX rating overall. When you receive your new ZEOS 386SX you'll see why ZEOS is #1. Take our case and power supply for instance.

Your new system will include our custom 200 Watt power supply and seven bay SpaceSaver desktop case.

You save space and still have room for lots of future expandability! And the components in your system will last longer too because ZEOS gives you not just one, but *two cooling fans*. After all, the cooler your system runs, the longer it will last. Now that's uncompromising value. That's ZEOS value.

24 HOUR A DAY TOLL FREE SALES AND TECHNICAL SUPPORT!

Too, you will receive our legendary *ZEOS 24 Hour a Day Toll Free Technical Support*. Plus our full 30 Day Absolute Satisfaction Money Back Guarantee, One Full Year Limited Warranty and Express Parts Replacement Policy.

Performance. Quality. Price. Support. These are the hallmarks that have made ZEOS America's favorite choice. These are the values that make ZEOS your best choice as well. You're going to be *very* satisfied. We don't just say it. *We Guarantee it.*

ORDER NOW TOLL FREE 800-423-5891!

Order your new ZEOS 386SX now with confidence. Your choice of ZEOS quality and performance is Guaranteed. Order now toll free by calling 800-423-5891.

**INCREDIBLE
20 MHz
ZERO-WAIT
PERFORMANCE
ONLY \$1195**

- '386SX-20 CPU, 8/20MHz.
- Ultra Fast 53ns DRAM providing true Zero-Wait state performance.
- 512K memory expandable to a System Total of 16MB. Right on the motherboard.
- 42MB High Speed IDE hard drive. Teac[®] 1.2MB floppy.
- ZEOS 14" Hi-Res amber monitor with Tilt/Swivel. Includes Genuine Hercules[®] brand graphics controller!
- ZEOS/RS 101 key SpaceSaver keyboard.
- Two Serial, one Parallel & one Game Port.
- 6-16, 2-8 bit expansion slots. 80387SX math coprocessor support.
- Rugged ZEOS 7-bay SpaceSaver case with our 200 Watt power supply and two cooling fans for added reliability and product life.
- Includes ZEOS 24 Hour a Day Toll Free Technical Support and Customer Satisfaction package.

Options Galore: Including 14" 1024 VGA, more memory, an incredible selection of hard drives: SCSI, IDE, ESDI RLL or MFM and virtually any other add-on you could want. Ask about other special money saving packages too.

**ORDER NOW TOLL FREE
800-423-5891**

FAX Orders: 612-633-1325
In Minnesota: 612-633-4591
Outside US and Canada:
612-633-6131
MasterCard, VISA, Discover,
Am Exp, Z-CARD and COD.
Open 24 Hours a day,
365 Days a year!

All prices and specifications are subject to change without notice. Please call for current pricing and warranty details. ZEOS is a publicly traded company, NASDAQ Symbol: ZEOS. © 1990 ZEOS International, Ltd., 530 5th Avenue, N.W., St. Paul, MN 55112. All product and company names are trademarks or registered trademarks of their respective holders.

ZEOS
INTERNATIONAL, LTD.

If you expect your dot matrix printer to eat your dust, make sure it has the Okidata OK!™



Okidata dot matrix printers positively thrive in conditions other printers might find too hard to handle.

An Okidata ML[®]320, for instance, has been happily hard at work for years—right in the middle of a dusty Colorado lumber mill. And thousands of other Okidata printers are equally happy getting frozen on Alaskan loading docks, jouncing around in big-city delivery vans, bumping along in busy airport jetways, and working away in a hundred other harsh environments.

That's because every printer Okidata makes just doesn't make it without the

Okidata OK! – Our personal assurance to you that every printer we sell will deliver not just adequate, but outstanding performance, year after hard-working year.

It's performance we've designed in, not just added on. With components like a closed-loop positioning system that continually monitors and adjusts the print-head alignment, even if the printer's been vibrated or bumped. And printer cases made from the same material as pro football helmets. And a host of paper-handling options: top, bottom or rear feed, with easy switching from single-sheet to continuous forms.

There's a rugged Okidata dot matrix printer just right for any dirty job you can throw at it, from 9-pin work horses like the 182T and ML320 to 24-pin power-houses like our ML390 Series.

And every one of them comes with two features no printer that has to work for a living should be without: A hearty appetite for abuse, and the Okidata OK! For more information call 1 (800) OKI-DATA.



We don't just design it to work. We design it to work wonders.™

Okidata and Microline are Reg. T.M. and Okidata OK! is a T. M. of OKI Electric Industry Co., LTD. "We don't just design it to work. We design it to work wonders." is a T.M. of OKI America Inc.

Circle 197 on reader service card

PREVIEW

PC WORLD OFFERS FIRST IMPRESSIONS OF PRERELEASE HARDWARE AND SOFTWARE

1-2-3 Does Windows

Lotus steps into a Windows world of supremely useful icons and stunning output while lending a helping hand to current 1-2-3 users.



You want graphics? Picture this: 1-2-3 for Windows helps you enliven reports and presentations with a variety of graph types plus drawing and text features.

Richard Scoville

COVER STORY In the past year, *Windows* has sold millions of copies, but many users' number one *Windows* application is still Solitaire. Despite the availability of many other excellent *Windows*-based applications, such as Microsoft's *Excel 3.0*, most buyers have been patiently waiting for the other shoe to drop before they make their next move.

Well listen up, folks—Lotus just dropped one. And it's a

real beaut.

1-2-3 for Windows packs the formidable power of *1-2-3* release 3.1+—including 3-D worksheets, high-end data management, and a nonlinear solver—into a unique version of the *Windows* interface ablaze with icons. You can create polished output easily, thanks to full-featured business graphics and scalable fonts. And the environment provides a continuous view of the final product as you work.

Does the new *Windows* interface mean you're in for another trip to the training cen-

ter? Not at all: When you hit the slash key, up pops a free-floating box with the familiar *1-2-3* Classic menus inside. Until you're comfortable with the new system, you can keep on working the old way—and the Classic menus promise 100 percent macro compatibility with previous releases.

Icons to Suit Your Taste

The optional Classic menu is a great idea, but most users will soon want to move on to the picturesque new world of *1-2-3/W*'s icon palette—a set of 70 3-D mouse buttons that

execute a variety of common commands. Like *Excel 3.0*'s tool bar, the palette lets you quickly justify text, format cells, make a graph, and sum data. But it contains a host of other shortcuts that sort tables, traverse worksheets, copy and move data, preview reports, and much more. You needn't display all 70 icons—select only a handful, if you want.

Unlike *Excel*'s tool bar, *1-2-3/W*'s rectangular palette floats—you can place it anywhere on the screen and resize it any way you like. This is

SNAPSHOT

1-2-3 for Windows

WINDOWS The *Windows* version of the most popular spreadsheet of all time offers Classic menus to lure current *1-2-3* users and an innovative icon palette that you can configure to your taste.

KEY FEATURES

- Customizable icon palette
- Optional Classic menus
- Nonlinear solver
- 3-D worksheets
- Full-featured business graphics
- Adobe Type Manager included

AVAILABILITY

Late summer

PRICING

\$595; upgrade from *1-2-3*, *Excel*, and *Quattro Pro* \$150

Lotus Development Corp.

55 Cambridge Pkwy.
Cambridge, MA 02142
800/343-5414,
617/577-8500

Reader service no. 773

clearly the state of the art in icons.

You can even build your own icons and attach custom macros or C programs to them. Developers can store icon palettes in named files and link multiple palettes into a custom interface, putting custom tools and applications gently into the hands of occasional users.

Cutting Back the Menu Tree

The endlessly branching menu system of release 2.3 and 3.1+ has been (mercifully) pruned

named reports and setup strings. This is good news for application developers who need to produce multirange data base reports—the flexibility of the old system makes it much easier to automate these complex print jobs.

Range selection in *1-2-3/W* is somewhat more flexible than in *Excel*. As in *Excel*, you can preselect a range before executing a command, but you can also change your selection freely from inside a dialog box—the dialog boxes magically

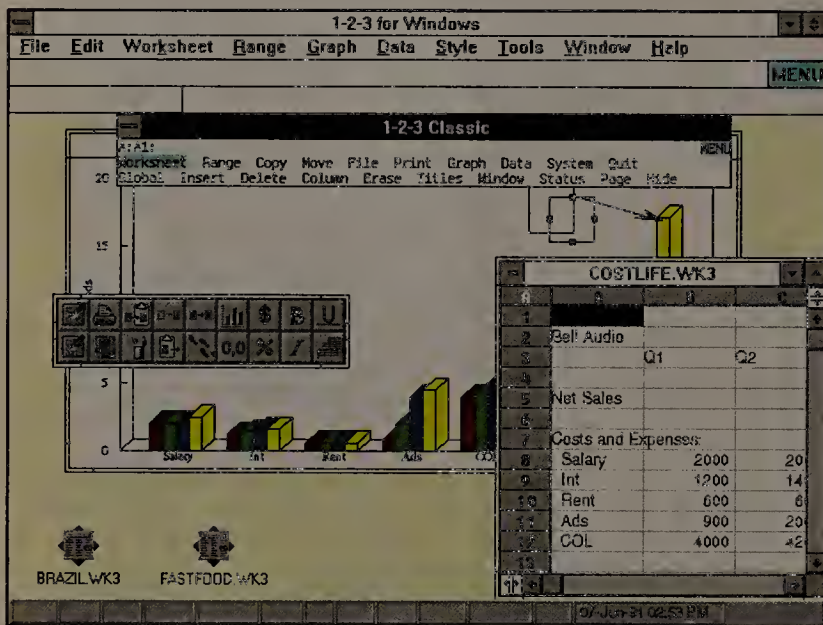

1-2-3 for Windows' optional Classic menus will save thousands of loyal 1-2-3 users countless hours of retraining. When they're ready, they can move on to the new icon palette.

into a manageable set of pull-down menus and well-designed dialog boxes. The result is faster access to controls—for example, the nine-level menu sequence for search and replace is replaced by a single dialog box containing four fields.

To maintain continuity with its DOS forebears, *1-2-3/W* puts a slight spin on the *Windows* interface. In some cases, the offspring manifests a hybrid vigor. For instance, the printing system is now sensibly organized into standard Page Setup and Print dialog boxes, but *1-2-3's* old /Print system retains an independent, ghostly existence in the Classic menus, complete with

dissolve and reappear as you click on the spreadsheet to make a range selection.

In other cases, *1-2-3/W's* *Windows* translations are less fluent. There's no intuitive way to select a 3-D range with the mouse: You must start with a 2-D range, then reach for the keyboard or click on an icon to shift into the next page. Also, to apply a style (a named collection of format features) to a range, you select it from the Style menu, but you must remember to clear it from a separate Edit Style menu.

A Good Family Member

Except for the icon palette and a few *Windows*-specific features, *1-2-3/W* offers few func-

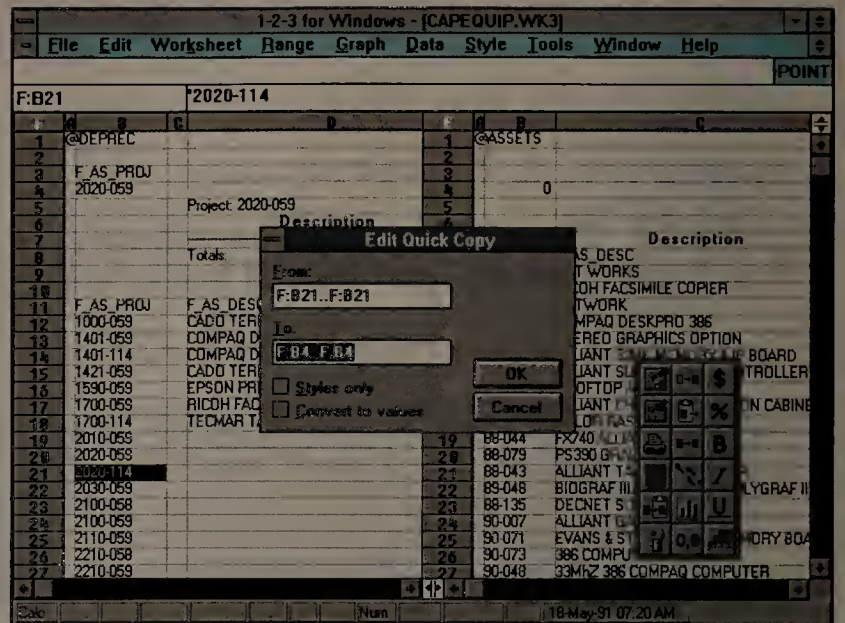

1-2-3 for Windows' slick new icons are the crown jewels of the new interface. You get 70 to choose from, each of which executes a frequently used command, and you can assemble your own icon palette and position it anywhere on screen.

tional innovations above and beyond release 3.1+. The good news is that release 3.1+ is a very capable program, and *1-2-3/W* matches it step for step.

For starters, *1-2-3/W* offers the nonlinear solver. This superb analytical tool lets you work backward from a projected outcome to quickly find optimal solutions. For example, the solver could help you find the biggest profit projection in a range of marketing strategies.

1-2-3/W also shares 3.1+'s relational data base management and external data links,

which make it simpler for developers and power users to organize raw data from reports. A 3-D work space lets you divide a large worksheet into separate pages for easier handling. For developers, the macro language includes new commands to manipulate windows, manage the Clipboard, and establish Dynamic Data Exchange (DDE) links with other *Windows* applications.

1-2-3/W makes it easy to create great output. You can dress up reports with scalable fonts, thanks to the bundled *Adobe Type Manager*. And you can format your reports

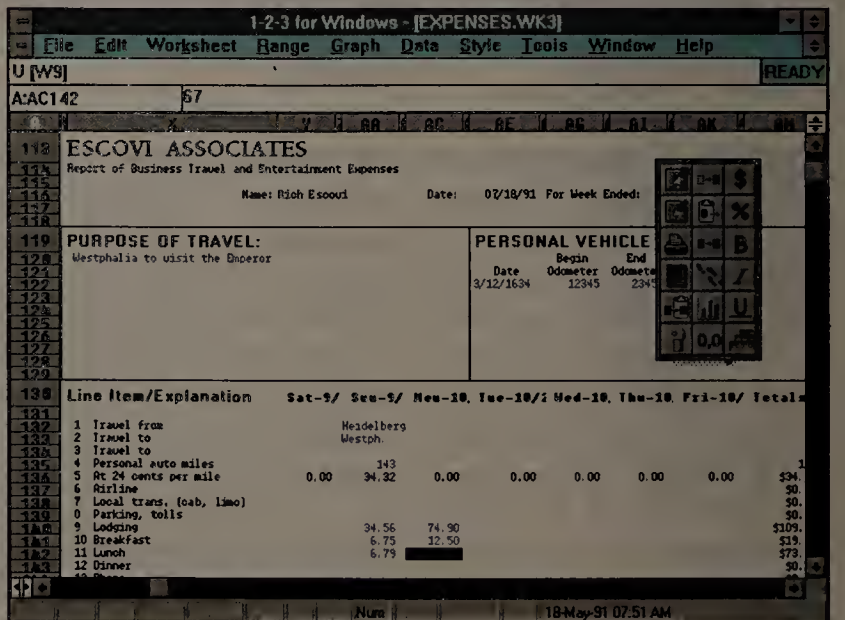

Will the boss approve that whopper of an expense report? With 1-2-3 for Windows, it's easy to use fonts and other formatting refinements to create persuasive documents.

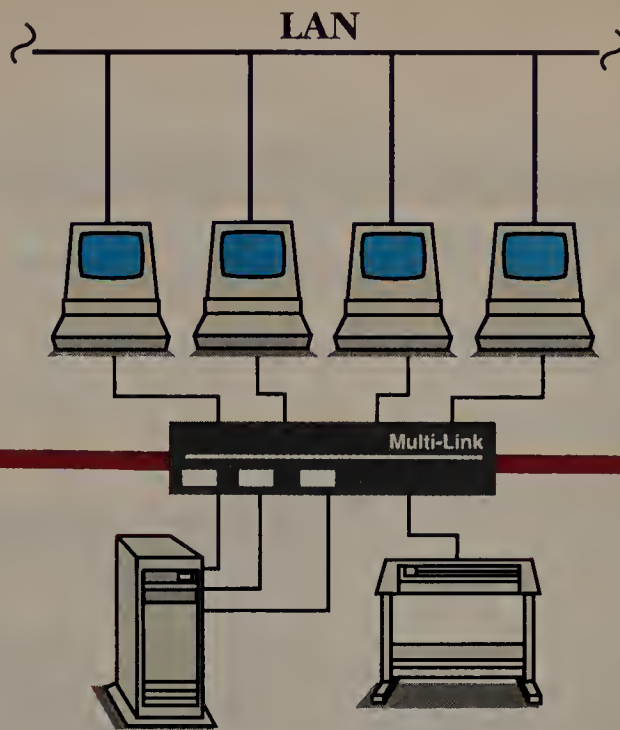
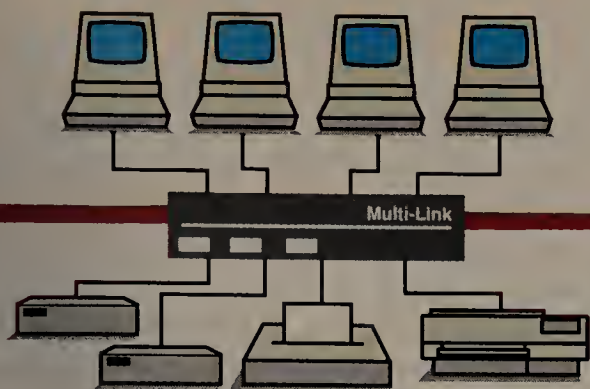

ANY DEVICE AT YOUR FINGERTIPS!

A New, Expandable, Any-Port-To-Any-Port Data Sharing System

Now from Western Telematic, the leader in peripheral sharing, comes an easy, cost-effective way to access any peripheral, any time right from your computer screen. Introducing LASERNET® Multi-Link™ — an expandable, 12-port any-to-any data sharing system for high-speed printer and data sharing.



With Multi-Link, share any device with any device, transfer files between PCs and conduct modem or FAX pooling. And do it over distances of up to 4,000 feet using inexpensive twisted-pair wire!

Flexible, Expandable and Windows® Compatible

Each high-speed port, 8 serial or 4 parallel, can be designated for PCs, printers, plotters, modems, or any RS-232 device. Multi-Link features up to 4MB, field-expandable SIMM memory and a convenient data-link port, which

enables the linking of up to 32 Multi-Link devices. That gives you 384 ports! And peripheral access is at your fingertips with our MS-DOS® or Windows® 3.0-compatible device-select menu.

Increased LAN Efficiency

If you have a LAN, Multi-Link can off-load printing functions for increased efficiency. Now LAN and non-LAN PCs can have access to all office peripheral resources — all for less than \$67 per port!

Set-up Ease and Convenience

An entire system can be configured from one PC. And serial cabling is made practical with telephone-style, snap-in connectors. Parallel ports accept standard PC-to-printer cables.

Multi-Link is compatible with popular word processing, spreadsheet and high-level graphics software, and supports all dot-matrix and laser printers including, HP® and PostScript® printers. Prices start at just \$795 for 256KB memory.

Full Service and Support

Multi-Link is made in the U.S.A., backed by a full **three-year** limited warranty with pre- and post sale technical support. So to get your fingertips on a Multi-Link, call WTI toll free at **1-800-854-7226**, FAX 714-583-9514 or write Western Telematic, 5 Sterling Irvine, CA 92718.

wti western™
telematic inc.
Making good connections.™

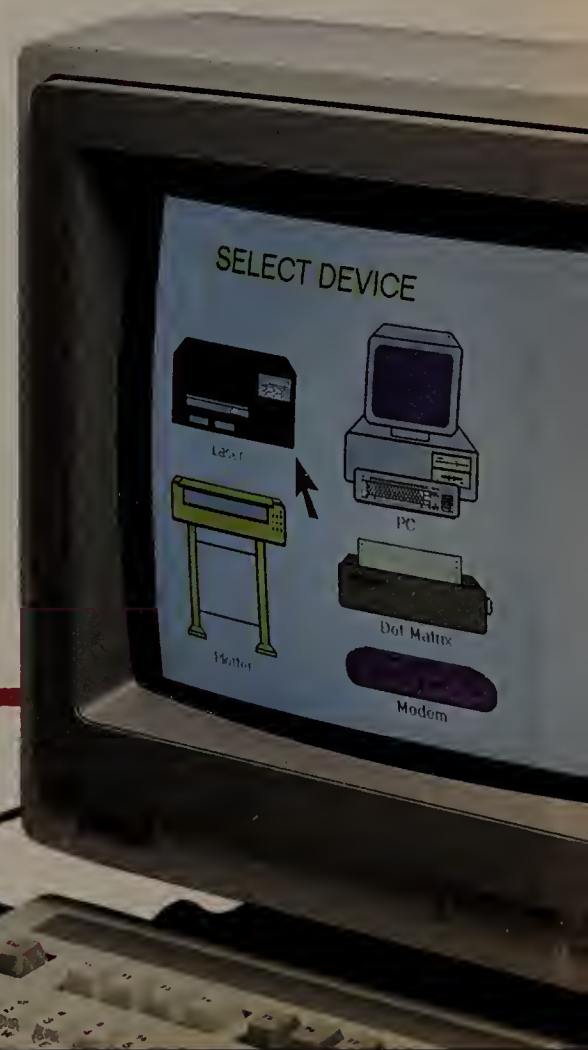

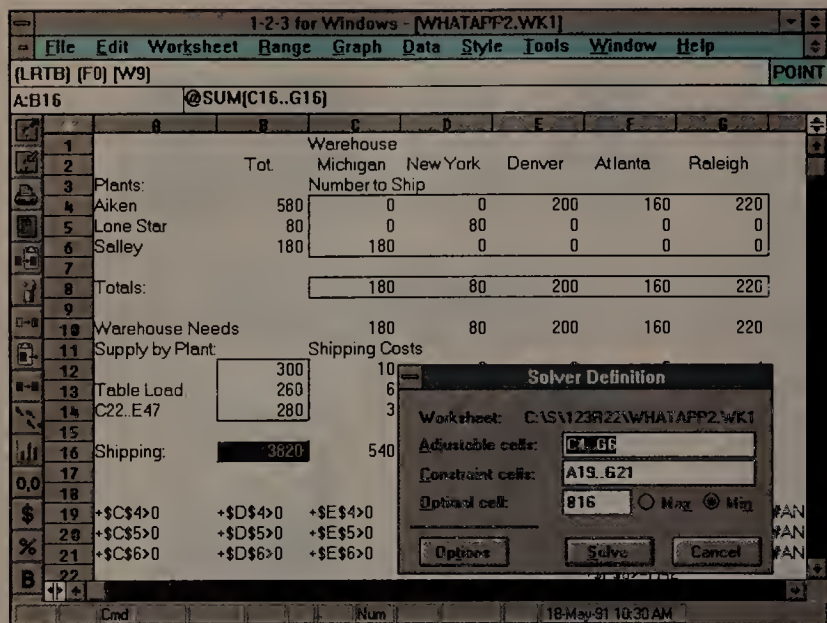

1-2-3 for Windows includes every feature found in 1-2-3 3.1+, including the superb new nonlinear solver. With this tool, you can work your way backward through analytical puzzles, propose various solutions, and find out how they affect variables.

quickly by creating styles and attaching them to new ranges.

Need graphics? You can create a variety of charts—from pies to bars to mixed line-and-bar graphs—and even add 3-D effects. A gallery of chart styles, similar to *Excel's*, helps you choose the best graph for your data. A separate module (with an interface similar to Lotus's *Freelance*) enables you to add lines, arrows, and text to worksheets and charts.

Which 1-2-3 for You?

If you've already upgraded to 1-2-3 3.1+ or even 2.3, switching to 1-2-3/W may seem unnecessary. After all, the lion's share of 1-2-3 for Windows' features—including graphics, scalable fonts, and continuous page preview—have already appeared in 3.1+ and 2.3.

No matter. If you have the hardware to handle *Windows* (a 386SX or better), switching to 1-2-3 for Windows is definitely worthwhile. The DOS versions of 1-2-3 have many of the same features, but after years of revisions, the old interface is beginning to collapse under its own weight. Even WYSIWYG releases 2.3 and 3.1—lacking scroll bars, radio buttons, and other conven-

nient tools—are far less elegant than 1-2-3/W. 1-2-3 for Windows superbly illustrates the principle that features alone don't make an excellent program—it's how easy those features are to use.

Easy access to spreadsheet power isn't the only benefit. Once you learn 1-2-3 for Windows, you'll find learning other hot Windows applications like *Ami Pro* or *Word for Windows* much more intuitive. You'll also benefit from easy font manipulation, superb printer support, multitasking, and automatic data transfers between Windows applications that use DDE.

If you're still wary of taking the Windows plunge, remember that 1-2-3 for Windows won't immerse you in a sea of pulldown menus and radio buttons before you're ready. Just hit that slash key, and you're back on familiar ground.

One-on-One with Excel

1-2-3 for Windows is a step ahead of the DOS 1-2-3s, but what about its new Windows rival, *Excel*? Both packages target the same broad audience—including management users and high-end analysts and developers.

Despite 1-2-3/W's innovative icon palette, its interface can't quite match *Excel's* smooth, intuitive personality. For example, with *Excel 3.0*, you can double-click on almost any worksheet element—a formula, say, or a graph item—and the dialog box that controls it appears, ready to edit. With 1-2-3/W—and every other program in existence—you must go to an icon or menu to open the box.

But mostly it's a lot of little things *Excel* does that make the difference. For example, 1-2-3 for Windows lacks *Excel's* ability to let you preselect a group of columns and set their width with the mouse. And it can't consolidate multiple worksheets automatically or save them as a group. All these niceties add up to increased productivity.

That Ol' Slash-Key Religion

But ultimately, many 1-2-3 users making the inevitable switch to Windows couldn't care less how good *Excel* is. It

doesn't offer 1-2-3/W's slash-key training wheels; end of story. For these people, the optional Classic menu box will be worth more than all *Excel's* shortcuts.

Where does that leave 3.1+? With hardware requirements almost as high as 1-2-3/W's—and a similar feature set—it provides little reason to keep power users from moving on to Windows' smoother interface. Release 3.1+'s only advantage is a small potential speed advantage over 1-2-3/W. Release 2.3, on the other hand, seems a good alternative—along with *Quattro Pro*—for users without the hardware to handle Windows.

1-2-3 for Windows is a major step forward for 1-2-3 users. Soon, 1-2-3 for Windows will replace Solitaire as the mission-critical application for thousands of new Windows converts. ☺

Richard Scoville is a contributing editor for PC World.

POWER TIP NO. 197

Fine-Tuning Crosstalk's VT100 Emulation

When communicating with a VAX host using VT100 terminal emulation, you'll find that Crosstalk's remapping of the PC's keyboard is somewhat flawed. VT100 users normally press <Backspace> to send a delete character and <Ctrl>-<Backspace> to send a backspace character. But Crosstalk's emulator maps these keys in just the opposite way.

You can easily reverse these key assignments and set Crosstalk straight. At Crosstalk's command line, type FK 1 ^H, press <Enter>, type save, and press <Enter>. When prompted, type the name of the XTK parameter file for the system you'll be calling.

Judy Heim
Contributing Editor

THE PC TITANS HAVE DECLARED WAR...



 **GATEWAY2000**
"You've got a friend in the business."

YET THE CHAMPION OF THE AND THE BEST VALU



nce upon a time, you had to spend a king's ransom. In those days there lived a young rebel who defied tyranny. He gathered about him a band of renegades that sold the same quality technology directly to the company was called Gateway 2000.

Over the years the people grew to love Gateway's computers and they built, sold and serviced them – so much so that the PC Titans felt threatened. A troop of outrageous mavericks, the Mighty Titans declared war on Gateway. They made much ado about rolling heads and slashing prices in a fierce battle

PEOPLE IS GATEWAY 2000 — WE SHALL PREVAIL!



to possess a personal computer.
ed himself to opposing this
es and fashioned a company
e people at a fair price. That

the merry men and women who
inch. Not to be outwitted by
e forest people. They made
market share, even though their

crusade resulted in a paltry savings.

The battle rages today. But you know how the story ends. The Titans, having grown to lumbering proportions, are no match for the swift, lean woodsmen. The best value shall prevail. When it comes to price, quality and service, the arrow that flies straight and true belongs to Gateway 2000, the legendary Champion of the People.

So buy a
Gateway and
live happily
ever after.



"You've got a friend in the business."

GATEWAY 2000 SYSTEMS

16MHZ 286 VGA

- ☞ 80286 Processor
- ☞ 2 MB RAM
- ☞ 1.2 MB 5.25" Drive
- ☞ 1.44 MB 3.5" Drive
- ☞ 40 MB 17ms IDE Drive with 32K Cache
- ☞ 16-Bit VGA with 512K
- ☞ 14" Crystal Scan 1024 Color VGA Monitor
- ☞ 1 Parallel/2 Serial Ports
- ☞ 1 PS/2 Mouse Port
- ☞ 124 Key AnyKey™ Keyboard
- ☞ New MS DOS™ 5.0

\$1395

16MHZ 386SX VGA

- ☞ Intel™ 80386SX Processor
- ☞ 2 MB RAM
- ☞ 1.2 MB 5.25" Drive
- ☞ 1.44 MB 3.5" Drive
- ☞ 40 MB 17ms IDE Drive with 32K Cache
- ☞ 16-Bit VGA with 512K
- ☞ 14" Crystal Scan 1024 Color VGA Monitor
- ☞ 1 Parallel/2 Serial Ports
- ☞ 1 PS/2 Mouse Port
- ☞ 124 Key AnyKey Keyboard
- ☞ Microsoft™ Mouse
- ☞ New MS DOS 5.0
- ☞ MS Windows™ 3.0

\$1495

20MHZ 386SX CACHE

- ☞ Intel 80386SX Processor
- ☞ 32K Cache RAM
- ☞ 4 MB RAM
- ☞ 1.2 MB 5.25" Drive
- ☞ 1.44 MB 3.5" Drive
- ☞ 80 MB 17ms IDE Drive with 32K Cache
- ☞ 16-Bit VGA with 512K
- ☞ 14" Crystal Scan 1024 Color VGA Monitor
- ☞ 1 Parallel/2 Serial Ports
- ☞ 1 PS/2 Mouse Port
- ☞ 124 Key AnyKey Keyboard
- ☞ Microsoft Mouse
- ☞ New MS DOS 5.0
- ☞ MS Windows 3.0

\$1895

25MHZ 386 VGA

- ☞ Intel 80386 Processor
- ☞ 4 MB RAM
- ☞ 1.2 MB 5.25" Drive
- ☞ 1.44 MB 3.5" Drive
- ☞ 80 MB 17ms IDE Drive with 32K Cache
- ☞ 16-Bit VGA with 1 MB
- ☞ 14" Crystal Scan 1024NI Color VGA Monitor
- ☞ 1 Parallel/2 Serial Ports
- ☞ 124 Key AnyKey Keyboard
- ☞ Microsoft Mouse
- ☞ New MS DOS 5.0
- ☞ MS Windows 3.0

\$2095

BEST BUYS

- ☞ Get our 33 MHz 386 Cache system, same configuration as listed, with a 120 MB IDE hard drive instead of the 200 MB drive.

\$2495

- ☞ Same features as our 33 MHz 486 Cache system except this machine has 4 MB RAM, instead of 8, and a 120 MB IDE hard drive, instead of the 200 MB drive in our standard configuration.

\$2845

33MHZ 386 CACHE

- ☞ Intel 80386 Processor
- ☞ 64K Cache RAM
- ☞ 4 MB RAM
- ☞ 1.2 MB 5.25" Drive
- ☞ 1.44 MB 3.5" Drive
- ☞ 200 MB 15ms IDE Drive with 64K Multi-Segmented Cache
- ☞ 16-Bit VGA with 1 MB
- ☞ 14" Crystal Scan 1024NI Color VGA Monitor
- ☞ 1 Parallel/2 Serial Ports
- ☞ 124 Key AnyKey Keyboard
- ☞ Microsoft Mouse
- ☞ New MS DOS 5.0
- ☞ MS Windows 3.0

\$2795

25MHZ 486 CACHE

- ☞ Intel 80486 Processor
- ☞ 64K Cache RAM
- ☞ 4 MB RAM
- ☞ 1.2 MB 5.25" Drive
- ☞ 1.44 MB 3.5" Drive
- ☞ 200 MB 15ms IDE Drive with 64K Multi-Segmented Cache
- ☞ 16-Bit VGA with 1 MB
- ☞ 14" Crystal Scan 1024NI Color VGA Monitor
- ☞ 1 Parallel/2 Serial Ports
- ☞ 124 Key AnyKey Keyboard
- ☞ Microsoft Mouse
- ☞ New MS DOS 5.0
- ☞ MS Windows 3.0

\$2995

33MHZ 486 CACHE

- ☞ Intel 80486 Processor
- ☞ 64K Cache RAM
- ☞ 8 MB RAM, Expands to 64 MB
- ☞ 1.2 MB 5.25" Drive
- ☞ 1.44 MB 3.5" Drive
- ☞ 200 MB 15ms IDE Drive with 64K Multi-Segmented Cache
- ☞ 16-Bit VGA with 1 MB
- ☞ 14" Crystal Scan 1024NI Color VGA Monitor
- ☞ 1 Parallel/2 Serial Ports
- ☞ 124 Key AnyKey Keyboard
- ☞ Microsoft Mouse
- ☞ New MS DOS 5.0
- ☞ MS Windows 3.0

\$3395



The Extras – That Don't Cost Extra At Gateway

- 30-day money-back guarantee
- One-year warranty on parts and labor
- Free bulletin board technical support
- Toll-free technical support for the life of the machine
- Custom 124-key programmable AnyKey keyboard standard with all systems
- Free on-site service to most locations in the nation
- Replacement parts sent via overnight shipping free of charge
- Leasing options for commercial customers
- Non-interlaced color monitors standard with all 386 DX and 486 systems

Due to the volatility of the DRAM market, all prices are subject to change. Prices do not include shipping.

Sales Hours: 7am-10pm Weekdays, 9am-4pm Saturdays (CST)

New Expanded Service Hours: 6am-Midnight Weekdays, 9am-2pm Saturdays (CST)



8 0 0 - 5 2 3 - 2 0 0 0
610 Gateway Drive • N. Sioux City, SD 57049 • 605-232-2000 • Fax 605-232-2023

AnyKey, Intel, Microsoft, MS DOS and Windows are trademarks or registered trademarks of their respective companies. © 1991 Gateway 2000, Inc.



Ami Pro 2.0: Lookin' Good

Looking snazzier than ever with its push-button interface and versatile icon bar, Ami Pro 2.0 meets Word for Windows head-on in power features.

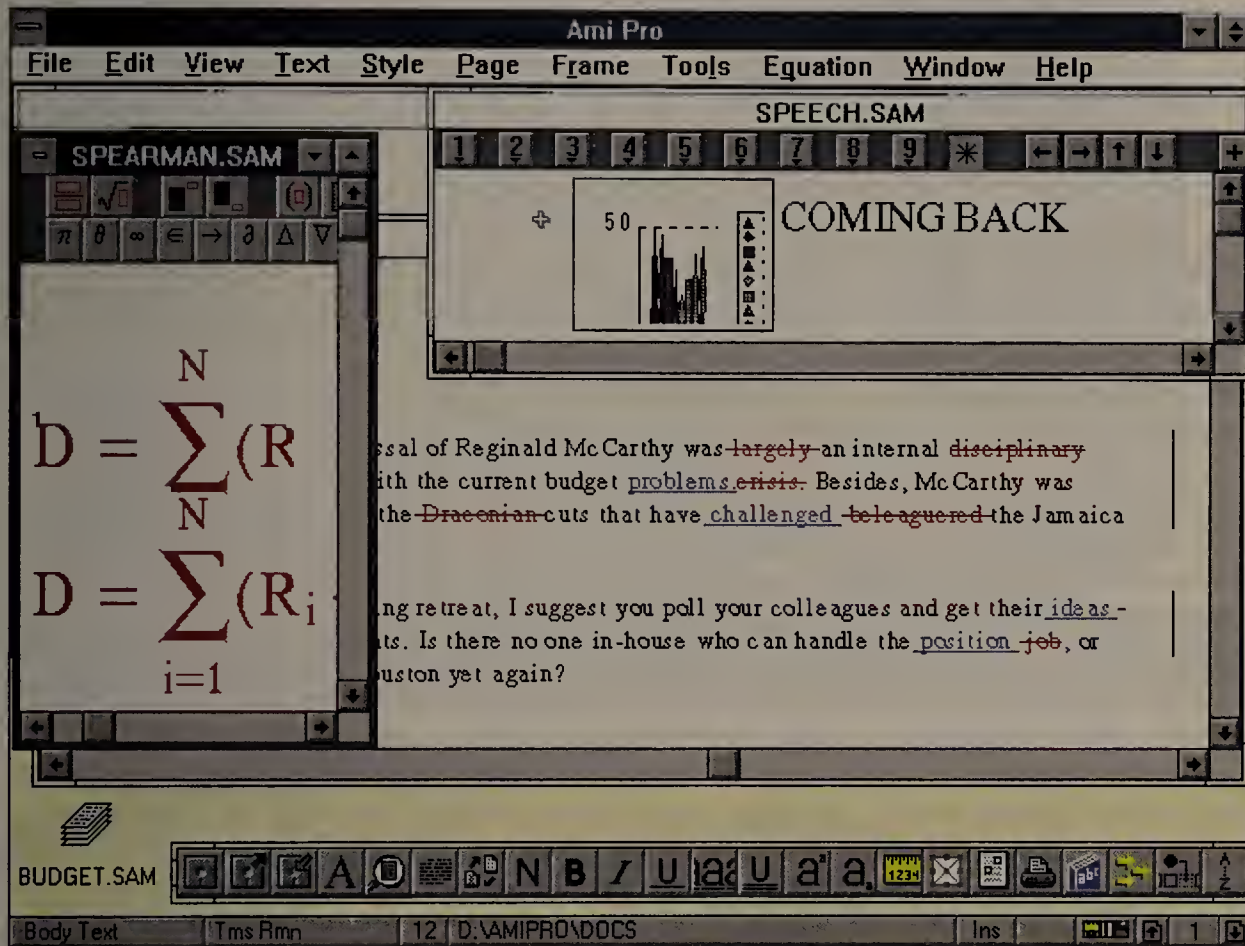

Ami Pro 2.0 lets you juggle several documents at once. Hot new features include a high-powered equation editor, a redliner for marking suggested additions and deletions, and an outliner.

Eric Brown

If it's true that looking good is the essence of feeling good, then the users of *Ami Pro 2.0* will be a very happy lot indeed. Version 2.0 of this *Windows* word processor revamps its interface to stunning effect with pull-up windows, 3-D buttons, and a versatile new icon palette that's so hot Lotus is adding it to *1-2-3 for Windows* and *Freelance for Windows*.

But the new *Ami Pro* offering is more than just pretty icons and friendly dialog boxes. Version 2.0 adds all the high-end tools that have given rival *Word for Windows* the edge among corporate users. In addition to improving the

superb charting and drawing tools that made version 1.2 such a standout, Lotus has upgraded *Ami Pro* with an outliner, a redliner, and automation tools that are similar to *Word for Windows*' automated templates.

Taking Icons to a New Level

For many users, *Ami Pro 1.2* looked a bit too much like a paint program—they preferred the more corporate look of *Word for Windows*' sculpted ribbon bar. A smattering of design details lends the new *Ami Pro* a more professional look, but *Ami Pro*'s festive nature lives on with the enhanced color controls offered in this latest version.

Each icon is smaller, so you

can fit more icons along any side of the screen. You can also float any number of icons freely in a box of any shape. Icons and buttons now sport the 3-D push-button effect popularized by *Excel 3.0*. Previously, you could set up macros as bare-bones buttons, but now you can also create custom macro icons, importing any metafile or BMP file to be the picture. The images scale to size automatically.

Even *Ami Pro*'s styles are more stylish. You can now select paragraph styles and font sizes from *Excel*-like pull-up menus that open from the bottom status line. This approach is more convenient than the floating styles box, which obscured the screen. Some other

good news—you can now create styles by example—basing a style on previously formatted text. And because Lotus will bundle a copy of *Adobe Type Manager*, all your fonts will look sharp.

If you work with several documents at once, you'll appreciate the improved windowing. Version 1.2 let you open multiple windows, but the process was awkward, and a new menu bar in each window ate up real estate. Now you can open and resize windows easily, with a minimum of screen overhead, and cut and paste freely. You can even minimize documents into icons that sit at the bottom of the screen.

Other changes are less spectacular but add up to

SNAPSHOT

Ami Pro 2.0

WINDOWS An elegant interface raises this *Windows* word processor to a new level of ease, but the big story for corporate buyers is its powerhouse features.

KEY FEATURES

- Customizable icon palette
- Outliner
- Group editing features
- Improved windowing
- Power fields for automated documents
- Equation editor

AVAILABILITY

August 1991

PRICING

\$495, upgrade \$49.95 if previous version purchased in last six months; other upgrade prices unavailable at press time

Lotus Development Corp.

Word Processing Division
5600 Glenridge Dr.
Atlanta, GA 30342
800/831-9679,
404/303-7624 (fax)

Reader service no. 747

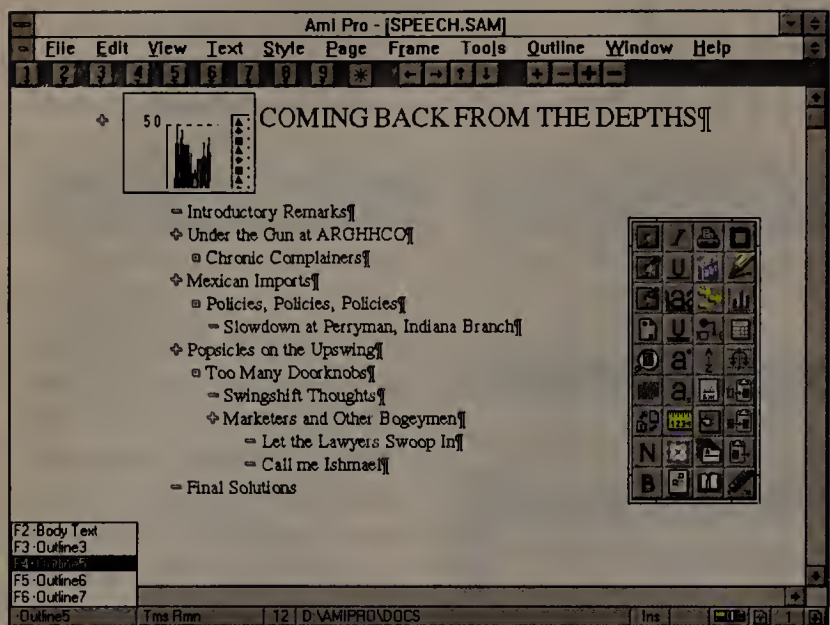

You can freely change the size and location of Ami Pro's new icon palette. Here it floats above an outline generated with the new outliner. The outliner is based on styles, which you now select from a pull-up menu on the bottom status line.

heightened convenience. An interactive tab ruler includes tab icons, so you can designate a right-justified tab without working your way through a dialog box. Like Symantec's *JustWrite*, *Ami Pro* recognizes and converts alien file formats on the fly when importing documents. And like *Word for Windows*, *Ami Pro* displays the names of the last several documents opened on the File menu.

Outline for Success

Ami Pro devotees had to wait a long time for an outliner, but now they've got a good one. This fully integrated outliner lets you expand and collapse nine levels of headings by clicking on an icon bar along the top. As with *Word for Windows*' outliner, you can integrate and hide text and copy hidden text simply by copying the heading.

Another catch-up to *Word for Windows* is the addition of group editing features. *Ami Pro*'s redliner marks suggested deletions and additions in a specified color or attribute, and you can accept or delete edits individually. If your editor failed to use the redline feature when finessing your document, you can resort to a

Compare feature that compares two versions of a document to create edit marks automatically in the current version.

Lotus has upgraded the table editor with multipage features. In a text table format, if you have rows with more than one line, you can now break pages between lines. Previously, you could end up with a blank space on the bottom of a page because *Ami Pro* forced the entire multiline row onto the next page. You can also easily repeat the headings along the top of each page.

Additionally, *Ami Pro* has improved long-document features, offering a master-document function similar to the one in *Ventura Publisher*: You can keep "chapters" in separate files yet treat all the files in a tagged group as a single document. To update page numbers, you run one update instead of processing each chapter file separately.

Scientists and technical users should be happy with the equation editor, which is based on the Tex mathematical typesetting language. You build and manipulate equations by selecting icons on the main editing screen rather than in a separate editor.

Grabbing Greater Graphics

Ami Pro's already capable charting and drawing features are getting downright sophisticated—enough to steal some sales from low-end desktop publishing packages or maybe even from Lotus's *Freelance*. Frames have always been fundamental to *Ami Pro*'s success with graphics—all text and graphic elements reside in these discrete holding areas, making it easy to manipulate them without affecting surrounding text. But now the frames don't have to be boring old rectangles—you can add rounded corners, create oval frames, apply automatic shadows, or shade them with any color. Additionally, you can place clip art in text and watch the text wrap while you edit.

In the old charting module, the miniature example chart in the dialog box was a dummy. Now it's live so you can manipulate it directly, avoiding lengthy screen refreshes and keeping you closer to the controls. Like the latest charting packages, *Ami Pro* offers 16 color schemes, and you can now chart negative data values and manually adjust chart perspective.

Lotus has also upgraded the drawing module. You can draw lines and arrows directly on a chart, draw freehand, sketch Bézier curves, and manually rotate both images and text in any direction without a dialog box detour. *Ami Pro* now ships with over 100 clip-art symbols instead of the previous handful. Not only can you save objects as BMP files and metafiles, you can completely edit a clip-art graphic after you've imported it.

At Play in the Fields of Power

Ami Pro's new *power fields* appear to do everything *Word for Windows*' automated templates do—more if you combine them with macros. Power fields are essentially variables

that you place within cross-reference marks embedded in the text. Power fields can also analyze other variables, sort of like conditional mail merge within your main document. For example, you can use a power field for numbering charts in sequence—it can automatically check to see what page a chart is on, determine its position relative to the other charts, then number it accordingly.

You gain further dexterity when you combine a power field with a macro. An IF...THEN statement connected to a power field in the text could check a sales figure from a table, perform a calculation, select from a list of phrases, and finally insert the words "encouraging results."

Advanced users can link power fields to macros to create intelligent forms that respond with pick lists, generate contact management systems, or develop hypertext doorways that sling you into other documents via Dynamic Data Exchange (DDE) links. As with *Word for Windows*, you can create stock templates of these power fields, saving them as style sheets.

Finally, the macros themselves are more versatile. Unlike with *Word for Windows*, you can attach macros directly to framed images, so clicking on a picture brings up additional information.

At least until the new version of *Word for Windows* comes out this fall, *Ami Pro* will reign as the premier *Windows* word processor. It's still somewhat easier to apply formats and manipulate graphics in *Ami Pro* than in Microsoft's baby, and *Ami Pro* is no longer missing major checklist items. It also carries the Lotus label, which should give buyers a sense of security. ●

Eric Brown is a senior editor for PC World.

INTRODUCING THE EVER HAPPENED



BEST THING THAT TO WINDOWS.

THE NORTON DESKTOP FOR WINDOWS.

Now you can make Windows perform the way you've always wanted—without changing the way you use it. For just \$149,* The Norton Desktop includes an impressive collection of Peter Norton's best programs that make Windows more accessible and a whole lot easier to use.

For starters, you can move your programs and file groups from the confinement of the Windows Program Manager to the freedom of The Norton Desktop—it's like having your file manager and program manager transparently integrated!

The Norton Desktop's enhanced file manager allows you to launch, copy, move, view and delete a

file or application by clicking and dragging icons on the desktop. You can also print documents by dragging files to any printer icon. In fact, our icon editor makes it easy to select any of the more than 150 icons provided, while The Norton Viewer enables you to instantly

view files from over 30 Windows and DOS applications.

Not only does The Norton Desktop make sure that your files are well managed, it also ensures they're well protected.

We've included The Norton Backup™ for Windows,** the fastest, most reliable Windows backup you can buy. You can easily set-up automatic backups for any time of the day or night, whether you're present or not, and backup in the background, even to and from network drives.

The Norton Desktop also provides the easiest UnErase™ ever, for stand-alone PCs and network systems, plus the industry's most powerful automatic disk diagnosis/repair.

The program has a host of additional features, including a rich assortment of colorful screen savers, along with our SuperFind™ text searching, which enables you to search and find files quickly and easily on any disk drive—even on networks.

So if you're ready to improve your Windows, call 1-800-343-4714, Ext. 722W for more information about The Norton Desktop. Or visit your nearest dealer and pick up a copy for yourself. It could be the best thing that ever happened to your PC.

UnErase



The Norton Desktop integrates a file manager and program manager into one seamless desktop.



Norton Backup



SYMANTEC.

*Suggested retail price, USA only. **Also available separately for \$129 (MSRP). © 1991 Symantec Corporation. All rights reserved. The Norton Desktop for Windows is a trademark of Symantec Corporation. All other brand or product names mentioned are trademarks of their respective holders.

Broadcast Video On Your PC Starts With The Right Connection.

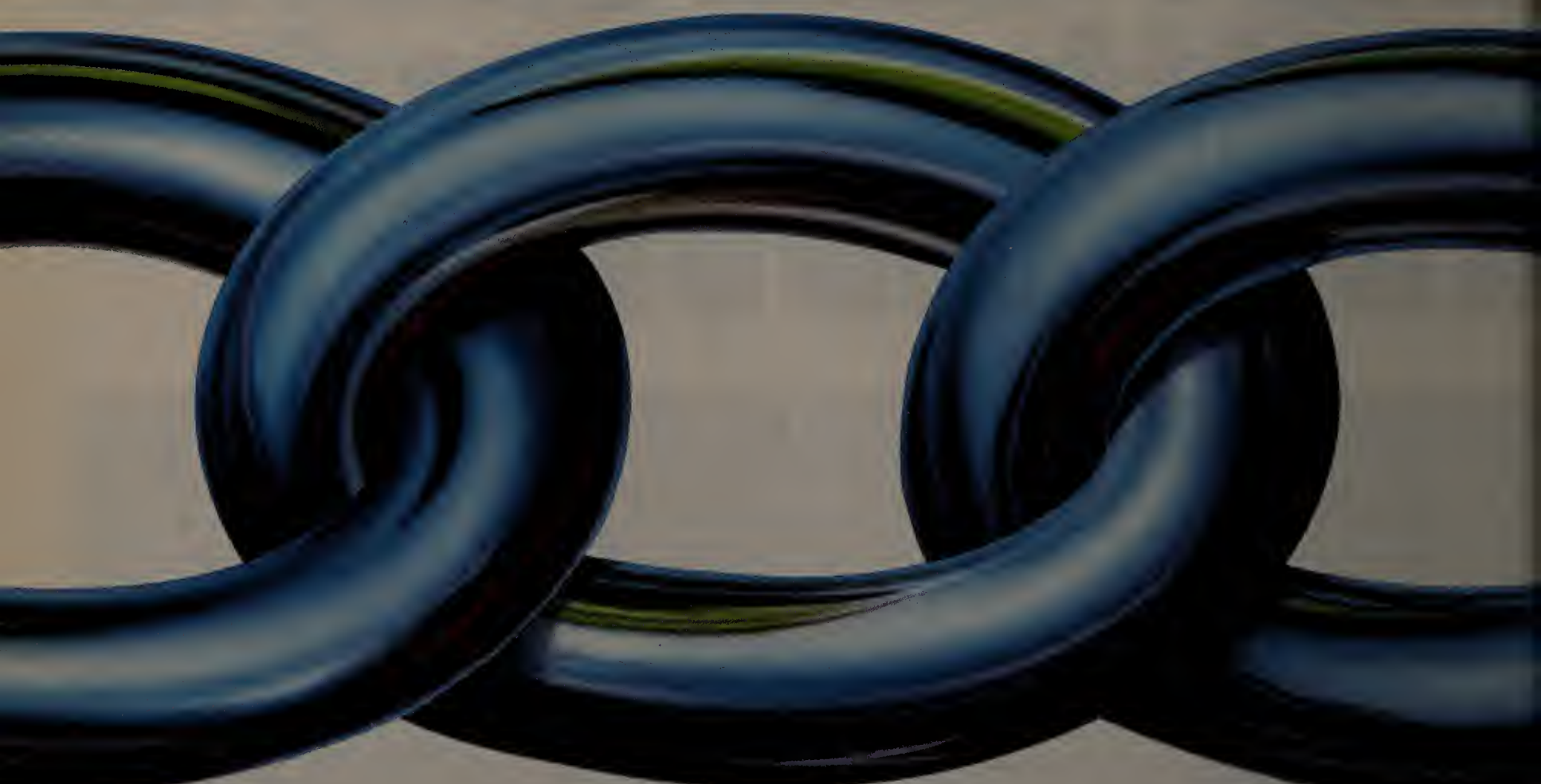

VideoLinx: FrameBuffer. \$695.

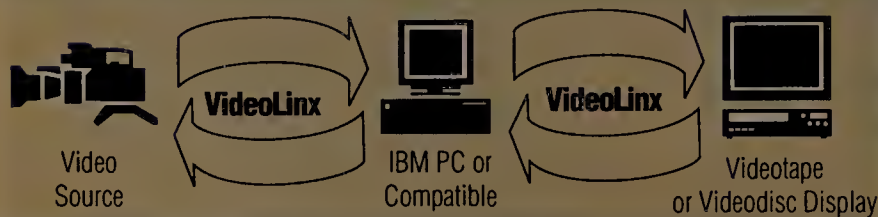

VideoLinx and your PC have joined forces to put the technology of television stations on your desktop. At a price you won't believe.

Just imagine—from any video source, TV, VCR, Camcorder, still camera, or LaserDisc, you can *capture*, *process*, and even *display* beautiful, full fidelity NTSC video images. Never again will you be limited to VGA quality. With up to 16.8 million colors, full overscan, and 746 X 484 resolution, you will marvel at the clarity on the screen.

Delight in the flexibility. With a choice of file formats, including TIF, GIF, PCX, TARGA, and others, you can modify the pictures using your favorite paint programs and still get broadcast-quality images. At one-third the price of any other PC board with comparable quality and features, VideoLinx is an outstanding value.

VideoLinx's picture-perfect capabilities bring a new level of performance to animations. Add a frame-accurate video recorder and animation software to create sequences with an expensive, on-the-air look. For desktop publishing, VideoLinx images will make a world of difference in your final product.

Make the VideoLinx connection today. It's truly the PC-TV link that's been missing for presentation professionals at all levels. Perfect image in, perfect image out. Pass after pass. And, it's only \$695.

Call, fax, or write Brown-Wagh Publishing to learn more. 800-451-0900 (outside Calif.), 408-378-3838 (inside Calif.), 408-378-3577 (fax).

*Brown
Wagh*



All reference products are registered trademarks of their intended companies.

Brown-Wagh Publishing, 130-D Knowles Drive, Los Gatos, California, 95030

Circle 87 on reader service card

One-Stop Windows Shop

PFS:WindowWorks, the first Windows integrated package, can save new users time and money.

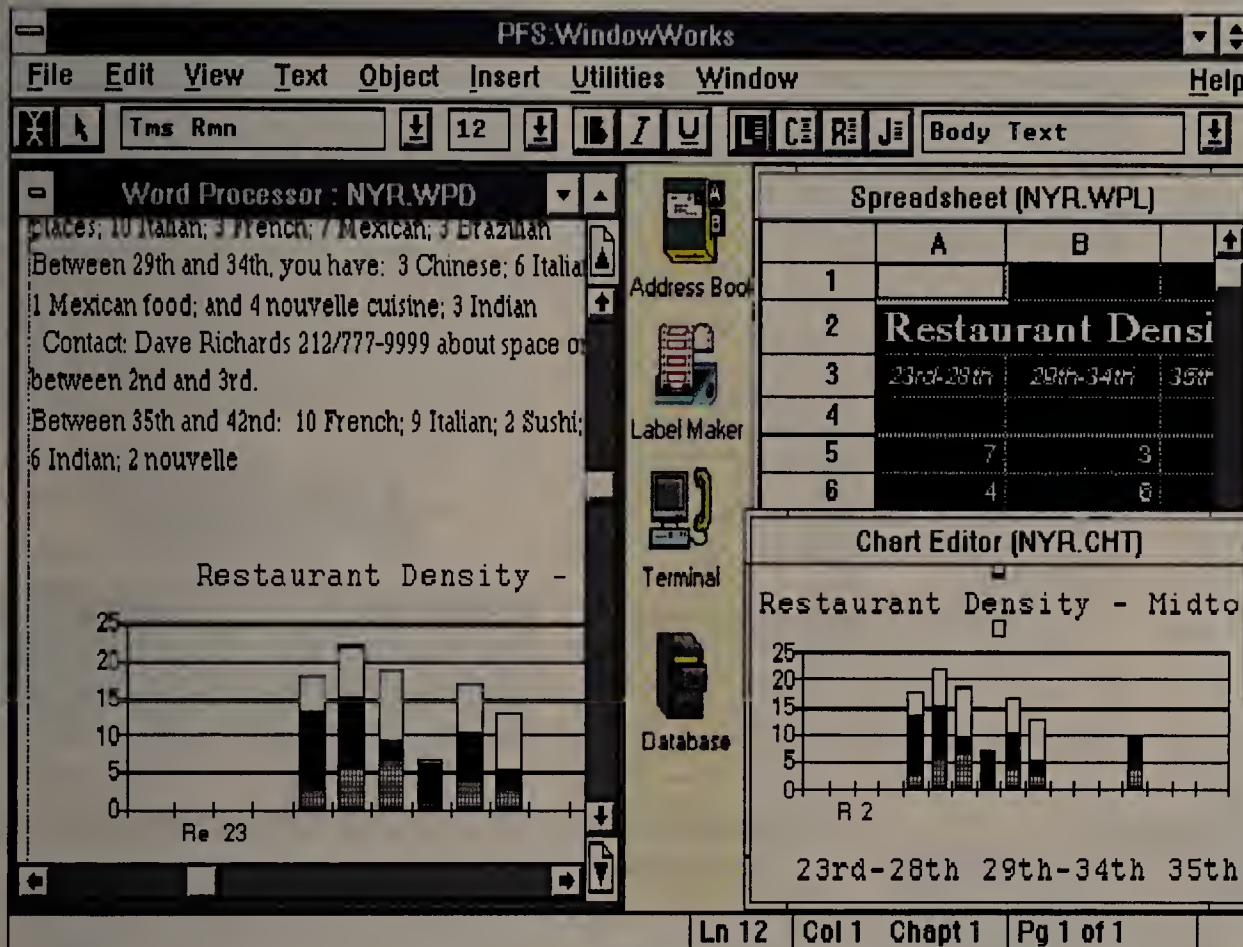

PFS:WindowWorks' tightly integrated modules make it easy to create high-quality documents.

Susan Lusty

You just acquired *Windows*, but you don't want to spend dollars or disk space on multiple stand-alone programs. Spinnaker Software, which recently bought Software Publishing's integrated packages, has been thinking about you. Its *PFS:WindowWorks* gives owners of small businesses, portables users, and others easy entry into the *Windows* world by integrating a word processor, a spreadsheet, a chart editor, a communications terminal, a data base manager, an address book, and a label maker in one package.

Seven Easy Pieces

The word processor—the most used module in any integrated package—is *Window-*

Works' strongest feature. It tops a very capable set of word processor features with entry-level desktop publishing abilities such as manual kerning, line drawing, and text wrapping. Spinnaker throws in Atech's on-the-fly font generator, *Publisher's Powerpak*, which comes with three WYSIWYG fonts to make creating newsletters or presentations easier at print time.

For number crunchers, Spinnaker's spreadsheet provides ample features. It offers 40 basic mathematical, statistical, and financial functions and imports 1-2-3 WK1 and WKS files. To see a spreadsheet in graph form, simply cut and paste to the chart editor, where you can view your profits in nine chart styles. If you change the spreadsheet,

the chart editor updates its graph, thanks to *WindowWorks*' "hot links." If you dropped the graph into the word processing document, it's updated there too.

Unlike many integrated packages' communications modules, *WindowWorks*' is more than minimal. It supports the XMODEM and YMODEM protocols, and you can save log-on sequences using its scripting language.

A dBASE-compatible data base manager stores 32,000 records, and you can generate ten reports per data base. The package includes an address book and a label maker, which work with the data base for mass mailings and mergings.

Intuitive Integration

How does *Windows* aid *Win-*

dowWorks? You'll find desktop publishing enhancements; *WindowWorks*' menus are more consistent than its DOS predecessors'; and you needn't close or minimize one module before opening another. You also can share your work via the Clipboard with other *Windows* packages, such as *Excel*, although DDE links aren't supported.

WindowWorks takes up 2MB on your hard disk, and you may like its performance on less than a 386SX with 2MB of memory. But if you're moving to *Windows* and lack the budget or time to tackle full-blown applications right away—or if you simply want a taste of *Windows* applications—*WindowWorks* should do the trick. ☺

Susan Lusty is an assistant editor for PC World.

SNAPSHOT

PFS:WindowWorks

WINDOWS Spinnaker's integrated *Windows* package offers a grab bag of tools and tighter integration than stand-alone DOS and *Windows* rivals.

KEY FEATURES

- Hot links update data between modules
- Capable word processor with low-end desktop publishing functions
- Bundled WYSIWYG fonts
- Imports WKS, WK1, TIFF, PCX, DBF, DIF and other standard files

AVAILABILITY

Immediate

PRICING

\$199

Spinnaker Software

201 Broadway
Cambridge, MA 02139
617/494-1200,
617/494-1219 (fax)

Reader service no. 744

The Intelligent Road Atlas For Your PC!

Planning a vacation? Heading out on the road on business? Now there's a system that helps you plan any road trip for fastest, prettiest or most convenient route — with hundreds of up-to-date, color maps right on your computer screen.

Clear, detailed maps that can get you anywhere in the United States that you want to go. Just tell AutoMap where you're going, when and where you'll be starting from, what areas you'd like to avoid, what areas you'd like to visit on the way and how you like to drive. It's fast, fun and informative.

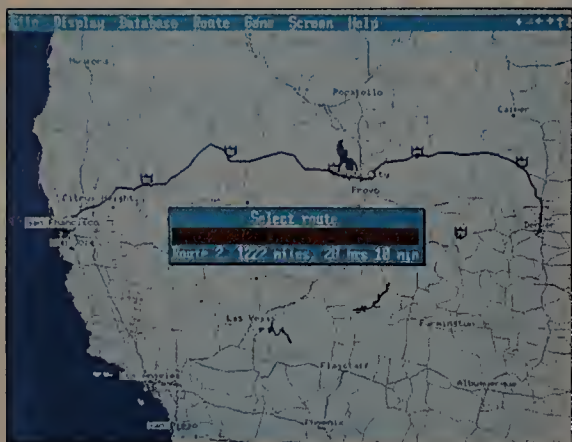

Just select your starting point, end destination, and areas to visit and let AutoMap create a detailed map of your next trip!

AutoMap's powerful intelligence takes over from there. Instantly, it searches its massive database of over 300,000 miles of roads and highways for the best route to meet your requirements. It even gives you a list of alternative routes if you decide you'd like to wander a bit. AutoMap also gives you a list of "places" from over 50,000 in its database. It's like having a travel guide pointing out the very best there

is to see and do. If you're a business traveller, you won't have to worry about being unfamiliar with new territories — just a quick session with AutoMap and you'll know exactly where you're going.

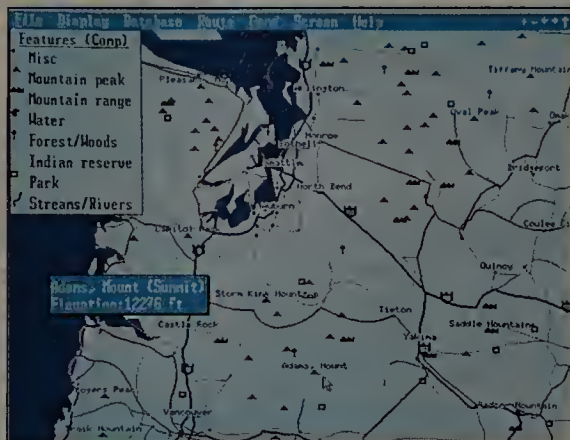

AutoMap's driving instructions tell you which roads to travel, how far to go, and approximate traveling time.

AutoMap allows you to view your entire journey as a full color map and gives you all the details on mileage. Zoom out to see the entire region, or zoom in to see every detail. AutoMap's driving instructions list all the roads you'll be traveling, exactly how far to go, exactly where to turn and even the signs to look for! These maps and directions can be viewed on your screen and printed out to refer to as you need them.

Government Highway Data.

AutoMap uses data with the renowned accuracy of government sources. It has been designed to remain accurate with constant updates of new maps and details as they become available. AutoMap has



proven itself with the most demanding businesspeople and vacationers. It's helpful and convenient, but more importantly, AutoMap will save time, money and frustration. In fact, surveys show that AutoMap can easily save up to 20% in driving time and related costs. There's even a built-in quiz to test your knowledge of geography.

AUTOMAP
INCORPORATED

AUTOMAP

RQ4098-5 AutoMap 5 1/2" \$99.95
RQ4098-3 AutoMap 3 1/2" \$99.95
Hercules, CGA, EGA, VGA, 512K RAM, hard disk, mouse recommended.

The Ultimate Word Processor For Windows!

More than word processing, more than desktop publishing, Ami Pro makes the best use of the powerful WYSIWYG environment and brings your documents to a new level of sophistication — and ironically, we found it much easier to use than Microsoft Word for Windows. Ami Pro's extremely intuitive nature makes it fast and fun to use.

View your documents as you edit them, including all text, headers, footers and footnotes. Use Ami Pro's "frames" (which can contain text for page-within-page formats) to pick-up-and-place graphics easily and position them precisely within the page. You'll see it right on-screen.

Enjoy features they can't find anywhere else, like tables that allow you to perform math, automatically create charts and graphs (easily import data for charts from spreadsheets with 12 styles to choose from), draw, employ its Dynamic Data Exchange capabilities with other Windows applications and even create documents using its powerful style sheets.

Ami Pro includes a set of style guides that you can use to quickly put together ads, multi-column newsletters, brochures, letters, reports, presentations and even your everyday correspondence.

With Ami Pro's graphics handling



features (using its "frames" described above), inserting graphics is just a mouse-click away — with exact positioning. See it as you work!

EXCLUSIVE TIGER PACK
AMI PRO
PLUS WINDOWS 3.0 &
THE LOGITECH MOUSE
ALL JUST \$169!

Lotus®

Ami Pro

RQ5090 Ami Pro Competitive Upgrade

5 1/4" & 3 1/2" \$119.95

RQ5095 Tiger Pack: Ami Pro Competitive

Upgrade, Logitech Mouse and

Microsoft Windows 3.0;

5 1/4" & 3 1/2" \$169.95

Sorry, free shipping is not included on this special offer.

Corel Draw! + NEC CD = Picture Power!

Corel Draw! on CD?

That's right. Now you can get the world's best drawing program on CD. Pop in this CD and discover a truckload of exciting and powerful graphics tools. You get over 150 type-faces, over 3000 symbols and designs, a free Pantone® color license, a free copy of CorelTRACE, and more.



In addition to all the fabulous features of Corel Draw! 2.0, you get over 3500 extra professional, color clipart images! Not just your average clipart, this is from ArtRight — a leader in the art business. PC Mag recently awarded ArtRight their Editor's Choice Award after reviewing lots of clipart (including Arts & Letters).

This same clipart alone (without Corel Draw!) is still sold on diskette for \$1192 and takes up 43 diskettes. But you can have it on a single CD for a fraction of the cost. And as a bonus

-- your CD clipart is not compressed, meaning it will load up to 10 times faster than the diskette version!

NEC CD Reader

Why settle for an off-brand when you can have the best? The NEC CDR-36

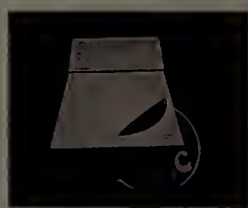

is the latest release in a long line of proven CD Readers. Tried and true, this sleek new CD Reader will welcome you into the world of CDs. You'll soon fall in love with the vast amounts of information CDs place at your fingertips. Perhaps next you'll add an entire encyclopedia on a single CD to your library — or maybe all the phone books in the U.S. (Think about the mailing and telemarketing possibilities!)

COREL

Corel Draw! & CDR-36

RQ8635 Corel Draw! CD-ROM &

NEC CDR-36 Reader \$999.00

RQ8673 Upgrade to

NEC CDR-73 ... Add \$399.00

RQ8630 Corel Draw!

CD-ROM only \$595.00

RQ5080 Corel Draw!

Disk Version \$399.00

Requires AT or above, hard disk, 640K, Windows 3.0, mouse.

TIGERSOFTWARE

FREE FEDERAL EXPRESS (INT'L ORDERS 305-443-8212) TO ORDER

1-800-888-4437

Circle 259 on reader service card

EXCLUSIVE
PC WORLD
OFFER!

LOTUS® AMI PRO 2.0

FREE TRIAL DISKS!

Test Drive Ami Pro™ Version 2.0 from Lotus®, the Visual Word Processor for Windows

What's on the Test Drive disks?

You'll receive a working model of *Ami Pro* version 2.0 from Lotus Development Corporation, the new word processor designed from the bottom up for *Windows*. *Ami Pro* makes creating documents easy and quick because it works the way you think—visually. You'll see the difference right from the start with the extensive palette of time-saving *Ami Pro* Smart Icon buttons. Explore further and create professional-looking business documents with the click of a mouse, using *Ami Pro* style sheets and advanced charting and drawing functions. You'll also discover how *Ami Pro* takes the guesswork out of formatting by providing interactive preview windows that instantly show changes to your document. What's more, *Ami Pro* links to the full suite of *Windows* applications from Lotus, including *1-2-3 for Windows*, so adding data is a snap.

Your *PC World* Test Drive also comes loaded with valuable additional features you won't find elsewhere, like a unique product guide and sample files that put *Ami Pro* to work for you. So hurry: Supply is limited, and demand is very high.

How do I get my disks?

It's easy. Simply complete and mail the postage-paid reply card, or call Lotus at 1-800-872-3387 ext. 1236 in the U.S., 1-800-668-1509 in Canada. Expect your disks to arrive in four to seven weeks. Remember... the supply is limited, and you won't see this offer anywhere else.

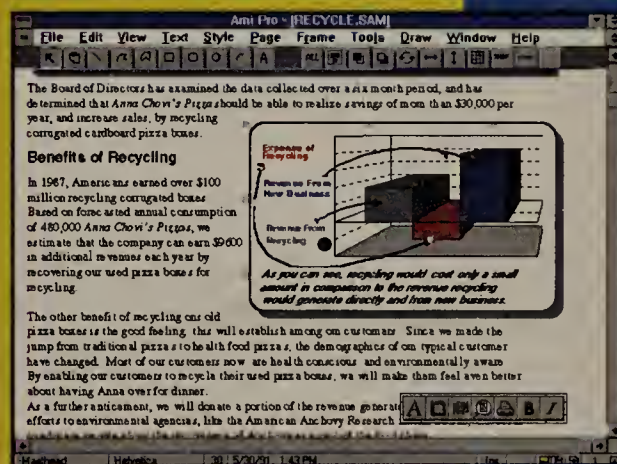
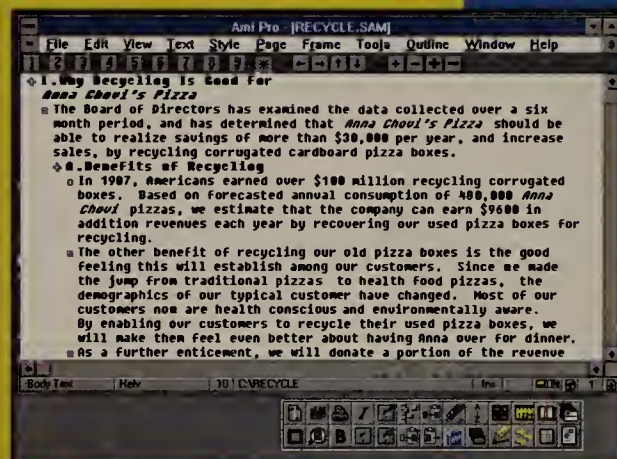

What are the system requirements?

- IBM PC AT or compatible using 80286 or higher micro-processor with 1MB of RAM
- Windows 3.0
- Hard disk
- 5¼-inch 1.2MB high-density disk drive or 3½-inch 1.44MB high-density disk drive
- EGA or higher-resolution color monitor
- Mouse

Limited-time offer! Only in PC WORLD

■ YES! I want to experience the excitement of *Ami Pro* version 2.0 from Lotus. Please send me the *PC World-Ami Pro* version 2.0 Test Drive without cost or obligation.

My disk format is (check one only):

3½" 1.44MB 5¼" 1.2MB

I currently own a word processor

yes no

NAME _____

COMPANY _____

ADDRESS _____

CITY, STATE, ZIP _____

CALL: 1-800-872-3387 EXT. 1236 in U.S.

CALL: 1-800-668-1509 in Canada

Offer good in U.S. and Canada only. One per person. Offer expires December 31, 1991. Look for more exciting trial disk offers in future issues.

FREE LOTUS® AMI PRO 2.0



This Exclusive TEST DRIVE

Brought to You by:

PC WORLD

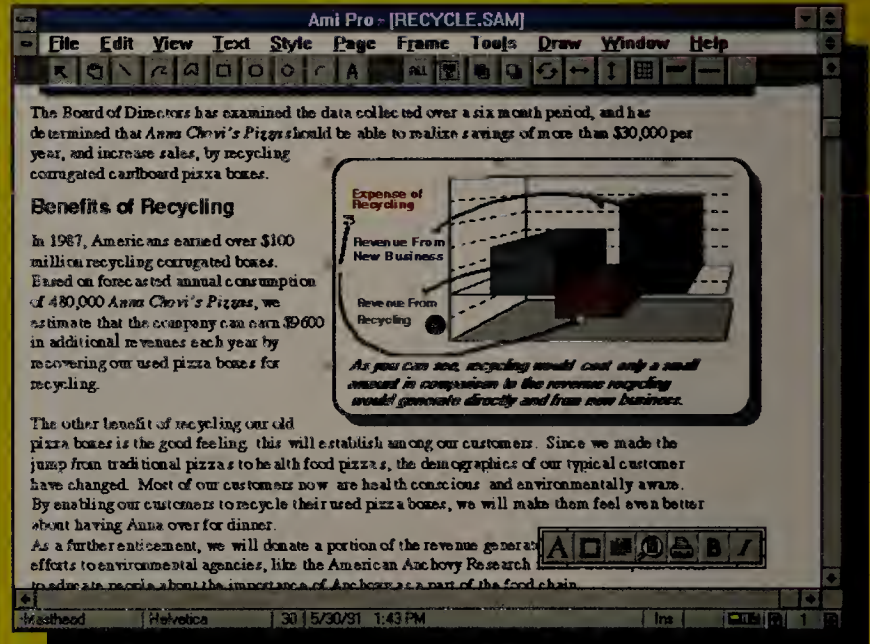
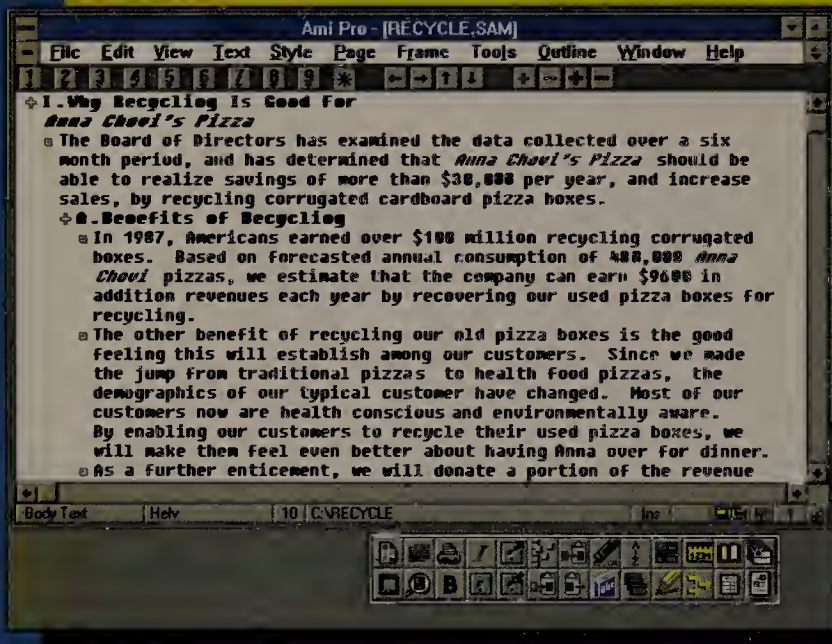

NO POSTAGE
NECESSARY
IF MAILED
IN THE
UNITED STATES

BUSINESS REPLY MAIL

First Class Mail Permit No. 1001 Peoria, IL

Postage will be paid by addressee

PC WORLD-AMI PRO 2.0 TEST DRIVE
LOTUS DEVELOPMENT CORPORATION
P.O. BOX 3900
PEORIA, IL 61612-8823

**Absolutely
free while
supply lasts.
Special to
PC World
readers.**

See Other Side for Details



Smart Like a Fox

The new FoxPro works smarter—and much quicker.

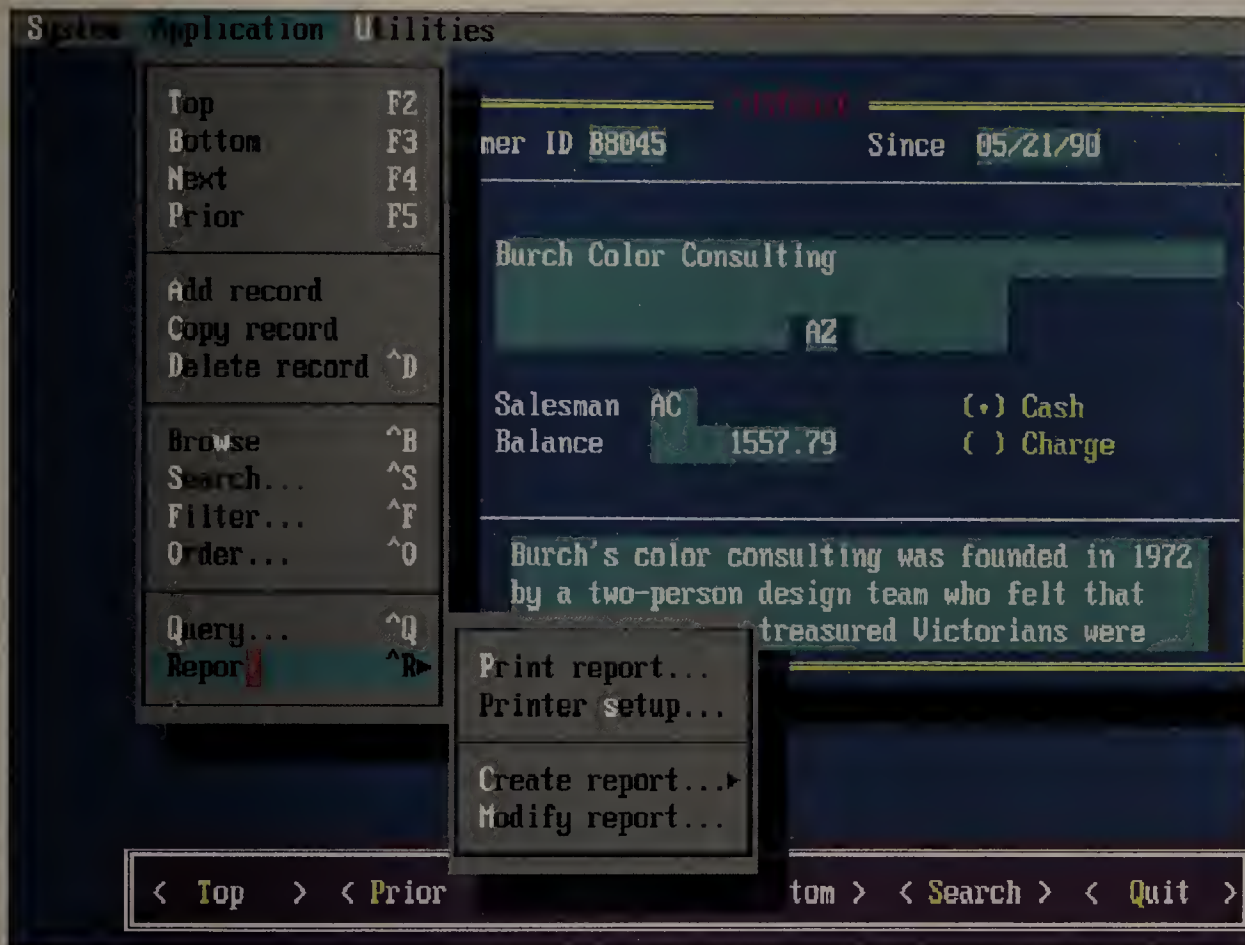

FoxPro 2.0 makes it easy to create a data entry screen—and a simple yet complete application.

Alan Schwartz

With its character-based windowing interface and benchmark-setting performance, Fox Software's *FoxPro* has built a reputation for fast, easy dBASE-compatible data management. The new *FoxPro 2.0* is even faster and easier, thanks largely to patent-pending technology—named *Rushmore*—that simplifies and speeds up searches.

Consider a simple example: listing, in alphabetical order, Arizona customers with balances of more than \$1000. With *FoxPro 1.02* or any other dBASE product, if you simply look for the data—for instance, with a command like LIST FOR State = "AZ" AND Balance > 1000—you have to wait a long time for the answer. To get results quickly, you're forced to devise some

sort of clever index-oriented strategy.

With version 2.0, *Rushmore* handles the strategy for you. The results are astonishing: In a casual test with the LIST FOR example above, *dBASE IV 1.1* took 170 seconds to pull 50 records from a 10,000-record file, *FoxPro 1.02* took 140 seconds, and a prerelease version of *FoxPro 2.0* managed it in only 4! And complex relational searches are accelerated even more.

The fields you search on must still be indexed, but that's no problem—because like *dBASE IV*, *FoxPro 2.0* keeps all of a file's indexes together and updates them automatically.

Query by Design

You'll also have an easier time setting up complex relational searches, thanks to a new que-

ry-design screen. At first glance, you may not find it as intuitive as the *Paradox* and *dBASE IV* query-by-example (QBE) screens—it doesn't look like a browse table—but the near-instant results make a terrific learning aid. Furthermore, *FoxPro's* layout puts more options and information on the screen than a conventional QBE does.

You don't have to be a programmer to create *FoxPro* applications anymore. Now you can quickly and easily construct a comprehensive program by pointing and shooting with a mouse. Some tasks, like setting up complex data validations, still require programming. One plus: *FoxPro's* agile browse windows now elegantly display one-to-many relationships.

Professional developers can now create stand-alone EXE

programs with a \$500 royalty-free distribution kit. And thanks to the new open architecture, C or assembly programmers can take *FoxPro* places that Fox Software never envisioned.

FoxPro 2.0 is a great tool for professional programmers, amateur programmers, and people who just need to get at their data easily. The program puts lightning-fast data access in the palm of your hand. ☺

Alan Schwartz is a principal in MicroMega Systems, a data base design and training firm in San Francisco.

SNAPSHOT

FoxPro 2.0

The fastest data manager around becomes easier for users, more capable for programmers, and speedier for everyone.

KEY FEATURES

- Unprecedented data-retrieval speed
- Relational query-building screen
- Point-and-click application-building tools
- Handles true one-to-many relationships without programming

AVAILABILITY

Immediate

PRICING

Single-user version \$795, LAN version (unlimited users) \$1295, royalty-free distribution kit (replaces unlimited run time) \$500, API development kit \$500; upgrades (free if purchased after February 1, 1991) for single-user version \$195, for LAN version \$250, for run time to royalty-free kit \$100

Fox Software

134 W. South Boundary
Perrysburg, Ohio 43551
419/874-0162,
419/874-8678 (fax)

Reader service no. 673

Once you've extended

**WITH OUR NEW SX MODELS, IBM MAXIMIZES
THE POWER OF THE INTEL 486 CHIP. AGAIN.**



When the IBM PS/2® Models 90 and 95 XP 486™ were introduced, they burst from the starting gate with incredible power, and have held their lead brilliantly. With the introduction of the new 20 MHz SX™ models, IBM offers lower-cost entries that deliver high-powered computing. So no matter how diverse your needs, we have a champion ready for you.

All the Models 90 and 95 are designed to use the most advanced components to achieve optimum balanced performance in power, speed, storage, memory and XGA graphic resolution. Like their forerunners, the new 90 and 95 XP SX models possess a 64-bit processor-to-RAM path and advanced Micro Channel™ 32-bit architecture for lightning-fast data flow and improved data integrity. The 4MB RAM standard on the SX models is doubled to 8MB on the 25 and



got a champion, the line.



33 MHz models, so challenging hurdles like multimedia are easily cleared. The 25 and 33 MHz models also include a math co-processor for improved performance in numeric-intensive applications like financial modeling and CAD/CAM.

But perhaps the most compelling feature of today's champions is their ability to adapt to the needs of tomorrow. With Expandable Processor (XP) technology, all models can easily be upgraded to speeds faster than 33 MHz in the future. With the standard SCSI busmaster, additional hard drives, tape drives and printers can be added. You can even add multiple processors with Micro Channel busmaster adapters.

So what you get is a machine with the kind of strength, flexibility and staying power that makes a real champion.

To find out more about the leaders in 486 technology, contact your IBM Authorized Remarketer or IBM marketing representative. For a remarketer near you, call 1 800 272-3438.

How're you going to do it?
PS/2 it!

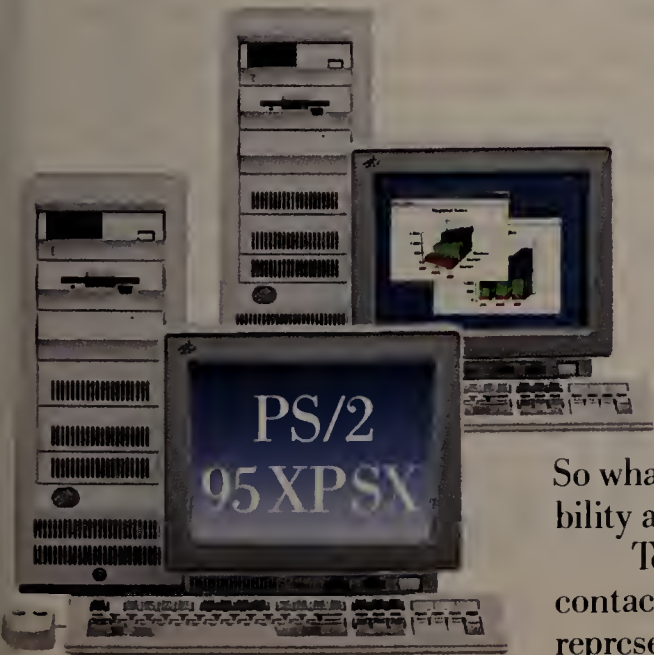

*Forms automation solutions
that get you where you want to go.*



Does important information within your company sometimes seem to take off for parts unknown? Does the right information rarely get to the right destination in the right format at the right time? If so, JetForm has the solution.

Because JetForm offers complete forms automation solutions for organizations "on the go," we can help you ensure that information virtually flies throughout your enterprise. In the process, we can save you both money and time, simplify your information management task, and boost your overall productivity.

JetForm approaches the concept of forms distribution from a systems point of view. Because we view forms as the means by which data is gathered and transmitted throughout an enterprise, all of our products (JetForm Design, JetForm Filler, JetForm Merge, and JetForm Server) are enterprise-wide solu-

tions that facilitate the transfer, handling, and formatting of information on multiple environments and platforms. Combined with our extensive experience in the Windows environment and our overall technical expertise, our philosophy enables us to soar over our competition.

No matter what the destination of your business is, we can get you where you want to go! To start your journey, just call us at 1-800-267-9976 or 613-594-3026.

JetForm Corporation, Inc., 163 Pioneer Drive, P.O. Box 606, Leominster, MA 01453. © Copyright 1991 JetForm Corporation, Inc. JetForm is a trademark of JetForm Corporation, Inc. All company and product names are trademarks or registered trademarks of their respective owners.

JETFORM

They're more than just forms. They're your business.



Edited by MIKE HOGAN

The Norton Utilities Version 6.0

A Grab Bag of Data-Saver Utilities

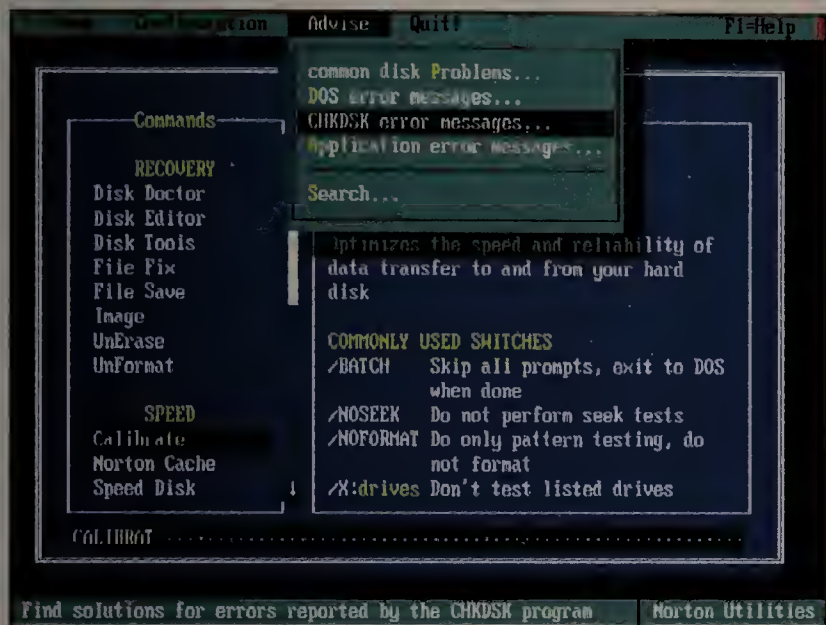

The latest Norton Utilities sports a more descriptive menu with an Advise option that suggests possible solutions to your disk and DOS problems.

Unless you're an absolute newcomer to PCs, you've heard of *The Norton Utilities*—a comprehensive package of data savers best known for restoring erased files and recovering files from disk disasters. The latest release does all that better, sports an improved interface, and includes a powerful substitute for COMMAND.COM.

The Norton Utilities 6.0 is a veritable grab bag of goodies that includes more than two dozen programs. The utilities are grouped into four general categories: data recovery and disk repair, system performance enhancement, data security, and a miscellany of tools that make your time at the DOS prompt more productive.

If you spend a lot of time there, you'll be well served by Norton's NDOS.COM replacement for COMMAND.COM. An enhanced version of the 4DOS shareware product, NDOS.COM works just like

COMMAND.COM except it implements four little-used DOS commands differently. It also adds a ton of features, among them on-line help and command history recall and editing. In addition, you get more flexible directory listings and command syntax (such as multiple commands on one line) and vastly improved batch file handling. All told, you have about 50 new commands at your disposal.

As in previous versions, the programs can be executed from the DOS prompt (*Norton* fully supports the new DOS 5.0) or launched interactively from a new master menu that's a significant improvement over the previous Norton Integrator. It boasts an optional graphical interface plus extensive customization capabilities. For example, you can add other programs to the menu, remove those you don't need, and modify the help screens. You can also specify a password to prevent access to some

of the potentially destructive programs.

Although advanced users will certainly benefit the most from the product, novices will appreciate its lucid manuals and the on-screen help that always explains what the program is doing—and provides ample warnings of dangerous consequences.

Particularly handy is the new Advise menu option that proposes solutions to specific disk problems, DOS errors, and CHKDSK errors. Besides explaining what might be causing the problem, it guides you to the appropriate utility. The product is *Windows*-aware and warns you if you attempt to perform operations such as disk defragmentation while *Windows* is active.

Other version 6 enhancements include speedier disk defragmentation, a *Windows 3.0*-compatible disk caching program, and expanded/extended memory support for the RAM-resident utilities. The Prune and Graft feature lets you relocate a directory easily, along with its subdirectories and files—with only a few keystrokes or mouse clicks. Version 6.0 lists for \$179, and \$39 for upgrades.
—John Walkenbach

IN BRIEF

The Norton Utilities Version 6.0

This all-inclusive data saver offers an improved user interface and includes a powerful substitute for COMMAND.COM.

Symantec Corp.

10201 Torre Ave.
Cupertino, CA 95014
800/441-7234

Reader service no. 618

INSIDE PRODUCT OUTLOOK

108 **MailMan 1.0** Get *Windows* E-mail today, electronic forms tomorrow.

108 **NetWare 2.2** Easy installation, improved memory management in Novell's more intelligible NOS.

110 **Picture Packer** Compress graphics images without loss of quality, and free up hard disk space.

112 **Visual BASIC** Microsoft's screen painter with compiler makes *Windows* program development easy for the part-time programmer.

112 **NEC CDR-83, Tandy CDR-1000** Affordable CD ROM drives that meet multimedia needs.

114 **Datellite 300** Use pen or finger to tap the desktop power of MicroSlate's keyboardless PC.

114 **dBASE IV Server Edition** Access your SQL data off a server and work with DBF files.

116 **Hayes Pocket Edition 2400** Miniature mobile modem lets you send and receive faxes and data from any PC on the road.

116 **Accpac Simply Accounting** Modular small-business package gets easier, better looking with *Windows*.

118 **ZyIndex for Windows** Text retriever indexes in the background and does versatile file searches.

MailMan 1.0

Windows E-Mail Has Forms in Its Future

Most of today's network electronic-mail packages not only provide the up-front tools for sending and replying to mail, but also manage connectivity tasks behind the scenes. Soon, as the market distills to a handful of back-end E-mail vendors such as Banyan, Lotus, and Microsoft, you'll see *mail-enabled applications*—front-end products that make a variety of E-mail engines more functional. One of the

new breed is *MailMan*, a slick *Windows* product that helps you manage your E-mail today and will add intelligent electronic forms to help you smooth your office's work flow tomorrow.

Like *cc:Mail for Windows*, *MailMan* takes full advantage of *Windows*, letting you keep multiple messages and folders open and cut and paste between them. A unique icon bar called the Navigator lets you flip between open messages and folders.

You also use icons or pull-downs to access *MailMan's* many features, including mailing lists and folders. Click on an attachment, and the appropriate application launches. One nice touch: You can select a group of files for moving or deleting en masse.

Today, *MailMan* works in front of VINES' E-mail engine. This fall, NetWare users should be able to buy a version that runs with Novell's new MHS 1.5 E-mail hub and

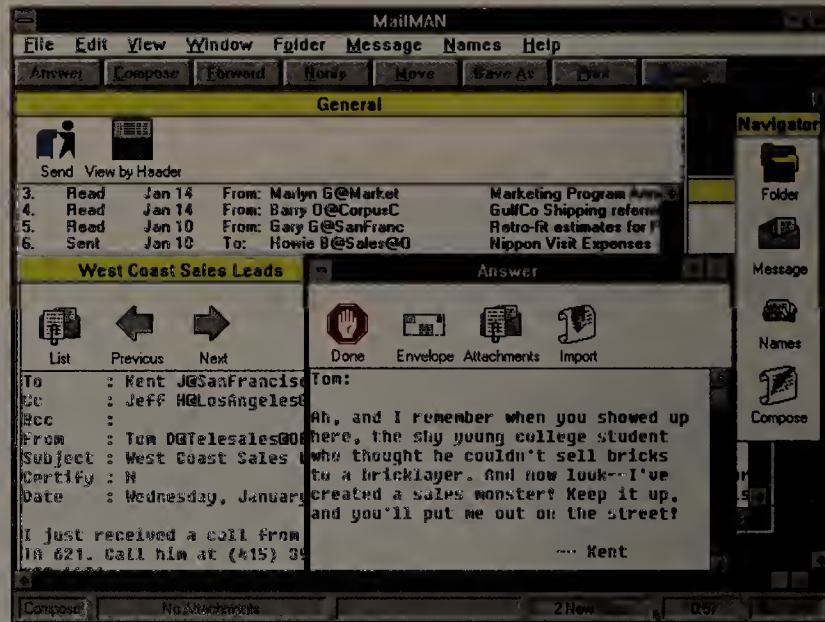

This flexible LAN E-mail manager lets you keep numerous messages, replies, and folders open at once without losing track.

works alongside E-mail products such as *cc:Mail* and *Da Vinci*. It's priced at \$995 for 20 users and \$1995 for unlimited usage per mail server.

By year-end, *MailMan* should offer new options that integrate electronic forms. Current E-mail packages lack the intelligent fields needed for forms, and current form packages lack routing and tracking. *MailMan* should bridge this gap.

The later version should let you select a form such as an

expense report, fill it out, and send it to your boss, who electronically signs it for approval and sends copies to the appropriate people. By applying intelligent rules that you can base on content, the form will know where to route itself. For example, if the loan amount field is over \$10,000, the form is automatically forwarded to a senior bank officer.

Even without forms, *MailMan's* friendly interface appears to make network E-mail easier to use. —Eric Brown

IN BRIEF

MailMan 1.0

WINDOWS This *Windows* package helps you manage your own E-mail glut today and promises to smooth your office's work flow tomorrow.

Reach Software Corp.

330 Potrero Ave.
Sunnyvale, CA 94086
408/733-8685.
408/733-0482 (fax)

Reader service no. 619

NetWare 2.2

Novell Consolidates NetWare Line

Shopping for NetWare just got a lot easier, because the confusing array of NetWare flavors has merged into two.

For servers with many users, heavy traffic, or client-server applications, there's NetWare 386 3.11 (see June's *Product Outlook*). For those with lesser demands, NetWare 2.2 offers easier installation and better memory management than the old NetWare 286 line, along with price breaks for smaller nets.

NetWare 2.2 combines all the features of the old ELS, Advanced, and SFT products

(see "Can You Do Better Than NetWare?" March 1991). That means not only transaction tracking and the backup security of disk mirroring for high-powered servers, but also a nondedicated server option for small LANs and easy installation for do-it-yourselfers. NetWare 2.2 also supports Macintosh workstations, and new Mac utilities ease network management on mixed nets.

Veterans who've mastered the arcane Netgen installation process will appreciate the painless new installation routine and quick-start instruc-

tions, while new users will just assume that's how things ought to be done. You can say good-bye to that huge, time-wasting pile of 360K floppies, too: NetWare 2.2 comes on the short stack of your choice, 1.2MB or 1.44MB disks.

Another welcome 2.2 feature is improved memory management. In previous versions, many functions made memory demands that, on heavily loaded servers, sometimes produced 'out of memory' errors that couldn't be fixed simply by adding more memory. In 2.2, NetWare's use of memory has been reorganized to give overburdened servers more breathing room.

NetWare 2.2 costs \$895 per

server for 5 users, \$1995 for 10, \$3495 for 50, and \$5495 for 100. Upgrades from earlier versions range from \$395 to \$4995. —Robert Lauriston

IN BRIEF

NetWare 2.2

Entry-level and midrange NetWare versions are now a single, easy-to-install product with better memory management, Macintosh support, and price breaks for smaller networks.

Novell

122 East 1700 South
Provo, UT 84606
800/638-9273

Reader service no. 623

DOS

peck peck peck
peck peck peck
peck peck peck
peck peck peck
peck peck peck
peck peck peck

Direct Access[®]

peck

Compared to a menu program like this, everything else is for the birds.

If you've got Direct Access, you don't need a whole flock of keystrokes to get into the programs on your hard disk.

All you do is load it and forget it. Direct Access lines up every program on a menu and lets you create custom sub-menus for related programs and other applications.

It's simple.

And it's complete. With features like user-defined screen blanking, password protection, three-level virus detection, mouse support and a unique feature that automatically tracks all time spent on your programs. A network version is also available and you can even customize

the menu with your company logo.

The choice is easy. Keep pecking away with DOS commands. Or fly into your programs with Direct Access.

Call now for complete details, volume discounts and your nearest Direct Access dealer. For a limited time, get Pyro!™, The Entertaining Screen Saver for the PC, free! Just write "Pyro" on the Direct Access registration card before you return it.



PC Magazine's Editor's Choice

Picture Packer

Image Compression Packs a Wallop

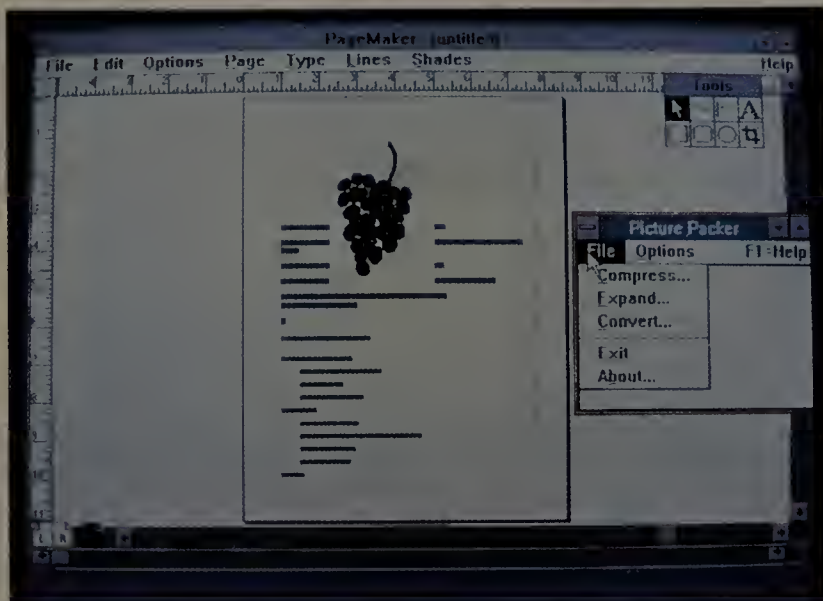

Squeeze those huge graphics files to 1/30 their original size without noticeable loss of image quality, or even smaller if precision isn't vital.

Shortly after you buy your first scanner, your hard disk starts looking about the size of something on the end of a toothpick. Even medium-resolution images fill up your platters PDQ. You could always buy another hard drive (if you have the space and don't mind switching between volumes), or you can try to squeeze more files onto the one you have with an image compressor.

Picture Packer gives you two ways to pack a picture. This \$79 program squashes disk-filling images down to 1/30 their original size without noticeable deterioration or down to 1/50 if you're willing to sacrifice image quality. The process is fairly quick: On a 20-MHz 386 computer, it takes 20 to 25 seconds to compress a 500K file to as little as 10K.

If you're a serious desktop publisher or presentation maker working with a superabundance of large graphics files, you can cut compression time down to less than 5 seconds by adding *Picture Packer's* \$595 accelerator card, which uses a Texas Instruments digital signal processor. A \$100 coupon in every copy of the software means you won't

be penalized if you try the software first and go for the accelerator card later.

Picture Packer will compress TARGA, TIFF, PCX, and GIF, a lineup that should cover most of the formats used for desktop presentation, publishing, and animation applications. However, *Picture Pack-*

SBT Database Accounting Library Professional Series

Package Targets the High End

Hoping to capitalize on the trend toward smaller systems, SBT has released a high-end accounting package for PC-based networks. *Database Accounting Library Professional Series* is for the company that wants to move its accounting system from a mini or mainframe to a PC net.

The *Professional Series* features pulldown menus and pop-up dialog boxes for easier data lookup. The program includes memo fields for keeping detailed notes on individual customers or vendors and customizable context-sensitive help.

Currently, only seven mod-

ules are available: general ledger, accounts receivable, accounts payable, sales order, purchase order, inventory control, and the required system manager module. But SBT plans a wider range of modules, as well as contact and communications manager options—both of which are currently available for the firm's dBASE-based *Accounting Library Series Six*. (SBT wrote the latest version in Fox's faster *FoxPro*.)

Professional Series requires 540K of memory (expanded memory is recommended), DOS 3.1 or later, 7MB of storage for the system

er converts them to TIFF or TARGA format, as you choose, so it outputs only those formats after decompression. It comes with an interface for DOS and one for *Windows 3.0*. Like most programs of its ilk, *Picture Packer* utilizes Joint Photographic Experts Group (JPEG) compression to save time and space. No problem for graphics files, even when you intend to print them at 300 dpi. But the manufacturer doesn't recommend *Picture Packer* for compressing data base or text files. Also, you won't want to use the higher-compression sampling technique on scientific or color prepress graphics applications, where every pixel is precious. But you can set *Picture Packer* to save every bit and still get compression of 5 to 1.

Decompression integrates smoothly with your day-to-day applications, thanks to a memory-resident utility that requires only 19K of conventional memory. When you call up a compressed TARGA or TIFF file, the package automatically

decompresses it for you without making you leave your application.

Video & Image Compression includes a royalty-free utility you can give to friends in case you want to speed your modem transmissions by sending compressed files. You need at least a 286-based PC for either version of *Picture Packer*, plus DOS 3.0 or later. —Mark Henricks

IN BRIEF

Picture Packer

WINDOWS You can squash large graphics files down to 1/50 their original size and decompress and retrieve them in under 5 seconds with this hardware/software combination.

Video & Image Compression Corp.

21311 Hawthorne Blvd.
#235
Torrance, CA 90503
800/472-1888,
213/543-2117 (fax)

Reader service no. 628

manager, and 3MB for each module. A 386 is highly recommended. Individual modules sell for \$1295, except the inventory control module, which retails for \$395. Source code is included in the purchase price. —Roberta Furger

IN BRIEF

SBT Database Accounting Library Professional Series

SBT's *Professional Series* brings greater speed and flexibility to the high-end accounting market.

SBT Corp.

One Harbor Dr.
Sausalito, CA 94965
415/331-9900

Reader service no. 631

Send my Fastback Plus Upgrade. Fast.

Fastback or Fastback Plus users only! Upgrade to Fastback Plus 3.0 for only \$49.

Free Overnight Delivery* • 1-year Money-Back Guarantee

Multiple Copy Registration

A serial number is required for each unit ordered. Please list additional serial numbers on a separate sheet and enclose with your order.

Serial No.

Serial No.

Serial No.

Serial No.

Serial No.

Serial No.

Mail this order form to:

P.O. Box 83260

Baton Rouge, LA. 70884-9928

For Faster Service:

Call Toll-Free: 800-933-0108,

or fax your order to 504-291-5453.

See reverse side for additional information.

*Within the U.S. only. International orders shipped free by regular mail.



Yes! I want _____ copies of the Fastback Plus 3.0 Upgrade at \$49 each. Enclosed is my payment or credit card information.

Payment Method

VISA MasterCard American Express
Card No.: _____ Expiration: _____

Signature: _____

Please print.

Name

Address

City State Zip

Current program version Serial No.

Daytime Phone Number Title

I purchased Fastback Plus after February 1, 1991. Please send me the upgrade for FREE. I've enclosed a copy of my dated receipt.
 Check or money order made out to Fifth Generation Systems, Inc.
Check No.: _____
Sorry, no PO's or COD's accepted.

Send me _____ copies at \$49=Subtotal _____

Sales Tax
(Residents of LA, GA, TX, CA, NY, IL and the District of Columbia must add applicable tax.)
TOTAL _____

**For Faster Service: Call Toll-Free: (U.S.)-800-933-0108;
(Outside U.S.)-504-291-7221;
or fax your order to 504-291-5453.**

Introducing Fastback Plus 3.0

Users will automatically like it.

The rest of you will like it because it's automatic.



You should like it; after all, your suggestions helped design it. But we didn't stop there. After we made improvements you asked for, like a new windows-style interface, we added plenty of others.

If you're not backing up regularly, you either don't have the right backup program, or you don't have one at all. Fastback Plus 3.0 solves both problems with an entire program full of time and effort-saving features that make backing up so automatic, you can literally do it in your sleep.

- An archiving feature that erases unwanted files after backup
- Faster backups and restores: up to 10 mb/minute on some PCs (up to 3mb/minute on an average AT)
- Increased data compression to a full 80 percent, 15% more than version 2.1
- Appending incremental backups
- dBase III-compatible history file database lets you search for and restore specific files
- Backup support for "Bindery and Trustee" files on Novell Netware 286/386

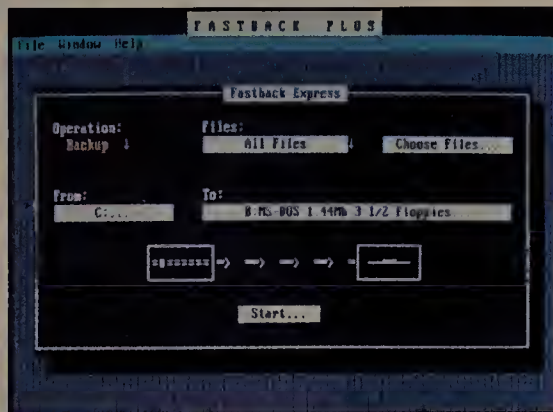

The new fast, simple Express Menu.

- Scheduler and macro recorder for fully-automated, unattended backups
- Macro editor in plain English instead of DOS commands
- Optional password protection with DES file encryption capability
- New easy-to-use, windows-style interface with Express Menu
- Advanced error correction for recovering data from damaged disks

And like all Fifth Generation products, Fastback Plus 3.0 is automatically covered by a one-year, money-back guarantee. Upgrade now for only \$49 and get FREE overnight delivery*. Just mail or fax the attached reply card with your payment to the address or fax number below. Or call us toll-free. This offer is limited to Fastback or Fastback Plus users with a valid program serial number.

And these are just a few of Fastback Plus 3.0's new features. Now more than ever, there's really no excuse not to back up your data. Because if you don't want to do it, this program will do it for you. Automatically. For more about Fastback Plus 3.0, call the toll-free number below.



8 0 0 - 9 3 3 - 0 1 0 8

Fifth Generation Systems • 10049 N. Reiger Road • Baton Rouge, LA 70809
(504) 291-7221 Fax: (504) 291-5453

*U.S. destinations only. Fastback Plus 3.0 will not restore backups made with versions 2.09 or earlier.
dBase III and Novell Netware are the respective trademarks of Ashton-Tate, Inc. and Novell, Inc.

Circle 71 on reader service card

Visual BASIC

Easier Entry for Windows Programming

Microsoft invented *Windows* but did little to make programming in the environment anything but a chore. It took archrival Borland's *Turbo Pascal for Windows* and Borland *C++* to make *Windows* program development—with traditional languages and

EXE file results—a reasonable undertaking. Microsoft is firing back with a relatively easy-to-use compiler, *Visual BASIC*.

Visual BASIC is easy to learn and use. It's intended for the part-time programmer—someone who needs something more versatile than Asymetrix's *ToolBook* but who isn't ready for *Turbo Pascal for Windows*. *Visual BASIC* is a screen painter with a BASIC compiler attached. You design a window with buttons, graphics, text boxes, whatever. In another window, you write BASIC code to define what occurs when an event (such as a click or keystroke) happens to that object.

The package feels a lot like *ToolBook* but produces EXE files that can be run inside *Windows* without a run time, and you're a step ahead if you

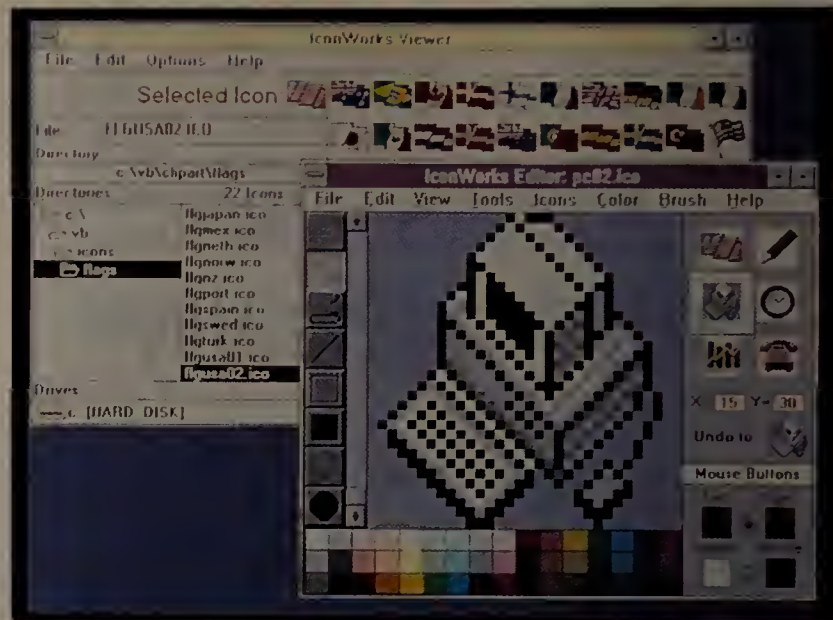

This Microsoft compiler simplifies Windows programming through the use of on-screen objects.

already know BASIC. However, unlike most language products, *Visual BASIC* leaves you stuck with the bundled editor because the source-code files contain binary graphic information as well as BASIC code. And the program can't do everything a C or Pascal compiler can; it doesn't support a lot of the

weirder *Windows* events and functions. *Visual BASIC* is open ended so new capabilities can be added, but you'll probably need C to do it.

Visual BASIC requires *Windows 3.0* and lists for \$199—as inexpensive as development tools for the nonprofessional should be. —Lincoln Spector

IN BRIEF

Visual BASIC

WINDOWS Microsoft's development tool eases *Windows* programming by letting you paint your screens in one window and compile code in another.

Microsoft Corp.

One Microsoft Way
Redmond, WA
98052-6399
800/227-4679,
206/883-8101 (fax)

Reader service no. 621

NEC CDR-83, Tandy CDR-1000

Fast and Faster CD ROM Drives Rev Up Multimedia

Multimedia may be the buzzword of the nineties, but the majority of the equipment it requires is still priced well beyond the reach of most users. New CD ROM players from NEC and Tandy, however, deliver the massive storage needed for graphics-intensive multimedia applications at a price you can afford.

Tandy's CDR-1000 is the first truly inexpensive internal CD ROM drive designed to meet the performance demands of multimedia applications with a 150K-per-second continuous data transfer rate. For a higher price, NEC Technologies' CDR-83 internal drive matches Tandy's transfer rate and goes a step fur-

ther to add the much quicker average access time that many applications require to function well.

The Tandy CDR-1000 is a ready-to-go CD ROM drive that, despite its unusually slow 900ms access time, produces a data transfer rate sufficient for smooth animation with continuous sound. And \$400 buys everything you need to run the drive, including the interface card and software. Tandy also gives you an innovative disk tray assembly that eliminates the need for a clumsy disk caddy.

The \$999 list price on NEC's CDR-83 (with interface kit included) is more than double that of the Tandy, and

you'll have to add another \$100 for PS/2-compatible and CDR-73 external versions. But you can expect to see the NEC drives discounted at independent resellers, whereas Tandy's Radio Shack outlets will provide you with no such price cuts. In addition, the NEC is a 300ms quick-access drive, which will enhance its usefulness for reference applications or uses requiring random seeks. And NEC throws in a two-year warranty to enhance your feeling of security. The CDR-83 is also XA ready, so you'll be able to run any multimedia application set up to work with this audio compression/storage standard. —Rex Farrance

IN BRIEF

NEC CDR-83, Tandy CDR-1000

Multimedia gets closer to your desktop as affordable new CD ROM drives from NEC Technologies and Tandy Corporation provide the storage and data transmission rate needed for smooth animation with continuous sound.

NEC Technologies, Inc.

1255 Michael Dr.
Wood Dale, IL 60191
708/860-9500

Reader service no. 626

Radio Shack

Tandy Corp.
700 One Tandy Center
Fort Worth, TX 76102
817/390-3300

Reader service no. 627

Until now, sharing a printer could cause excessive wear on some of your equipment.



If you're on a sneaker network running between several PCs and one printer, your patience and productivity—among other things—are probably wearing a little thin.

And it could be worse. Major manufacturers report that you may actually damage your laser printer if you use a mechanical switchbox. But now there's The Logical Connection Jr.™

The Logical Connection Jr. safely connects four PCs to a single parallel printer using easy-to-install phone wires.

Working entirely with its own memory, it manages all incoming print jobs simultaneously in the background, freeing your PCs for business while it prints jobs in the order received. And although it

runs beautifully without any software, it comes with a powerful utility program that maximizes printing speed. And it does all that for less than \$60 per PC.

To find out more about The Logical Connection Jr., call 1-800-388-0362. Buy it, and we'll foot the bill for a free copy of Mace Performance™, the \$69 hard disk optimizer. Just write "sneaker network" on the registration card and return it to us.

This is a limited-time offer, so step on it.

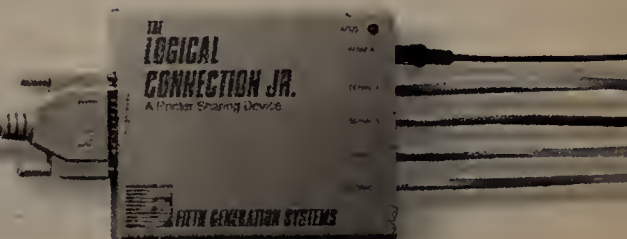

Fifth Generation Systems, Inc.
10049 N. Reiger Road, Baton Rouge, LA 70809
Technical Support: (504) 291-7283

Circle 235 on reader service card

Datellite 300

Have Pen, Will Travel: Notebook PC Driven by Touch-Screen



This pen-based PC has enough power and expandability for true keyboardless applications and a "touch screen" for fingertip computing.

If keyboardless computers are to take their place alongside their keyboard-equipped cousins, they must be more than novelties. Thanks to ample processing power and extras like a touch-sensitive screen that responds to pen or finger, the Datellite 300 is powerful but won't tie you down.

With a 20-MHz 386SX CPU, the \$5995 Datellite 300 packs desktop-style punch. It lacks an internal floppy, but standard features include a math coprocessor socket, 2MB of memory expandable to 16MB on the system board, and a 40MB hard drive. There's no expansion chassis, but you can make connections through its SCSI port to a CD ROM drive or to external VGA monitors and keyboards through dedicated ports, and you may start asking yourself if you need your desktop.

At 6.6 pounds with battery, the Datellite is notebook light. Because the keyboard has been jettisoned, you rely mostly on the unit's VGA, 9-inch diagonal, backlit LCD screen with a touch-sensitive membrane that you tap with a stylus or your finger. You use the bundled DataSlate application generator to create applications for on-the-road data

entry, and phrases for use in short memos, in concert with an on-screen "keyboard."

Driven by a finger instead

dBASE IV Server Edition

dBASE Finally Goes SQL—Sort of

Ashton-Tate has been talking about SQL support in *dBASE IV* for as long as it's been talking about *dBASE IV*. With the *dBASE IV Server Edition*, it's turning talk into action.

This version of *dBASE IV* lets you access SQL data off a server, in addition to working with standard DBF files. The initial release supports the Microsoft/Sybase *SQL Server*; Ashton-Tate promises that future versions will support other SQL dialects.

You can access SQL data through a combination of dBASE and SQL commands, either in programmed applications or interactively at the dot prompt. But that's as easy as it gets; *dBASE*'s excellent query-by-example data-retrieval method doesn't work on server-based data. And even when you've given up on menus and are programming your queries, you can't use such famil-

of a mouse, the Datellite 300 runs DOS applications and even *Windows 3.0*, so you can build your applications under both environments. The company claims that programs from other slate computers, including Grid's GridPad, can be ported without much trouble.

You can't create long documents on the Datellite 300 screen yet because it lacks handwriting recognition software. However, MicroSlate promises to support the recognition capabilities of Microsoft's *Pen Windows* and Go Corporation's *PenPoint* when these products appear.

Options include an external

1.44MB floppy for \$350, a 19ms internal 120MB SCSI hard drive for \$1000, a \$300 internal 2400-baud modem, and additional \$198 battery packs, each rated at 4 hours. —Mark Henricks

IN BRIEF

Datellite 300

The Datellite 300 keyboardless system brings real desktop power to pen-based computing, along with a bundled application generator.

MicroSlate

9625 Ignace St., Ste. D
Brossard, Quebec
J4Y 2P3 Canada
514/444-3680,
514/444-3683 (fax)

Reader service no. 620

Server, it's all you've got.

dBASE IV Server Edition requires DOS 3.1 or a later version, a 286 or more powerful computer, and 640K of standard memory plus 1MB of extended memory. The program can take as little as 100K of standard memory, running the rest in extended to give you plenty of room for memory-resident packages and network drivers. It retails for \$1295 for the 3-user version and \$7995 for the 20-user version. —Lincoln Spector

IN BRIEF

dBASE IV Server Edition

This LAN-based product lets you reach out and touch your SQL data—although not quite as easily as you can tap your *dBASE* files.

Ashton-Tate Corp.

20101 Hamilton Ave.
Torrance, CA 90509
213/329-8000,
213/538-7998 (fax)

Reader service no. 624

Set Your Sights on Simply The Best

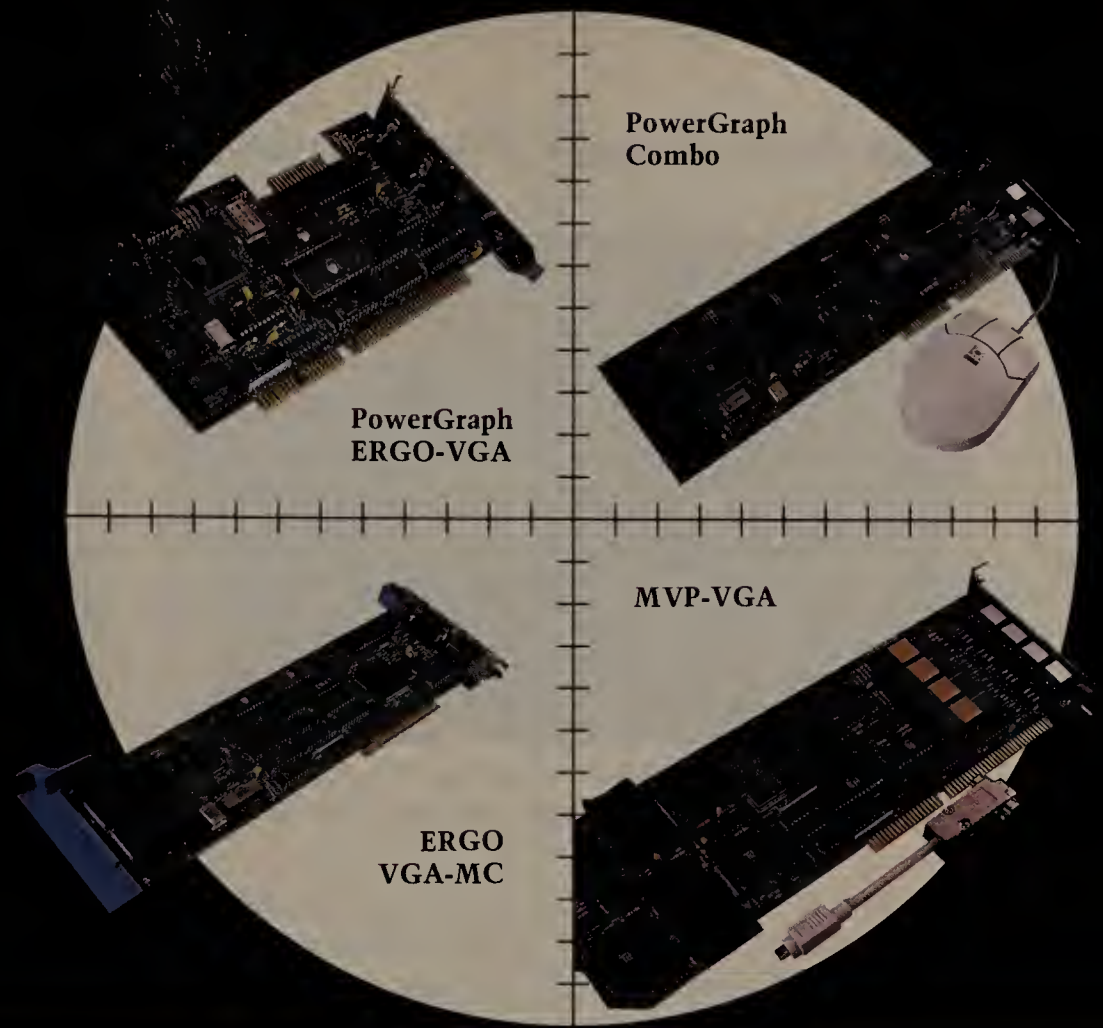

Since 1981, STB has been shooting down the competition with innovative expansion products for PCs. In that tradition, STB presents four new Super VGA Power Peripherals.

PowerGraph ERGO-VGA

- High screen refresh rates for "Flicker-Free" operation
- InfoWorld Review Top Finisher, April, 1991



PowerGraph Combo

- Super VGA, disk controller, serial and parallel ports and mouse on one card
- Logitech MouseMan included

ERGO VGA-MC

- Higher resolutions and High Color Super VGA for Micro-Channel Systems
- High screen refresh rates for "Flicker-Free" operation

MVP-VGA

- 2 or 4 Super VGA video ports on one card
- Windows and OS/2 multi-screen drivers available

All video cards in the PowerGraph family use the same high-performance graphics chip to insure software compatibility. They provide resolutions up to 1024 X 768 and are compatible with the Video Electronics Standards Association (VESA) standards. In addition, all boards provide ergonomic, flicker-free operation in many video modes.

PowerGraph family options allow each of the adapters to display bit-mapped images using up to 32,768 colors, or to greatly enhance the appearance of fonts and vector drawings using sophisticated anti-aliasing techniques.

You Can't Miss With STB Power Peripherals

STB Systems, Inc. • 1651 N. Glenville, Suite 210 • Richardson, TX 75081

(214) 234-8750

Video

Memory

Disk Controllers

I/O



STB Systems, Inc.

Other company and product names are trademarks or registered trademarks of their respective companies

Circle 243 on reader service card

Hayes Pocket Edition 2400

Downloading Files or Faxes More Cheaply at Home or Away

Being on the road doesn't mean you're cut off from your home and office PCs and fax machine. Hayes has created a 3-ounce, 3-inch modem that you can easily slip into the pocket of your coat, your laptop carrying case, or your briefcase—and it lets you hook up to your own laptop or a PC you find at your destination. Moreover, the Hayes Pocket Edition 2400 comes in at \$179—a bargain compared with the \$300 price tags of some competitors.

The Pocket Edition proves an even smarter buy if you take advantage of its bundled *Smartcom EZ* software to send and receive faxes through an information service such as MCI while on the road. This method of faxing costs less than \$1 per page instead of the \$5 a page you pay at some hotels. Faxing from your own computer is more private and assures you of more legible transmissions. If the line you

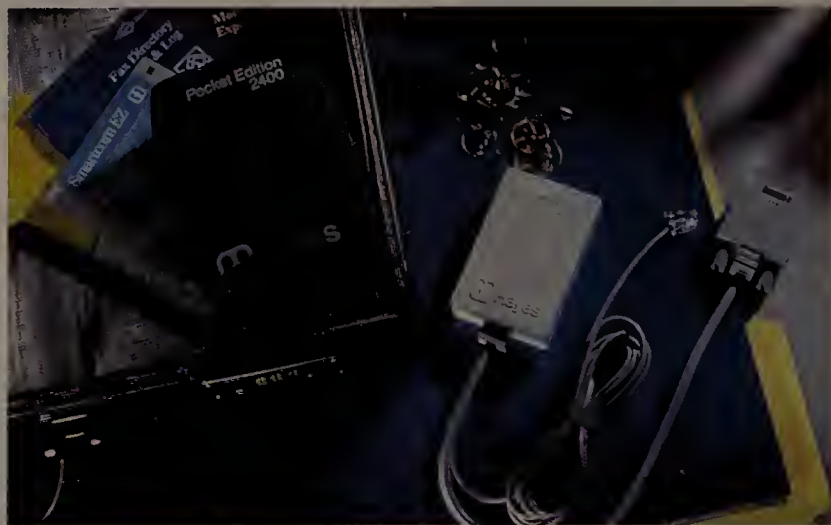

This diminutive 2400-baud modem is big on ease of use thanks to the friendly directories and keyboard macros in the *Smartcom EZ* software.

are trying to reach is busy, most services will keep trying. *Smartcom EZ*'s phone directory comes with the numbers of MCI, CompuServe, and other popular mail services.

Smartcom EZ also contains other friendly features like the ability to dial and answer data transmissions from numbers in your own personal phone directory, an unlimited number of keyboard macros,

and the ability to connect directly to a mainframe or mini. You also get on-line help.

Using an XMODEM protocol, *Smartcom EZ* steps down data speeds from 2400 baud to 300 baud as necessary. If XMODEM doesn't have enough error correction for your tastes, you can get a ZMODEM protocol by upgrading to Hayes's *Smartcom Exec* modem software. (The

regular \$55 upgrades to *Smartcom Exec* are only \$35 through July 31.) However, even *Exec* lacks MNP-5's more powerful compression and error correction capabilities.

The Pocket Edition comes with a 6-foot telephone cord, an 18-inch serial cable, and a carrying case. Unlike most of its rivals, it runs completely off the power from telephone lines and the PC, so it requires neither battery pack nor electrical outlet. —Susan Lusty

IN BRIEF

Hayes Pocket Edition 2400

This pocket-sized modem makes it practical to send and receive data and faxes from any PC on the road.

Hayes Microcomputer Products, Inc.

P.O. Box 105203
Atlanta, GA 30348
800/874-2937,
404/441-1617,
404/449-0087 (fax)
Reader service no. 630

Accpac Simply Accounting

Multitasking Accountant: The Better to Open the Books

Thanks to the *Windows* environment's multitasking and graphical interface, you now can get a better look at the books, and more control over your company's finances, in Computer Associates' long-running integrated small-business package, *Accpac Simply Accounting*.

You can navigate easily among *Simply Accounting*'s general ledger, accounts payable, accounts receivable, inventory control, payroll, and job cost modules, as well as capitalize on the close match between on-screen display and printout. For example, when

paying a bill, you get a copy of the printed check on screen. Pop-up lists also are available throughout the program for quick reference to information on employees, customers, or vendors.

Unfortunately, *Simply Accounting* doesn't support the environment's other high-end capabilities, such as Dynamic Data Exchange (which allows you to funnel data to and from other *Windows* applications).

Owners of Computer Associates' other entry-level accounting package, *Accpac Bedford*, can move over to the \$199 *Accpac Simply Account-*

ing for \$100. A free conversion utility transfers all *Bedford* files to *Simply Accounting*'s *Windows*-based format.

Accpac Simply Accounting requires at least a 286 with 1MB of RAM, *Windows 3.0*, and an EGA monitor, but a 386SX with 2MB or more is recommended.

Purchasers of *Simply Accounting* get two free calls to Computer Associates' technical support line upon registering the product. An extended support plan is available for \$99 (\$75 if purchased within 30 days of registering the product) and includes four toll-

free technical support calls and free upgrades for one year. —Roberta Furger

IN BRIEF

Accpac Simply Accounting

WINDOWS Get a better look at your books with this *Windows*-based integrated package—which also makes your books look better.

Computer Associates International, Inc.

1240 McKay Dr.
San Jose, CA 95131
800/531-5236,
408/432-1727
Reader service no. 629

Bend Us. Shape Us. Any Way You Want To.

As long as you love us, it's all right. And love us you will. Statistical software from SPSS is designed to work the way you work. By giving you the power to enter, edit, manage, analyze and present data on virtually every type of PC, workstation, minicomputer and mainframe. By giving you better decision-making ability through the most comprehensive set of statistical procedures available. And by giving you a choice of options to meet your specific data analysis needs. So if you're thinking about statistical software, think about flexibility. Because flexibility means value. And when it comes to value, we top the charts.

The Accessibility of SPSS makes it ideal for beginners and advanced users alike. With its straightforward menus and context-sensitive help and statistical glossary, SPSS gets you started fast. And with the help of our time-saving programming facilities, including macros and a matrix language, you'll have the power to go deeper even faster. And regardless of your experience with statistics, you'll be supported by the documentation and training that's set the industry standard for over 25 years. Documentation that INFOWORLD calls "The Best in the Business."

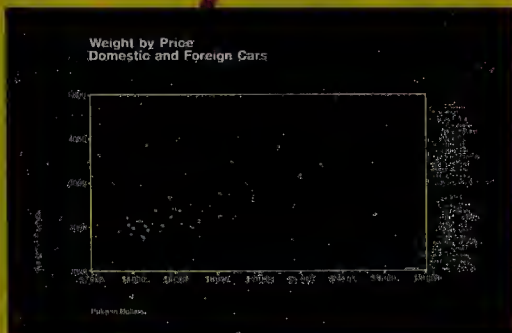
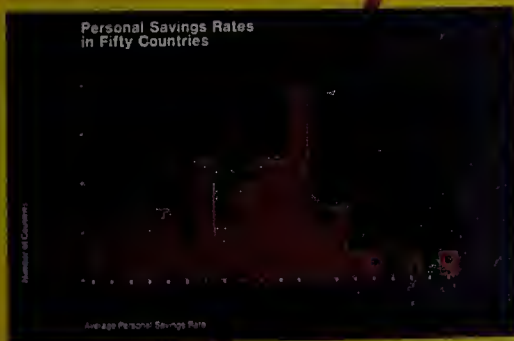

The Statistical Procedures in SPSS give you the power to examine data more thoroughly, revealing patterns that might otherwise go unnoticed. We offer the most in-depth group of statistical procedures available, including univariate and multivariate descriptives, model building, hypothesis testing, clustering and classification, survival analysis, time series and perceptual mapping. No matter what your question, SPSS provides the flexibility to find the answer.

The Data and File Management capabilities of SPSS give you unparalleled flexibility when preparing data for analysis. With SPSS, information can be quickly reorganized, cleaned and transformed, regardless of size or structure. Multiple missing values for nonresponses can be defined and labeled according to your specifications, while built-in controls easily manage information stored in complex file formats, including custom file formats. Self-documenting portable files give you the freedom to move your analysis from one computing environment to the next, saving time and resources. And because SPSS supports most popular microcomputer file types including Lotus®, DBF and SYLK, and offers free interfaces to such leading SQL-based database management systems as Informix™, ORACLE® and Sybase™, there's no need to re-enter data or write out intermediate files.

The Choice of Options offered by SPSS provides the flexibility to meet both your immediate and future data analysis needs. Unlike other statistical packages, we give you more than just the ability to choose between the options you may or may not need. We give you a choice of options designed to work together. Options that work as a system, providing the best possible software solution. Options for data entry and editing. Or producing publication-ready tables and reports. Options to analyze the past and help predict the future. Or to present your results with over 40 high-impact color displays, including a variety of charts and maps. No matter what you do, SPSS can help you do it better.

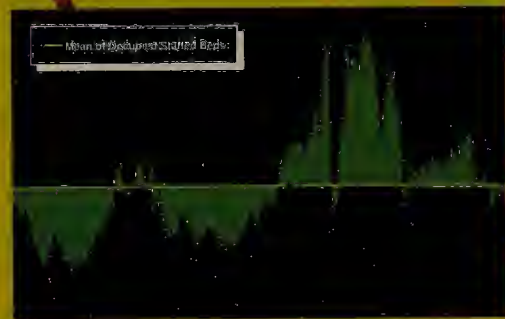

So if you're in the market for statistical software, keep an open mind. Go with the value of SPSS, suppliers of statistical solutions to over 2 million users worldwide. Because when you have the advantage of flexibility, the chances are you'll still be a hit tomorrow.

Call 1(800)543-5837 or FAX (312) 329-3668.

SPSS

We're Making It Easier To Decide.



Statistical Software For All Leading Computing Environments. Offices in Chicago · Washington, DC · Chertsey, UK · Gorinchem, The Netherlands · Munich · Singapore · Stockholm · Sydney · Tokyo · And Distributors Worldwide

Circle 253 on reader service card

Norton Backup for Windows

Look Ma, No-Hands Backup

Backing up makes the most of *Windows* multitasking. Not only does a *Windows* version of *Norton Backup* allow you to stay in *Windows* while you back up, *Norton* does the job in the background, leaving you free to do other tasks.

Since the program uses a direct memory access (DMA) channel instead of going through the CPU, it receives a real speed boost. For example,

we backed up 42MB in only 20 minutes—to 1.2MB floppy disks!

You also can back up to another hard disk, a network server, a Bernoulli drive, or any DOS device, and you can schedule *Norton Backup* to do its job even when you aren't there.

Unfortunately, the first release of *Norton Backup for Windows* doesn't support tape backup systems, although Symantec says that capability should be available in an upgrade due out this fall.

Everything else you would expect to find in a backup program is provided. You can perform both full and incremental backups. You can save your setup files for future backups, specifying the file types to back up by extension, date, and a number of other characteristics.

The program provides an attractive directory tree for selecting and excluding spe-



A true *Windows* product, this utility from Norton lets you back up in the background and offers easy menu navigation with drop-down menus.

cific files. You can even view file contents on the fly to determine whether you want to include a specific file in the backup process.

But the slickest thing about *Norton Backup for Windows* is the interface. The program implements the *Windows* interface completely, with nicely designed scroll boxes, 3-D push buttons, and the like.

Operations are all point and shoot. The automated install

routine, for example, lets you select a different drive for installation by pointing to a drive icon instead of typing its name. And every step of the way, *Norton Backup* gives you complete information about the operation that's in progress.

The program works on NetWare (version 2.12 or later) and *LAN Manager* networks and costs \$129. —Patrick Marshall

IN BRIEF

Norton Backup for Windows

WINDOWS You don't have to leave *Windows* to back up, and you don't have to watch the operation.

Symantec Corp.

10201 Torre Ave.
Cupertino, CA
95014-2132
800/441-7234,
408/252-4694 (fax)

Reader service no. 622

ZyIndex for Windows 1.0

How to Find Anything in Windows

The old text-retrieval standby *ZyIndex* works like magic to sort and retrieve text files speedily, using whatever keywords you can recall. But it's always required an irksome routine of regular file indexing. The new *Windows* version of *ZyIndex* cuts through that bother by performing updates in the background while you go about your other business (and you can program *ZyIndex* to do this automatically at a given time each day or week).

In making the move to *Windows*, the already comprehensive *ZyIndex* gains new

benefits while retaining a fairly modest 2MB memory requirement. *ZyIndex for Windows* can search on date ranges and perform *quorum searches*—that is, display files that contain, say, three terms out of a possible five. It also does away with the DOS version's file limitation: This program can search as many files as you can cram onto your hard disk.

ZyIndex enables you to write two lines of search conditions and use wild cards for a fuzzy search. You can set up Boolean conditions, and you can even conduct synonym

searches using the program's on-line thesaurus.

ZyIndex's speed comes at a cost. The program needs to generate and regularly update an index of your word processing files. The index usually requires 20 percent of the volume of the original files, meaning that indexing 20MB of word processing files can require another 4MB of disk space.

A few niggling limitations mar the program's otherwise powerful set of features. Though *ZyIndex for Windows* can index and search pretty much any word processing file, your spreadsheet, data base, and desktop publishing files remain out of reach unless you save them in ASCII format.

And the *Windows* program lacks DOS-based *ZyIndex Plus*'s report generator—though this is a quibble for a program that costs only \$395. —Matthew Lake

IN BRIEF

ZyIndex for Windows 1.0

WINDOWS The *Windows* version of ZyLab's text-retrieval software offers background indexing and more powerful searches.

ZyLab Corp.

100 Lexington Dr. #201
Buffalo Grove, IL 60089
800/544-6339,
708/459-8054 (fax)

Reader service no. 625

J.D. POWER AND ASSOCIATES JUST PUT US IN OUR PLACE.

J.D. POWER AND ASSOCIATES

PERSONAL COMPUTER CUSTOMER SATISFACTION RANKINGS*

1. Dell
2. Apple
3. AST
4. Hewlett-Packard
5. Everex
6. CompuAdd
6. Compaq
8. Epson
9. Toshiba
10. NEC

J. D. Power and Associates just released these results from its first ever computer industry Customer Satisfaction Index for PCs in Small to Medium Size Businesses. And if you'll pardon any immodesty, we're proud to share them with you. To find out more impressive facts about Dell, see the following pages.



800-626-4806

For more information call the number above.
Hours: 7am-9pm CT M-F 8am-4pm CT SAT

VGA graphics.
Non-interlaced 256-color at
800 x 600 or 16-color at
1024 x 768 resolution, built
into the system board. No
video cards. No flicker.

Upgrade easily to a higher performance
version of Intel® 80486 (when available).

Custom memory controller
ASICs deliver higher performance
and reliability than standard PAL.

Behind the SmartVu module
lies industry standard SIMMs
so extra memory can be added
easily and inexpensively.

SmartVu Diagnostic Display
troubleshoots even if the
monitor is not working.

NOBODY ELSE HAS THE GUTS TO SAY THIS.

Dell's ingenious i486™ system
innovations not only help you outwit
your competition, they help us
outwit ours.

Our high-powered i486 PC is the
Dell® 433DE, running at 33 MHz. Built

*Performance Enhancements: Within the first megabyte of memory 384 KB of memory is reserved by the system to enhance performance. Can be optionally disabled. All prices and specifications are subject to change without vary. Dell is a registered trademark, SmartVu is a trademark and TechFax is a service mark of Dell Computer Corporation. i486 is a trademark and Intel is a registered trademark of Intel Corporation. Other trademarks and by Xerox Corporation. On-site service may not be available in certain remote locations. Shipping, handling, and applicable sales tax not included in the price. For information on and a copy of Dell's 30-day Total Satisfaction

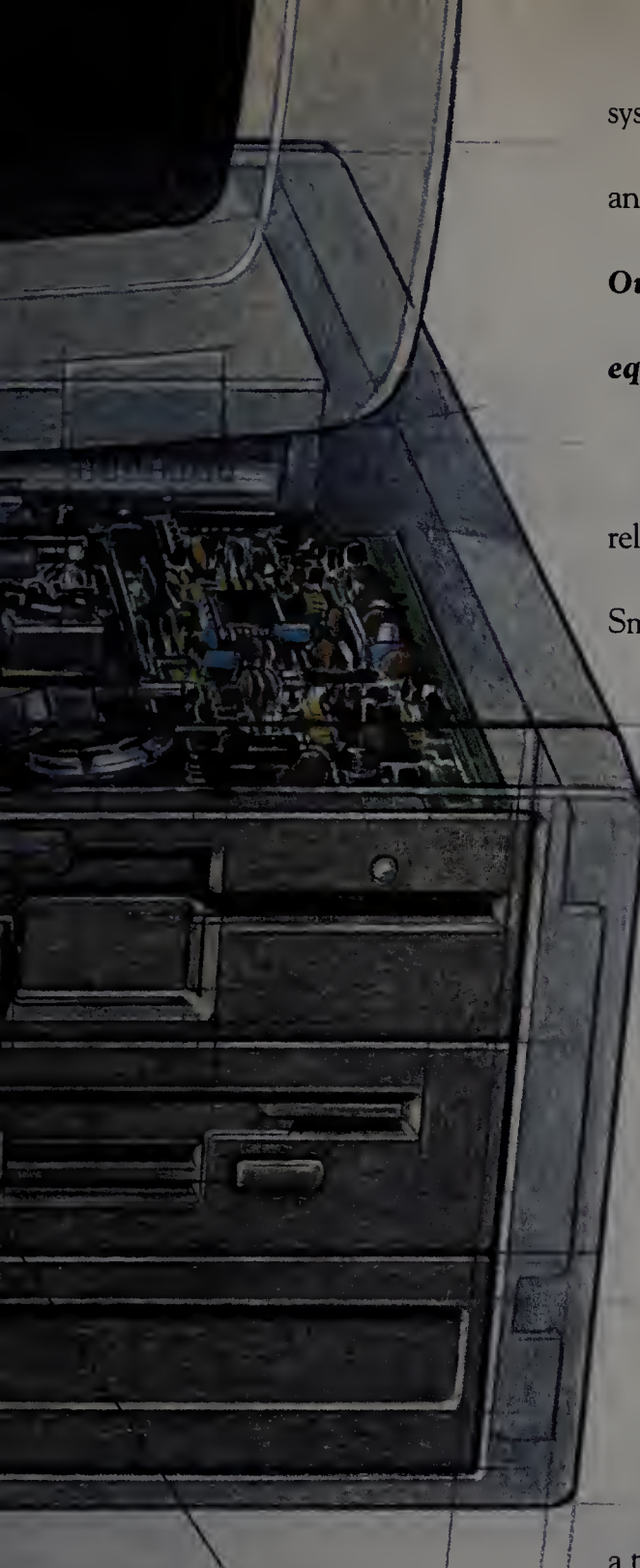

system to include a full range of upgrade and expansion capabilities.

Our service and support program is equally impressive.

Although our systems are very reliable, the Dell 433DE troubleshooter,

SmartVu™ can diagnose most

problems even if the monitor goes down. In addition, our toll-free technical hotline solves 90% of reported problems over the phone, usually in 6 minutes or less. You can also get system information 24 hours a day via our innovative TechFaxSM line.

If we still haven't solved your problem, a trained technician can be at your desk-side the next business day as part of the on-site service contract, included in the system price for the first year.^Δ

As a result of this customer commitment and our technological strength, Dell has won the PC Week

Corporate Satisfaction Poll for PCs an unprecedented eight times now.

Now that we've poured our guts out, it's your turn.

Just describe your needs and we'll help you configure the ultimate powerhouse.

Which we'll custom build, test, and ship

to you with a 30-day no questions asked money back guarantee, and a one-year limited warranty.

We also make available a variety of financial products that can be tailored to meet your business needs.

All this, plus the fact that the Dell 433DE costs so much

less than many i486 systems, may make those others a little hard to stomach.

TO ORDER, CALL PLEASE REFERENCE #11D40.
800-626-4809
HOURS: 7AM-9PM CT MON-FRI 8AM-4PM CT SAT
IN CANADA 800-387-5752. IN MEXICO 95-800-010-0664.

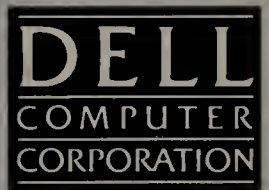

BIOS is on Flash EPROM. Upgrade or modify from floppy without removing chips.

on the EISA bus, it has unique features that give it plenty of muscle for CAD, CAE, animation, 3D, solids modeling and other applications where maximum performance is required.

Furthermore, we've designed the



Call us today.

HERE'S THE SUPPORT YOU'LL GET.

- ~ Toll-free technical support hotline for the life of your system.
- ~ One full year of on-site service included in the system price.^Δ
- ~ Self-diagnostic software.
- ~ Toll-free 24-hour TechFax line for instant access to Dell technical information.
- ~ On-line Bulletin Board to communicate with Dell technical staff and other Dell users.

THE NEW DELL 433DE 33 MHz i486 SYSTEM
SYSTEM INCLUDES VGA COLOR PLUS MONITOR, 100 MB HARD DRIVE, 4 MB RAM.*

notice. Dell cannot be responsible for errors in typography or photography. **Payment based on 36-month, open-end lease. ◊ Leasing arranged by Leasing Group, Inc. In Canada and Mexico, configurations and prices may trade names are used to identify entities claiming the marks and names or their products. Dell Computer Corporation disclaims any proprietary interest in trademarks or trade names other than its own. ΔService provided Guarantee, limited warranty, and Xerox's Service Contract, please write to Dell USA Corporation, 9505 Arboretum Boulevard, Austin, Texas 78759-7299, ATTN: Warranty. ©1991 Dell Computer Corporation. All rights reserved.

Circle 75 on reader service card

**IT'S OKAY
TO PAY \$10,000
FOR AN i486
COMPUTER.**

**AS LONG AS
YOU
GET A \$5,500
REBATE.**

*Performance Enhancements. Within the first megabyte of memory, 96 KB of memory is reserved for use by the system to enhance performance. Can be optional. **All prices and availability subject to change without notice. Dell Computer Corporation is not responsible for errors in typography or photography. **Payment based on 36-month, open-end lease. © Leasing arranged by Finance Group, P.O. Box 1000, Dallas, TX 75201. All other trademarks are the property of their respective owners. Dell is a service mark of Dell Computer Corporation. i486 is a trademark of Intel Corporation. Windows is a trademark of Microsoft Corporation. © 1991 J.D. Power and Associates. Company website: <http://www.dell.com>. This advertisement may be used for promotional purposes. Responses from Business End Users at 1,784 business sites. Small to medium size businesses were based on the size of sales between 1 and 99 employees. See www.dell.com for more information. Small to medium size businesses.

If a penny saved is a penny earned, you could make about \$5,500 just by choosing the Dell 433P[®] over another

leading i486[™] system. The 433P comes with a

200MB hard drive, 4MB of RAM,* and a VGA Color Plus Monitor for just \$4,499.

Or you can choose the 80MB, 2MB of RAM version at \$3,999.

Either way, the Dell 433P comes with a high resolution video monitor making it ideal for Windows,[™] graphics and desktop publishing.

The service and support program is a bonus. According to a recent J.D. Power and Associates survey, Dell is the "Best Personal Computer in Customer Satisfaction in Small to Medium Size Businesses."SM Which was a huge honor, yet no big surprise considering we've also won PC Week's Corporate Satisfaction Poll an unprecedented 8 times now.

For us this means prestige, for you it means a reliable PC with the best service and support in the industry.

Take our toll-free technical support hotline, where 90% of reported problems are solved,

usually in 6 minutes or less.

And, our

innovative TechFaxSM line gives you system information 24 hours a day. Plus an electronic bulletin board lets you log in and see other users' questions with Dell's answers.

If these don't solve your problem, a trained technician can be at your desk-side usually by the next business day.^Δ This one year on-site service contract is included in the system price.

You get the credit. The Dell Direct Advantage MasterCard offers a credit limit up to \$15,000 and a way to earn points toward Dell

HERE'S THE SUPPORT YOU'LL GET.

- ~ Toll-free technical support hotline for the life of your system.
- ~ One full year of on-site service included in the system price.^Δ
- ~ Self-diagnostic software.
- ~ Toll-free 24-hour TechFax line for instant access to Dell technical information.
- ~ On-line Bulletin Board to communicate with Dell technical staff and other Dell users.

products with everything you buy.

A variety of financial products are also available that can be tailored to meet your business needs. For instance, you can lease[◇] the Dell 433P for as little as \$136 a month.

Call us. It's free. Just describe your needs and we'll help configure the right system for you, custom-build it, test it and ship

it to you. Each Dell system



comes with a 30-day no questions asked money back guarantee and one-year limited warranty.

So, order your Dell 433P today. You've earned it.



THE NEW DELL 433P 33 MHz i486 SYSTEM. SYSTEM INCLUDES VGA COLOR PLUS MONITOR, 80 MB HARD DRIVE, 2 MB RAM.*

nesses. J.D. Power and Associates is a service mark of J.D. Power and Associates. Other trademarks and trade names are used to identify the entities claiming the marks and names or their products. Dell Computer Corporation disclaims any proprietary interest in trademarks and trade names other than its own. ^ΔService provided by Xerox Corporation. On-site service may not be available in certain remote locations. Shipping, handling and applicable sales tax not included in the price. For information on and a copy of Dell's 30-day Total Satisfaction Guarantee, limited warranty, and Xerox's Service Contract, please write to Dell USA Corporation, 9505 Arboretum Boulevard, Austin, Texas 78759-7299, ATTN: Warranty © 1991 Dell Computer Corporation. All rights reserved.

Circle 75 on reader service card

NOTEBOOK COMPUTERS ARE INCREDIBLY LIGHTWEIGHT.

UNFORTUNATELY, SO IS MOST OF THEIR SERVICE AND SUPPORT.

Of course, this doesn't hold true when you're talking about the Dell® 320N. Sure, it's definitely light—a mere 6.4 pounds and it easily fits in your briefcase. But that's the only thing lightweight about it.

Service, service, and more service. You see, the Dell 320N comes with the service and support for which we've won PC Week's Corporate Satisfaction Poll for PCs, laptops and servers. An unprecedented 8 times.

And Dell has also just been ranked the best personal computer in J. D. Power and Associates' first ever Customer Satisfaction Index for PCs in Small to Medium Sized Businesses.SM

And if you need help, call our toll-free technical support hotline where 90% of reported problems are solved right over the phone, usually in six minutes or less. Or if you use our

innovative TechFaxSM line, we'll fax you back Dell system

information immediately. But if the

problem still isn't solved, a trained technician will be sent to your hotel room or office by the next business day.^Δ With a replacement system if necessary. And if possible, your hard drive contents will be transferred on the spot. The first year of on-site service is included in the price of your system.

Heavyweight features in a lightweight system. The Dell 320N comes with features you'd normally expect in a heavier laptop model. It has a 3.5" floppy drive, an extended travel keyboard with separate cursor keys (Home, End, Page Up, Page Down), special screen navigation keys, and a high quality VGA LCD. You can choose a 40 or 60 MB hard drive, an optional built-in fax modem, and it has a sliding door that lets you easily insert a math coprocessor or extra RAM modules.

You'll also get Dell's "Continuum

Power Battery System" which lets you replace the battery without leaving your software application

HERE'S THE SUPPORT YOU'LL GET:

- ~ Toll-free technical support hotline for the life of your system.
- ~ One full year of on-site service included in the system price.^Δ
- ~ Self-diagnostic software.
- ~ Toll-free 24-hour TechFax line for instant access to Dell technical information.
- ~ On-line Bulletin Board to communicate with Dell technical staff and other Dell users.

or turning off the system.

For sale, for lease, for less. When you call us, we'll help you decide on a perfect system and offer you a variety of financial products that can be tailored to meet your business needs. Every Dell system comes with a 30-day satisfaction guarantee. So if you aren't happy with it, you can return it for a full refund, no questions asked.

So give us a call today. And as

for the lightweight that's heavy on the service and support.

TO ORDER, CALL, PLEASE REFERENCE #11D42
800-626-4818
HOURS: 7 AM-9 PM CT MON-FRI. 8 AM-4 PM CT SAT.
IN CANADA 800-387-5752. IN MEXICO 95-800-010-0664.

DELL
COMPUTER
CORPORATION

*Performance Enhancements: Within the first megabyte of memory, 96 KB of memory is reserved by the system to enhance performance. Can be optionally disabled. All prices and specifications are subject to change without notice. Dell cannot be responsible for errors in typography or photography. **Payment based on 36-month, open-end lease. ^ΔLeasing arranged by Leasing Group, Inc. In Canada and Mexico, configurations and prices may vary. Dell is a registered trademark and TechFax is a service mark of Dell Computer Corporation. i386 is a trademark of Intel Corporation. 1991 J.D. Power and Associates' Computer End User Satisfaction Study: Phase I, Office Based Small to Medium Sized Businesses. Responses from Business End Users at 1,784 business sites. Small to medium size businesses were based on office sites with between 1 and 499 employees. Best Personal Computer in Office Based End User Satisfaction in Small to Medium Size Businesses. J.D. Power and Associates is a service mark of J.D. Power and Associates. Other trademarks and trade names are used to identify entities claiming the marks and names of their products. Dell Computer Corporation disclaims any proprietary interest in trademarks or trade names other than its own. Service provided by Xerox Corporation. On-site service may not be available in certain remote locations. Shipping, handling, and applicable sales tax not included in the price. For information and a copy of Dell's 30-day Total Satisfaction Guarantee, limited warranty, and Xerox's Service Contract, please write to Dell USA Corporation, 9505 Arboretum Boulevard, Austin, Texas 78759-7299, ATTN: Warranty. © 1991 Dell Computer Corporation. All rights reserved.



File Edit Display Help
Microsoft PowerPoint - FORECAST.PPT
File Edit View Style Text Draw Color Window Help

Monthly Sales Forecast

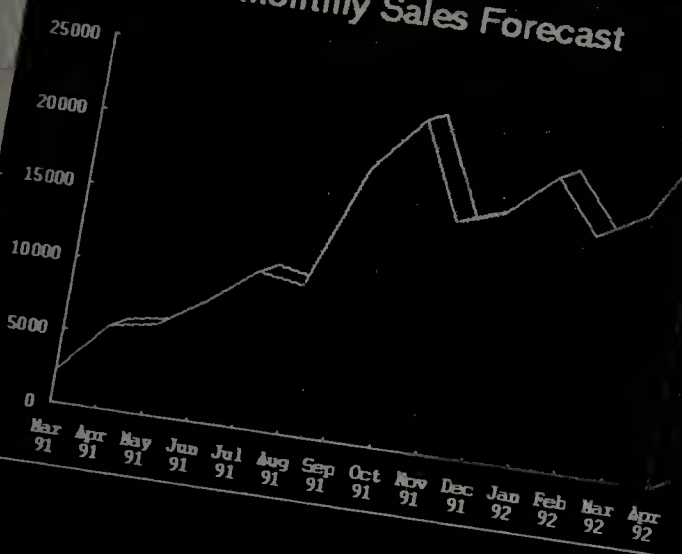

\$3399 Lease^o: \$127/Mo.**
The Dell 320N 20MHz i386™ SX
system includes VGA LCD,
40 MB Hard Drive, 1 MB RAM.

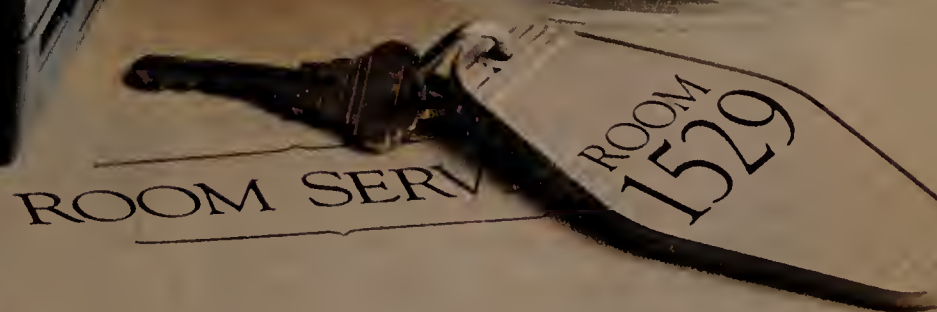

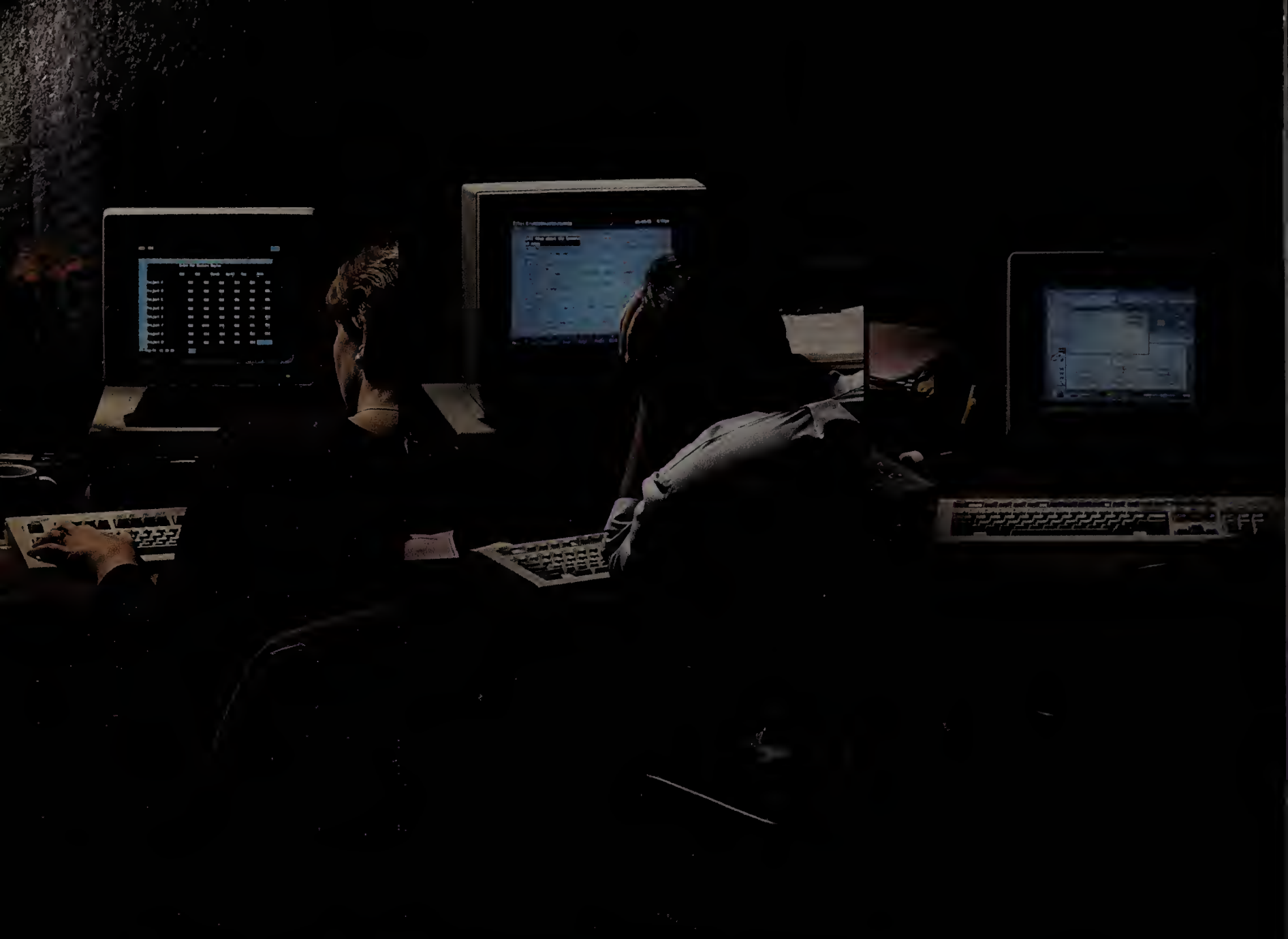

One Of The People Working Here Is Wearing Pajamas.

Now you can leave the office without a single disk and not even think about what you're going to work on until you switch on your home PC. At three in the morning. In your polka dot pj's.

You can take off on a trip with only a laptop and a change of underwear and be up and running on your office PC before the bellman hands you the key to the mini bar.

All you need is Central Point Commute™ from the makers of PC Tools™.

Commute™ is a new remote control software program that lets you access everything on your office PC from your home PC or laptop over a modem or Novell network. We're talking about actually taking control of your office PC from anywhere at anytime without getting in a car, on a plane, or off your bottom.

Commute lets you run DOS- and Windows-

based applications, transfer files, access E-Mail, and use the laser printer in your office. All with complete security.

And the hardest part of using Commute is opening the shrinkwrap on the package. There are simple pull-down menus, on-screen help, mouse support, even pictures on the screen to tell you what to do next.

For a limited time, you can buy Commute at the Special Introductory Price of only \$79, including a license for two computers. Or you can get Commute as part of new PC Tools 7.0. All you have to do is give us a call at 1-800-445-4132 for the name of the dealer nearest you and get down there.

Of course, you will have to get dressed.

\$79 SPECIAL LIMITED TIME OFFER.



Central Point Software INC.
Making Computing Safer, Simpler, Faster.

Central Point Commute, Commute and PC Tools are trademarks of Central Point Software, Inc. Names of other products mentioned herein are used for identification purposes only and may be trademarks and/or registered trademarks of their respective companies. Offer good in U.S. and Canada only.

Circle 52 on reader service card

UPDATE

New Versions of Your Favorite Products

Reduced Emissions Video Graphics Color Monitor



Compaq's new color monitor complies with the Swedish MPR 1990 electromagnetic emissions guidelines.

Compaq Computer has added a color monitor that complies with the latest Swedish electromagnetic emissions guidelines. The Reduced Emissions Video Graphics Color Monitor reduces extremely-low-frequency (ELF) emissions, very-low-frequency (VLF) emissions, and on-screen electrostatic potential. The 14-inch VGA monitor is

799, \$100 more than Compaq's standard Video Graphics Color Monitor. A \$299 Video Graphics Monochrome Monitor delivers the same emission reductions and replaces the existing monochrome monitor. Compaq Computer Corp., 20555 State Highway 249, Houston, TX 77070-2698; 713/370-0670.

Reader service no. 637

Microsoft Mail 2.1

WINDOWS After purchasing Consumer Software's *The Network Courier*, Microsoft added more flexible configurations and is making the upgraded product, retitled *Microsoft Mail*, available free through August 31 to all *Network Courier* users. A *Windows* program, *Microsoft Mail 2.1 for PC Networks* supports a wide array of messaging gateways, including one to

AppleTalk networks, and all users (not just network managers) can call product technical support. A *Microsoft Mail Server* with software for a post office, message transfer between servers, and remote user access is \$695. Workstation License Paks are available starting at 5 for \$395. Microsoft Corp., One Microsoft Way, Redmond, WA 98052-6399; 800/227-4679, 800/426-9400, 206/883-8101 (fax).

Reader service no. 634

Data Junction 4.0

This utility for converting data base, spreadsheet, word processing, and accounting data now recognizes more formats and offers more conversion options. The \$99 Standard Edition converts ASCII, *dBASE*, *1-2-3*, *askSam*, and *Q&A*, as well as *WordStar*, *Word*, and *WordPerfect* mail merge files. The \$199 Professional Edition adds *R:base*, *Paradox*, *DataFlex*, *DataEase*, *SuperCalc*, *Excel 2.x*, mainframe/binary/EBCDIC, *Btrieve*, and *c-tree* files. The Advanced Edition retails for \$299 and adds *Oracle*, *Informix*, and *C-ISAM* files. Upgrades for all of the versions cost \$69. Tools & Techniques, Inc., 1620 W. 12th St., Austin, TX 78703; 800/444-1945, 512/482-0976 (fax).

Reader service no. 635

ACT Network Version

A network version of Contact Software's *ACT 2.0* incorporates record locking so network users can share common contact data bases. The *ACT Network Version* lets you maintain private as well as public schedules for contacts and set your own data base defaults, menus, and field labels. But all users on a network can share common letters, memos, reports, and forms. *ACT Server Plus One* sells for \$595; the 5-user *ACT Network Version* sells for \$1295. Stand-alone users can upgrade to the server version for \$445 and to the 5-user pack for \$995. Software Int'l, 1625 W. Crosby Rd. #132, Carrollton, TX 75006; 214/418-1866.

Reader service no. 639

Expense It 2.0

This version of *Expense It* lets you share your expense report data with several popular accounting systems, including *DacEasy* and *Quicken*, as well as take data down from the Sharp Wizard pocket organizer. Data transfer is made possible by *Expense It's* multiple General Ledger code assignments for each expense. The program lets you add expenses in any order and print to its standard expense form or your company's form. On the Go Software, 330 Washington St. #400, Marina Del Rey, CA 90292; 800/252-9955, 213/578-2095 (fax).

Reader service no. 638

The Complete Communicator 2.6

Version 2.6 of *The Complete Communicator*, a communications hardware/software combination, simplifies installation of the fax/modem/voice-mail board and supports high memory to facilitate background faxing. You can scan and send legal-sized documents and include logos and signatures in faxes. A copy of the *Microsoft Works* integrated productivity program is bundled with the \$699 board; upgrades are available for \$49. The Complete PC, 1983 Concourse Dr., San Jose, CA 95131; 408/434-0145, 408/434-1048 (fax).

Reader service no. 640

For more information about any product, contact the manufacturer or circle the number on the reader service card. ☺

Screen Gems: Super-VGA Boards

Select the right souped-up VGA board from the ten reviewed here, and enjoy a sharper, flicker-free image with a magnitude more colors.

TJ Byers

Whether you're tired of your old monochrome display or you're finding plain EGA or VGA too confining, now is the perfect time to upgrade your display system to super VGA. For just a few hundred dollars, a new display board can dramatically improve the look of your screen and take the strain off your eyes by reducing screen flicker.

At all-time low prices, most of today's video boards can give you more pixels than plain VGA's 640 across by 480 down. What makes super-VGA boards super is their two extra modes, 800 by 600 and 1024 by 768. With these higher resolutions, *Windows* will be able to fit more windows on the same monitor, and spreadsheet users can view more cells with less scrolling. And wait till you feast your eyes on graphics at 1024 by 768 with 256 colors—they're not photograph quality, but they come remarkably close.

The only drawback to running applications at these higher resolutions is slower performance. But unlike the last generation of super-VGA boards, this batch sacrifices remarkably little speed—typically less than 10

percent—a trade-off that most users seem perfectly willing to live with.

Many super-VGA boards offer another bonus: ergonomic benefits in the form of reduced flicker. Much of the eyestrain and fatigue you feel after staring at the screen for long periods can be traced to flicker from two sources—slow *refresh* and *interlaced scanning*. Refresh refers to the number of screens the board draws per second; the more the better. Interlaced scanning—which is an issue only at 1024 by 768—is a cost-saving technique that unfortunately increases sensitivity to flicker.

Many super-VGA boards provide noninterlaced scanning and a screen refresh rate of 70 or 72 Hz—an eye-pleasing combination that can increase productivity. If your monitor supports these enhancements, you'll notice the benefits immediately. Even if it doesn't, since these features add virtually nothing to the price, we recommend selecting a board that offers them should you switch to a better monitor (see the sidebar "Make Your Monitor Flicker Free").

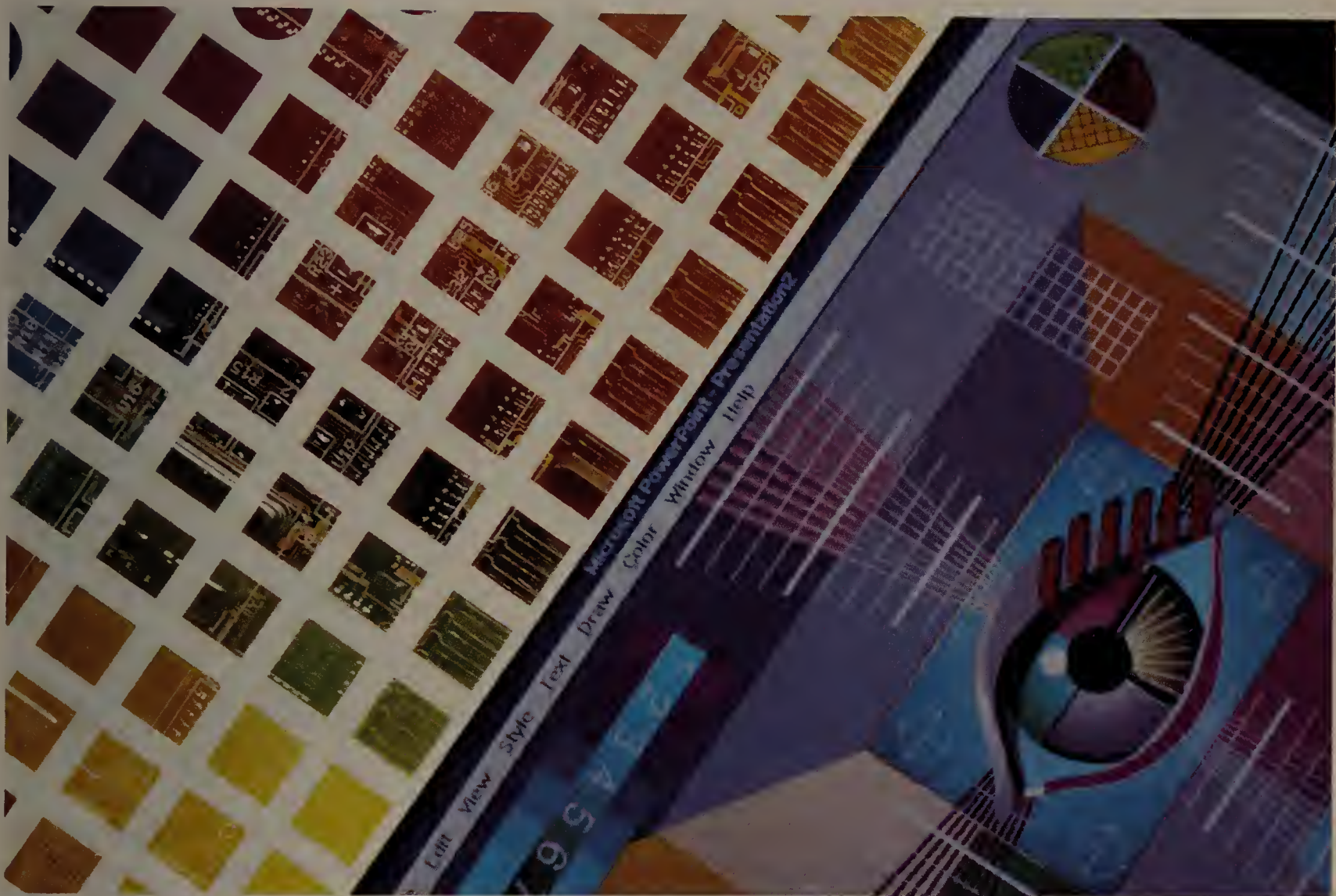

Getting Beyond VGA

The secret to super-VGA resolutions and colors lies in the software drivers that come with each board. A driver enables a board to work with a specific application at a fixed super-VGA resolution; you need a separate driver for each application and each super-VGA mode. Without one, you're stuck with plain old VGA.

Most of the boards reviewed here provide an excellent selection of super-VGA drivers for the most popular business applications, including *1-2-3* and *Windows*. The advantage for *Windows* users is loading only one 800 by 600 or 1024 by 768 driver to run all *Windows* apps at that resolution. For text applications, most boards also have a 132-column mode, giving you more work space.

You can install a super-VGA board in virtually any PC, but some boards make the job easier than others. Those that force you to set jumpers or DIP switches are the most difficult. If you're upgrading from a monochrome display or if your PC has built-in VGA, you may have to set DIP switches or jumpers on the PC's motherboard too. However, walk-through instructions in each

board's manual take much of the sting out of installing the hardware. In most cases, you can plug and play, but only two boards—ATI's VGA Wonder XL and Boca's SuperVGA—can promise that for any situation.

To help you select the best super VGA at the lowest price, we probed and prodded ten super-VGA boards. We checked out their screen flicker and benchmarked them for performance. In the speed tests, we found little to differentiate between the boards at 640 by 480 resolution, so we confined our benchmarks to 800 by 600 and 1024 by 768. Even then, only the *AutoCAD* tests—and to a lesser degree the *PowerPoint* tests—split up the pack. We also assessed the boards' ease of installation and the manufacturers' warranty and support.

We were pleasantly surprised to find that the software compatibility problems that beset earlier super-VGA boards were no longer in evidence. Two of the boards in this roundup, the ATI VGA Wonder XL and the Boca SuperVGA, merit a Best Buy. A couple of other boards are notable smart buys, and as a whole it's hard to go wrong.

Super VGA: The Eyes Have It

Super-VGA boards give you two extra-sharp resolutions and 256 colors instead of 16. To take advantage of these enhancements, the board you buy must include software that specifically supports the application you want to use.

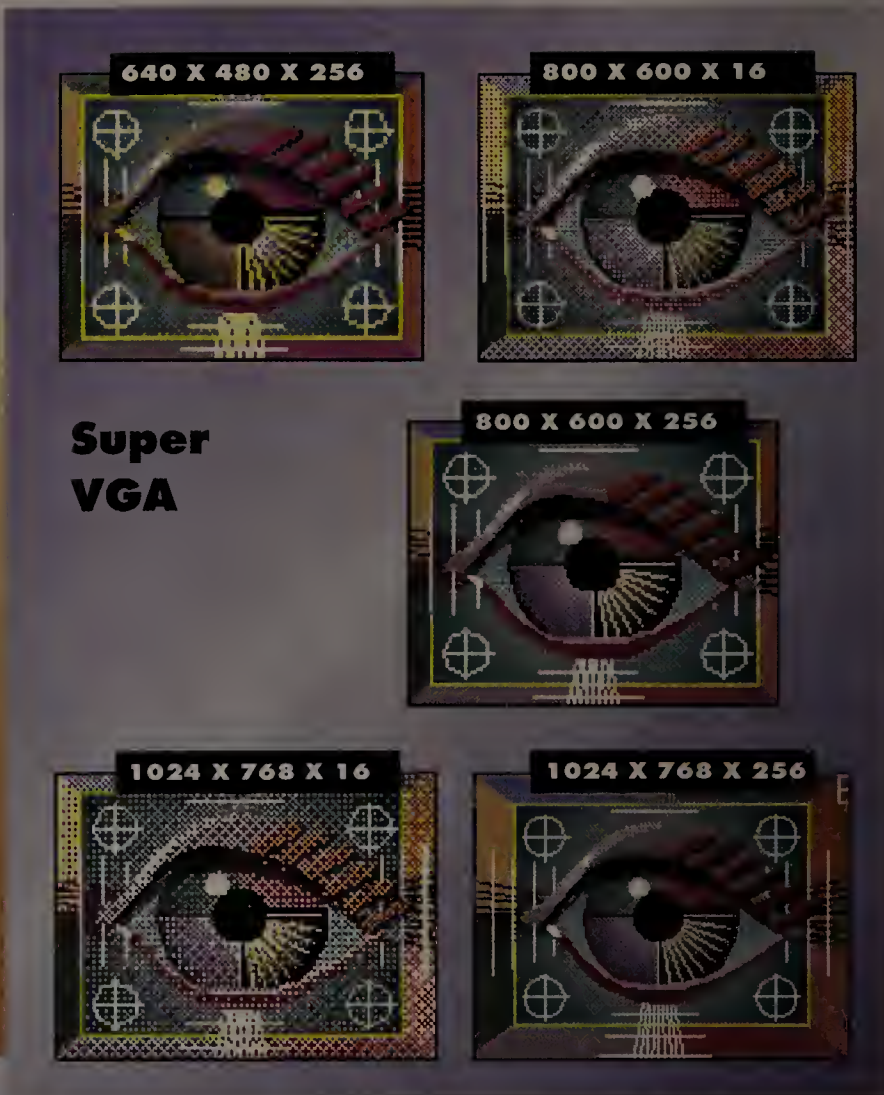

ATI VGA Wonder XL



PROS: Switchless setup, menu-driven software installation, mouse included
CONS: Middle-of-the-road performance

With menu-driven hardware and software driver installation, the ATI VGA Wonder XL is the easiest board to install and configure. Furthermore, it comes with a mouse port and a three-button mouse yet sells for a mere \$259 on the street with 512K of RAM—making it a clear Best Buy.

The VGA Wonder XL is the only board in this roundup to provide flicker-free 72-Hz screen refresh at all resolutions, even with a large, expensive, flicker-free monitor.

If you use *PowerPoint* or *AutoCAD*, however, you might want to consider a faster board. In our *PowerPoint* speed tests, the VGA Wonder XL fell far back

in the field. In the *AutoCAD* benchmarks, it consistently ran in the middle of the pack.

The ATI VGA Wonder XL is an excellent board to have around as flicker-free high-resolution monitors get cheaper. It's a truly switchless board and has the smoothest driver installation of the bunch—a boon for those who frequently switch between DOS applications. It's a distinct Best Buy, especially if you don't already have a mouse.

Boca SuperVGA



PROS: Lowest price, switchless hardware installation
CONS: Menuless driver installation

With a street price of \$160 with 512K of RAM, Boca's SuperVGA is the bargain of the roundup. Even at this price, the board doesn't skimp on drivers, and it's

the only one besides the ATI with switchless installation.

The SuperVGA delivers flicker-free 72-Hz screen refresh at all resolutions except 1024 by 768. This makes the board a cost-effective match for top-quality 14-inch multiscan monitors that can run at 72 Hz at 800 by 600, such as Seiko's CM 1440.

As with the ATI, you can plug and play the SuperVGA—even on a networked machine. Without its rival's menu-driven driver installation, however, switching between DOS applications in extended modes will require a bit more work.

For a board with the lowest price in town, the SuperVGA shows a lot of spunk and sparkle. It was a bit faster than the ATI in the *AutoCAD* tests, hardware installation is just as easy, and it even comes with a five-year warranty. Unless you plan to buy an expensive monitor that's flicker free at 1024 by 768, this is the Best Buy board for you.

Buying Smart

Good news! Unlike the VGA boards of yore, today's super-VGA boards seem devoid of serious compatibility problems with either hardware or software. They're also considerably faster. If you want to use high-resolution super-VGA modes, though, the board you buy must specifically support the application you use.



SOFTWARE SUPPORT

Without a special super-VGA software driver for your application, you'll see that application at standard 640 by 480 VGA resolution with 16 colors. All the super-VGA boards in this review come with drivers that enable them to run at the two super-VGA resolutions—800 by 600 and 1024 by 768—with *Windows*, *1-2-3*, *AutoCAD*, *WordPerfect*, and *Ventura*. Other boards add support for *Word*, *WordStar*, *OS/2*, and more. Make sure the board you buy has the driver you need.

Colors are just as important as a sharp image, and whether you get 16 or 256 depends on the driver and the amount of RAM on board. If you have a graphics-intensive task in mind—say, previewing a color slide in *PowerPoint* or working with more than 16 layers in *AutoCAD*—a 256-color image at a full 1024 by 768 may be in order. To get that many colors at that resolution, you'll need 1MB of RAM—and some boards hold no more than 512K.

Note that super-VGA life is easiest under *Windows*. Load a single super-VGA *Windows* driver, and that's it. Along with the environment itself, all *Windows* applications benefit from the enhanced resolution and colors.



FLICKER-FREE SUPPORT

The latest, greatest feature of these boards is flicker-free operation. Standard VGA boards drive a monitor at 60 screens per second (or 60 Hz), creating a perceptible flicker. You can plug all but one of these boards into a standard multiscan such as the NEC MultiSync 3D and run the monitor in standard VGA resolution at 70 or 72 Hz. That's fast enough to prevent most users from noticing the flicker, making the screen easier on the eyes.

The same boards that give you flicker-free operation at standard VGA resolution can also offer that performance at 800 by 600—but for that you need a better multiscan, such as Seiko's CM 1440. Monitors of this type also perform 60-Hz noninterlaced scanning at 1024 by 768. Noninterlaced scanning reduces the user's ability to perceive flicker—but at 60 Hz, it's still noticeable.

Only the ATI VGA Wonder XL and the Genoa SuperVGA 6400A offer true flicker-free performance at 1024 by 768. You have to spend at least \$1000 on the street to buy a monitor that can give you that. But by the end of this year, the price for monitors in this class may come down. Look for flicker-free performance at 1024 by 768 if you see a top-of-the-line monitor in your future.



EASE OF INSTALLATION

Ideally, installing a super-VGA board should be a plug-and-play operation. The ATI VGA Wonder XL and the Boca SuperVGA sense your hardware configuration and basically install themselves. But most boards require that you flip a couple

of DIP switches or move a jumper, depending on whether a network board is present, how much RAM is installed, whether you opt for flicker-free performance, and so on.

Once you've installed the card, you need to install a separate driver for each application you want to use at super-VGA resolution. If you plan to soup up several applications, you'll need to switch drivers frequently; look for a board that offers menu-driven driver installation.



PERFORMANCE

We found little speed difference between boards with most of the applications we tested. The exceptions were in the *AutoCAD* and *PowerPoint* benchmarks. If you plan on using either of these applications, pay close attention to the two tests.

The biggest performance variance shows up between modes rather than between boards. Expect about a 10 percent performance hit when you upgrade from standard VGA resolution to 800 by 600, and an additional 5 percent when you switch to 1024 by 768. With an application like *PowerPoint* that actually uses 256 colors, expect another 5 percent slowdown in any mode when you switch from 16 to 256 colors.



SERVICE AND SUPPORT

Access to new drivers is a prime service issue for most super-VGA users. Being able to download the latest versions from an electronic bulletin board service is a great benefit. For installation problems, toll-free tech support is a big plus, and technical fax support is helpful for quick-fix answers.

Everex Viewpoint VRAM

PROS: Excellent Windows performance

CONS: Expensive; difficult installation

The Everex Viewpoint VRAM is harder to install and configure than most boards. Combine this with a \$392 street price—the highest in the roundup—and you'll wonder whether the board's fast *PowerPoint* and *Excel* performance make the Viewpoint an appealing purchase.

One way of curbing the board's high price is to buy it configured with ordinary RAM instead of video RAM (VRAM); this can save you either \$100 (for 512K) or \$200 (for 1MB). The trade-

off is a slight decrease in speed.

Installation can be difficult for two reasons: You have to install software drivers without a menu, and you may need to set both DIP switches and jumpers. Even when you follow the manual's instructions, you may need to make additional changes. During testing we had to reconfigure a hard disk controller card before the system would boot. Fortunately, the company's toll-free technical support proved extremely helpful.

It's unfortunate, though, that calling Everex's 800 number may be necessary. High price and potentially tricky installation make the Viewpoint less appealing than many.

Genoa SuperVGA 6400A

PROS: Flicker-free operation in all modes

CONS: No 1MB version, one-year warranty

The Genoa SuperVGA 6400A goes for a moderate \$248 on the street and offers flicker-free 70-Hz screen refresh all the way up to 1024 by 768. With a RAM limit of 512K, however, you can enjoy that resolution with only 16 colors.

A growing number of *Windows* applications use 256 colors, allowing you to preview color slides and run monitor-based presentations. You can get 256 colors from this board—but only if you never go beyond 800 by 600. As for performance, the board fell well below the

Make Your Monitor Flicker Free

Eric Knorr

You've been staring at the screen for hours. Your eyes are so tired, the image on your monitor seems to be flickering. Well, guess what? It is.

Standard VGA monitors take one-sixtieth of a second to create a complete image of 480 lines. That may sound fast, but it's not quite fast enough to fool your eyes into seeing a perfectly stable image.

You probably wouldn't notice flicker on a screen displaying 60 screens per second (or 60 Hz) of text on a black background. But with a light background—typical of so many *Windows* applications—you can see it. Even if you don't notice, the flicker affects your eyes, causing them to strain and tire over time.

Studies show that the faster the screen refreshes, the fewer people sense flicker. Most of the super-VGA boards in this review can drive a monitor at either 70 or 72 Hz—welcome news for sore eyes.

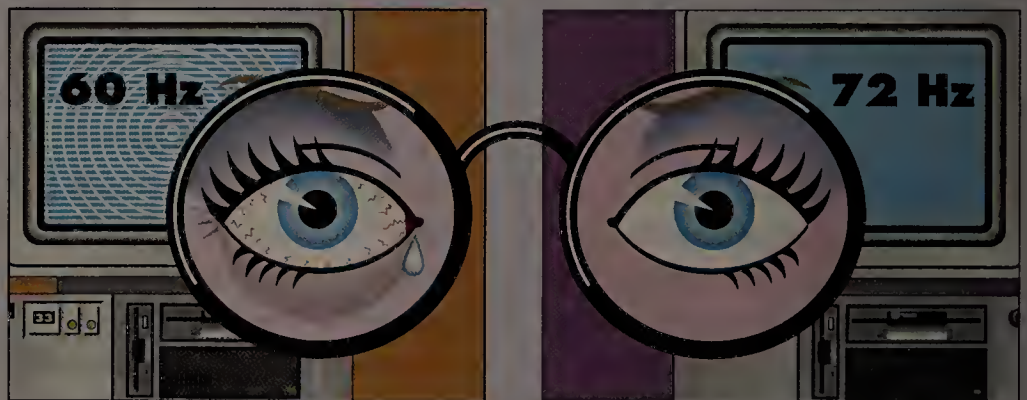

You need the right monitor to take advantage of a super-VGA board's flicker-free performance. A standard VGA monitor won't do—it's fixed at 60 Hz. But many of today's color monitors are *multiscans*, which means their screen can be scanned at any speed within a given range. For example, any multiscan, including NEC's ever-popular Multi-Sync 3D, can be driven at 70 or 72 Hz at standard VGA resolution, 640 by 480. Many newer multiscans—not the 3D, however—can also run flicker-

free at 800 by 600.

If you want flicker-free performance at the top super-VGA resolution, 1024 by 768, be prepared to pony up some big bucks for the monitor. Fortunately, support for 70 or 72 Hz at any resolution costs next to nothing on the board side (the ATI VGA Wonder XL and the Genoa SuperVGA 6400A are the only boards reviewed to offer flicker-free operation at 1024 by 768). Better, the cost of high-resolution, flicker-free multiscans promises to plummet in the near future.

FEATURES EVALUATION

Super VGA: A Sharper Image for Less

Enjoy high resolution and up to 256 colors—provided the board you buy supports your application. The chart below shows resolution and colors for each.

	ATI VGA Wonder XL ¹	Born SuperVGA	Everex Viewpoint VRAM	Genoa SuperVGA 6400A	Orchid ProDesigner II	Paradise VGA 1024	SigmaVGA Legend	STB PowerGraph Ergo-VGA	Trident Impact III	Video Seven VRAM II
Standard features										
Street price ²	\$259	\$160	\$392	\$248	\$304	\$254	\$253	\$201	\$172	\$370
List price ²	\$349	\$195	\$499 ³	\$272	\$469	\$469	\$375	\$265	\$229	\$499
Mouse port	●	●	○	○	○	○	○	○	○	○
Software support (colors available with maximum RAM installed)										
Windows 3.0										
640 x 480	256	256	256	256	256	256	256	256	256	256
800 x 600	256	256	256	256	256	16	256	256	256	256
1024 x 768	256	256	256	16	256	16	256	256	256	256
Ventura (GEM)										
800 x 600	16	16	16	16	16	16	16	16	16	16
1024 x 768	16	16	16	16	16	16	16	16	16	16
1-2-3										
800 x 600	0	0	0	0	0	16	16	0	0	16
1024 x 768	0	0	0	0	0	0	16	0	0	0
132 columns	16	16	16	2	16	16	16	16	16	16
WordPerfect										
800 x 600	16	256	16	16	16	0	16	256	16	16
1024 x 768	16	256	16	16	16	0	16	256	16	16
132 columns	16	256	16	0	16	16	16	16	16	16
AutoCAD										
640 x 480	256	256	256	16	256	16	256	256	256	16
800 x 600	256	256	256	16	256	16	256	256	256	16
1024 x 768	256	256	256	16	256	16	256	256	256	16
Flicker-free support										
At VGA resolution	●	●	●	● ⁴	●	○	●	●	●	●
At 800 x 600 resolution	●	●	●	○ ⁴	●	○	●	●	●	●
At 1024 x 768 resolution	●	●	○	○ ⁴	○	○	○	○	○	○
Ease of installation										
Switchless setup	●	●	○	○	○	○	○	○	○	○
Menu-driven software driver installation	●	●	○	○	○	○	●	○	○	●
Service and support										
Warranty (years)	2	5	2	1	4	3	1	2	2	7
Toll-free tech support	●	●	●	●	●	○	○	●	●	●
Daily support (hours)	8.5	8.5	11	9	9	9	9	10	10	9
Drivers through BBS	●	●	●	●	●	●	●	●	●	●
Fax tech support	●	●	●	●	●	●	●	●	●	●
	BEST BUY									

¹ The VGA Wander XL's predecessor, the VGA Wander, was a World Class Award in 1989 and 1990. The current model includes mouse.

² With 512K RAM.

³ With VRAM installed; \$399 with RAM installed.

⁴ Supports 70-Hz refresh at this resolution.

PC WORLD TEST REPORT

High Speeds for High Resolution

At standard VGA resolution, the boards reviewed showed few speed differences—they all did well. Even at 1024 by 768 and 800 by 600, the only real point spread showed up in the AutoCAD tests.

■ Best Buy

1024 x 768 resolution with 16 colors

AutoCAD 10

STB		581
Orchid		584
Baca		588
Everex		620
ATI		640
Sigma		652
Video Seven		682
Genaa		809
Trident		821
Paradise		915

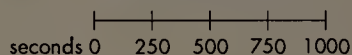

Excel 3.0

Video Seven		70
Everex		72
STB		72
ATI		73
Baca		73
Orchid		73
Sigma		73
Paradise		74
Trident		76
Genaa		77

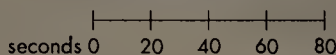

PowerPoint 2.0

Video Seven		67
Everex		68
Paradise		71
Genoa		74
Sigma		74
STB		74
Baca		75
Orchid		75
ATI		78
Trident		79

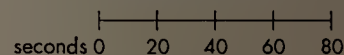

1024 x 768 resolution with 256 colors

AutoCAD 10

Orchid		584
STB		585
Baca		589
Everex		616
Sigma		637
ATI		640
Trident		701
Genoa		n/a*
Paradise		n/a*
Video Seven		n/a*

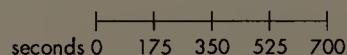

Excel 3.0

Video Seven		80
Baca		82
Sigma		82
STB		82
Everex		84
Orchid		84
Trident		86
ATI		87
Genaa		n/a*
Paradise		n/a*

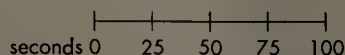

PowerPoint 2.0

Video Seven		71
Everex		74
Trident		77
Baca		78
Orchid		78
Sigma		78
STB		78
ATI		84
Genaa		n/a*
Paradise		n/a*

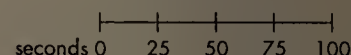

800 x 600 resolution with 16 colors

AutoCAD 10

STB		577
Orchid		579
Boca		585
Everex		607
ATI		639
Sigma		644
Video Seven		681
Trident		790
Paradise		899
Genaa		909

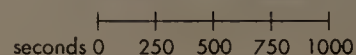

Excel 3.0

Everex		68
Video Seven		68
ATI		69
Sigma		69
Paradise		70
Baca		71
STB		71
Trident		71
Genaa		72
Orchid		72

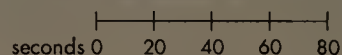

PowerPoint 2.0

Paradise		63
Video Seven		64
Everex		65
Sigma		65
ATI		67
Baca		67
Orchid		67
STB		67
Trident		70
Genaa		71

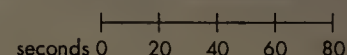

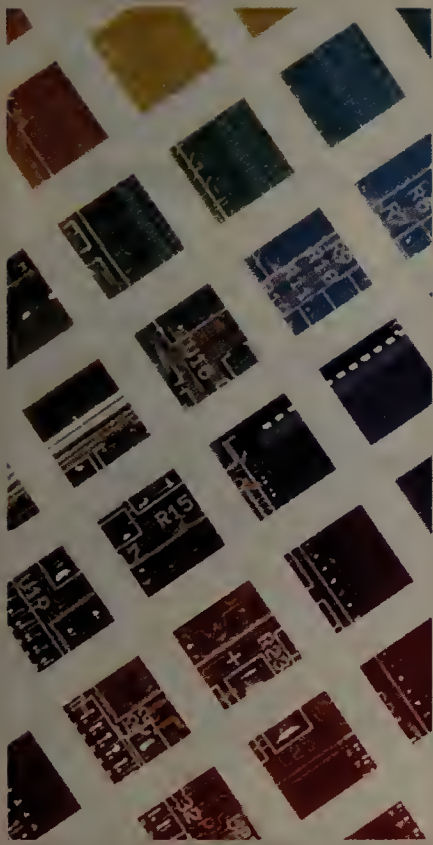

* No driver was supplied for this resolution and color level.

Methodology

We installed and tested the boards in a 20-MHz Compaq Deskpro 386/20e with 4MB RAM, on 80387 coprocessor, and a 110MB hard disk; we used an NEC MultiSync 5D display. In our performance benchmarks, we executed batch files using *AutoCAD 10* scripts, *Excel 3.0*, and *PowerPoint 2.0*. Timing began when the macro or script was launched and ended when it was completed. We tested the boards in the following modes: 1024 by 768 resolution with 16 colors, 1024 by 768 resolution with 256 colors, and 800 by 600 resolution with 16 colors.

AutoCAD 10

We draw, redraw, zoom in on, pan right, pan left, and zoom out of three separate DWG files.

Excel 3.0

We load a file, scroll ten vertical pages, jump to cell C5, change a value, and recalculate the worksheet. Then we open the graph associated with the worksheet, maximize it, wait 3 seconds to simulate viewing time, switch back to the worksheet, send the cursor to the top of the worksheet, and quit.

PowerPoint 2.0

We launch a typical *PowerPoint 2.0* session, in which we load a series of four slides, scroll through them, and then jump back to the first slide.

Data based on tests designed and conducted by the PC World Test Center. All rights reserved.

mean in both the *AutoCAD* and *PowerPoint* tests.

At 70 Hz, the SuperVGA 6400A displays two screens fewer per second than 72-Hz boards. But unless you have oscilloscopes for eyes, you won't notice the difference.

Genoa's warranty expires after one year, and the SuperVGA 6400A's speed won't thrill you. Flicker-free performance across all modes is this board's main selling point. If you want a flickerless 1024 by 768 image from a 16-inch monitor such as NEC's MultiSync 4D, this board and the ATI VGA Wonder XL are your only choices.

Orchid ProDesigner II

PROS: Fast *AutoCAD* performance

CONS: Expensive

The most outstanding feature of the Orchid ProDesigner II is speed—it tied for first place in the key *AutoCAD* tests. Other than that, the board has an average set of features and a fairly high \$304 street price.

Like most boards in this roundup, the ProDesigner II offers flicker-free 72-Hz performance at all resolutions except 1024 by 768. That may limit your options, but on today's 14-inch multiscreens, most people won't experiment beyond 800 by 600 anyway.

The board isn't quite plug and play, but unless a network board is present, you probably won't have to mess with the board's handful of jumpers. Driver installation involves issuing commands from the DOS prompt instead of simply choosing menu options.

Thanks to its speedy performance, *AutoCAD* users may want to consider this board seriously. In addition, by the time you read this, Orchid will be shipping a new version of the ProDesigner II (the IIs) that will list for \$120 less and purportedly will offer the same speed, 70-Hz refresh at 1024 by 768, and a special upgrade that will support over 32,000 colors under *Windows*. These

new features should make the ProDesigner IIs one of the hottest super-VGA boards around.

Paradise VGA 1024

PROS: Easy hardware setup

CONS: No 1MB version, no flicker-free modes, slow *AutoCAD* performance

Like the Genoa SuperVGA 6400A, the Paradise VGA 1024 tops out at 512K—and at \$254 on the street, it sells for about the same price. It's the only board in the roundup that won't refresh the screen at 70 or 72 Hz in any mode.

The board is easy enough to install; there are no jumpers to set, just two DIP switches. However, switching drivers could be simpler—you have to do it from the DOS prompt instead of from a menu.

The board includes drivers for all the usual applications, but the memory cap means you won't find any 256-color drivers for 1024 by 768 operation—a disappointment if you're a business graphics user interested in previewing slides. Furthermore, compared with the other entries, this board performs slowly with *AutoCAD*.

For beyond-VGA graphics, the Paradise VGA 1024 falls short. You can do better for less.

SigmaVGA Legend

PROS: Easy driver installation

CONS: One-year warranty

The SigmaVGA Legend has two things going for it: menu-driven driver installation and the second-largest assortment of software drivers in the roundup. Its shortcoming is a scant one-year warranty.

The Legend is one of three boards reviewed that have easy, menu-driven driver installation. And while hardware installation isn't completely switchless, it comes close. The only jumpers you have to set are for the 72-Hz screen

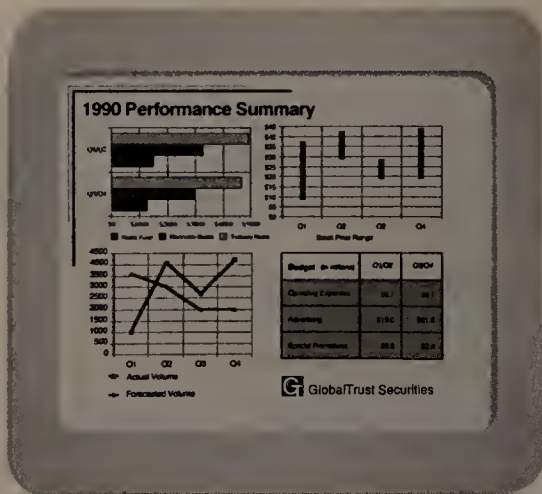

Additions to Marketing Department

- Sales and advertising managers haven't changed from prior department structure
- Promotion spot has yet to be filled
- Sales manager is in process of making assignments
- Market development person starts next month
- Organizational changes are effective January 1

GlobalTrust Securities

1990 Accomplishments

- Increased market share to 59%
- Concluded Canadian merger
- Expanded Eurobond Fund accounts by 37%
- Successfully opened three new branches

GlobalTrust Securities

National Sales Meeting Notes

1991 Sales Projections

Marketing Costs for Consumer Products

GlobalTrust Securities

1991 Network Expansions

GlobalTrust Securities



Additions to Marketing Department

Director of Marketing

- Sales Manager
 - Corporate
 - Retail
- Advertising Manager
 - Direct Mail

GlobalTrust Securities

1991 Investment Programs

- Bond Trading Seminars
 - Targeted at new accounts in Europe and Asia
- Financial Planning Direct Mail
 - Directed at customer base
 - Focused on retirement strategies

GlobalTrust Securities

Get people to see things your way.

Introducing New Aldus Persuasion for Windows.

No other presentation software is as automatic as new Persuasion® 2.0 from Aldus. But what exactly do we mean by automatic?

Let us explain the three easy steps. Step 1: Pick one of 55 pre-designed AutoTemplates. Step 2: Put your thoughts into the built-in outliner; Persuasion instantly formats your outline into fabulous finished visuals. Step 3: Now print overheads,

speaker notes or hand-outs. Or output 35mm slides. That's it.

Yet, Persuasion doesn't stop there. It's such a complete business tool that it also includes

word processing, drawing tools, charting and graphing capabilities. Plus, it allows you to import word processing, spreadsheet, graphic, and CGM files.

With a combination of features like these, you

can easily customize or create your own presentations. And the Windows environment makes it all easy for you to learn and use.



For a free demo disk or a \$9.95 video,* call (800) 333-2538, Dept.33N

Once you do, you'll want to call on the powers of Persuasion 2.0 every day for any type of meeting—

formal or informal. Something the users of our award-winning Macintosh version have done for years.

So call today for a free demo disk or a \$9.95 video* and see how success with new Persuasion 2.0 is automatic.



The Creative Edge
in Business

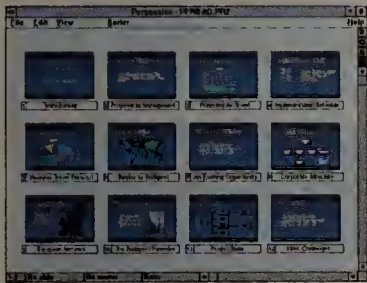

Arrange the flow of your presentation with the on-screen slide sorter.

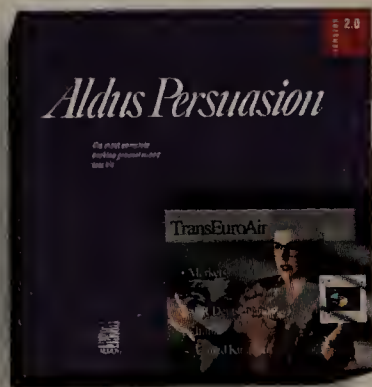

Automatically.

refresh (which tops out at 800 by 600) and the interrupt jumper (if the board coexists with a network card).

Two things may limit this board's longevity. First, it's one of two boards that come with only a one-year warranty. Second, it won't support flicker-free 72-Hz refresh at 1024 by 768. When new low-cost 72-Hz monitors emerge, you won't be able to take full advantage of them.

All factors considered, this board falls squarely in the middle of the pack. Easy software and hardware installation and a moderate price earn the Sig-

maVGA Legend a solid recommendation. At press time, Sigma announced the Legend II, which promises faster operation as well as more colors or faster screen refresh rates for its various resolutions.

STB PowerGraph Ergo-VGA

PROS: Low price, fast AutoCAD performance

CONS: Menuless driver installation

At a street price of \$201 with 512K of RAM, STB's PowerGraph Ergo-VGA is

one of the three least expensive boards reviewed. It's an attractive buy, offering both fast performance and nearly switchless installation.

The PowerGraph tied for first place in the *AutoCAD* tests. CAD performance hounds should note that this board lists for \$200 less than Orchid's equally speedy ProDesigner II.

As with the SigmaVGA Legend, you may have to move a jumper or two: one for 72-Hz screen refresh at 800 by 600, and the other to avoid conflicts with your network card. When you install drivers, there are no menus; you must do so from

EXECUTIVE SUMMARY

Looking Good Across the Board

The latest super-VGA boards offer sharp, flicker-free images and plentiful colors.



No need to settle for the standard VGA image. At very reasonable prices, all the boards here offer extended resolutions of 800 by 600 and 1024 by 768, and many offer 256 colors at all resolutions. Most also raise the number of screens per second from 60 to 70 or 72, reducing flicker and eyestrain. Best Buys **ATI VGA Wonder XL** and **Boca SuperVGA** combine ease of installation with flicker-free performance and good prices. The **Video Seven VRAM II** and the **STB PowerGraph** also make attractive buys.

	ATI VGA Wonder XL	Boca SuperVGA	Everex Viewpoint VRAM	Genoa SuperVGA 6400A	Orchid ProDesigner II	Paradise VGA 1024	SigmaVGA Legend	STB PowerGraph Ergo-VGA	Trident Impact III	Video Seven VRAM II
Software support	Excellent	Excellent	Excellent	Fair	Excellent	Fair	Excellent	Excellent	Excellent	Good
Flicker-free support	Excellent	Good	Good	Excellent	Good	Poor	Good	Good	Good	Good
Ease of installation	Excellent	Excellent	Fair	Good	Good	Good	Good	Good	Good	Good
Performance	Good	Good	Excellent	Fair	Excellent	Fair	Good	Good	Fair	Excellent
Service and support	Good	Excellent	Good	Fair	Excellent	Good	Fair	Good	Good	Excellent
Price	Excellent	Excellent	Poor	Good	Fair	Good	Good	Excellent	Excellent	Poor
Overall value	Excellent	Excellent	Good	Good	Good	Fair	Good	Good	Good	Good
	BEST BUY	BEST BUY								
Reader service no.	748	749	750	751	752	753	754	755	756	757

How we rate super-VGA boards

We rate these boards based on information in the Features Evaluation and the PC World Test Report, combined with our opinions of quality, reliability, and user benefit.

Software support refers to the number and type of drivers that came with a board. To rate an Excellent, a board must provide drivers for Windows, 1-2-3, WardPerfect, Ventura (GEM), and AutoCAD, with 256 colors in AutoCad and Windows.

Flicker-free support is based on the overall screen benefits a board offers. To garner an Excellent rating, a board must provide at least 70-Hz screen refresh. As the quality of the screen image

and the speed of the refresh drop, so does the rating. Boards that have neither 70-Hz or better screen refresh nor noninterlaced scanning rate a Poor.

Ease of installation applies to both hardware and software setup. Totally switchless installation merits an Excellent. To win a Good, a board must require that you change settings only in unusual circumstances, such as when a network board is present. A Fair rating is awarded when hardware conflicts between the video board and the PC are not covered in the documentation.

Performance is derived from benchmark results. With business and Windows applications, these boards show little difference in speed, except in the

AutoCAD and PowerPaint tests. An Excellent rating goes to those boards that perform well in both tests.

Service and support includes the length of warranty, the availability of tech support, and other support services. A board that has a BBS with program driver updates, a warranty of four years or more, and fax tech support earns an Excellent rating.

Price ratings are based on street prices, which were determined from an extensive phone survey of dealers.

Overall value is a weighted summary of all the above criteria, with emphasis on software support, flicker-free support, and ease of installation.

the command line.

If you use *AutoCAD* and you're looking for a fast VGA board at a bargain price, the PowerGraph is an excellent choice.

Trident Impact III

PROS: Low cost, widest software support

CONS: Slow performance

The Trident Impact III costs only \$12 more on the street than the rock-bottom Boca SuperVGA. Amazingly, for that low \$172 price, you get the widest selection of drivers in the roundup.

Trident provides 132-column drivers for *Word* and *WordStar*, plus 256-color drivers in all super-VGA resolutions for both *Windows* and *AutoCAD*. You don't get a menu for swapping drivers, though, and hardware installation isn't switchless.

The board's speed could be better. In most of the key performance benchmarks, the Impact III hovered in the bottom third.

If you like the idea of 132-column word processing in *Word*, this board is your best choice. Otherwise, bargain hunters would do better to opt for the superior performance, switchless installation, and even lower price of the Boca SuperVGA.

Video Seven VRAM II

PROS: Top Windows performance, easy software installation

CONS: Expensive, no 256-color AutoCAD drivers

The Video Seven VRAM II zips through *Windows* like there's no tomorrow—it came in first in every *Excel* test and won two out of three *PowerPoint* tests. At \$370 it also has the second-highest street price, which buys you a very generous seven-year warranty.

The board also offers the second-best selection of drivers and a menu-driven utility to load them. However, the lack of 256-color *AutoCAD* drivers and the lackluster *AutoCAD* performance should discourage users of that application.

Unique among the boards reviewed, the VRAM II requires a special daughtercard when you upgrade from 512K to 1MB. The daughtercard lists for a whopping \$200, and unlike with the Everex Viewpoint VRAM, you can't swap in ordinary RAM to save money.

This is a fast, top-quality board for *Windows*, with the longest warranty we've seen, but the price may deter you.

A Bevy of Smart Buys

Super-VGA technology keeps getting better. The boards in this roundup are

faster, easier to install, and more reliable than last year's models, and most add flicker-free operation for easier viewing. All but one earn a Good overall rating or better.

The bar has been raised, and ATI's VGA Wonder XL and Boca's SuperVGA come away with Best Buys because they soar just a little bit higher. They're the only boards to offer the ease of truly trouble-free switchless installation. ATI piles on the features—including a mouse, menu-driven driver installation, and flicker-free performance for even the best monitors—while Boca slaps on an unbelievably low price and a reassuring five-year warranty.

One final note before you snap up one of these winners: Make the salesperson at your local PC retailer earn his or her pay. Find the board you want, and hook it up to your monitor or to the one you plan to buy. Run it with every application you plan to use, in every super-VGA mode. With the right combination, you'll see lovely, flicker-free images that will stand you in good stead for years to come. ☺

TJ Byers is a contributing editor and Eric Knorr the editor for PC World.

For more information about all products in this article, circle reader service no. 908.

WHERE TO BUY

ATI VGA Wonder XL
ATI Technologies
3761 Victoria Park
Ave.
Scarborough, Ontario
M1W 3S2 Canada
416/756-0718,
416/756-0720 (fax)
Reader service no. 748

Boca SuperVGA
Boca Research, Inc.
6413 Congress Ave.
Boca Raton, FL 33487
407/997-6227,
407/997-0918 (fax)
Reader service no. 749

Everex Viewpoint VRAM
Everex Systems
48431 Milmont Dr.
Fremont, CA 94538
800/992-2839,
415/683-4524 (fax)
Reader service no. 750

Genoa SuperVGA 6400A
Genoa Systems
75 E. Trimble Rd.
San Jose, CA 95131
800/423-6211,
408/434-0997 (fax)
Reader service no. 751

Orchid ProDesigner II
Orchid Technology
45365 North Port
Loop W
Fremont, CA 94538
800/767-2443,
415/490-9312 (fax)
Reader service no. 752

Paradise VGA 1024
Western Digital Corp.
800 E. Middlefield Rd.
Mountain View, CA
94043
415/960-3353
Reader service no. 753

SigmaVGA Legend
Sigma Designs
46501 Landing Pkwy.
Fremont, CA 94538
800/845-8086,
415/770-2640 (fax)
Reader service no. 754

STB PowerGraph Ergo-VGA
STB Systems
1651 N. Glenville
#210
Richardson, TX 75081
800/234-4334,
214/234-1306 (fax)
Reader service no. 755

Trident Impact III
Trident Microsystems
321 Soquel Way
Sunnyvale, CA 94086
800/348-8808,
408/738-3194
California,
408/738-0905 (fax)
Reader service no. 756

Video Seven VRAM II
Headland Technology/
Video Seven Products
46221 Landing Pkwy.
Fremont, CA 94538
800/238-0101,
415/656-0397 (fax)
Reader service no. 757

Everything you crave

1990 World Class Award for Best Mail-Order Company



3 1/2" format available from us. Specify when ordering.

package includes both 5 1/4" and 3 1/2" disks.

3 1/2" format available from manufacturer by request. Call us for details.

CP—copy-protected; NCP—not copy-protected.

The four-digit number next to each product is the product's ITEM NUMBER. Please refer to this number when ordering. Thank you.

SOFTWARE

We only carry the latest versions of products. Version numbers in our ads are current at press time. Products listed here in red are Microsoft Windows Applications.

Adobe Systems ... NCP

- 7547 Adobe Type Manager 1.1 for Windows \$59.
 - 9623 Adobe TypeAlign 1.0 for Windows 69.
 - 9874 Adobe TypeAlign 1.0 for Windows & Adobe Type Manager 1.1 for Windows Bundle . . . 125.
 - 7928 Adobe Plus Pack 1.0. 129.
 - 8367 ATM & Plus Pack Bundle. 189.
 - 7392 Adobe PostScript Cartridge 299.
- (Entire Adobe Type Library, from 1 to 220 is available. Call for more information.)

Aldus ... NCP

- 8000 Persuasion 2.0 for Windows 339.
- 1332 PageMaker 4.0. 499.

Alpha Software ... NCP

- 5104 Alpha Four 1.1 309.

Application Techniques ... NCP

- 1214 Pizazz Plus 2.0 69.
- 9621 Picture Eze 1.0 for Windows. 99.

Ashton-Tate ... NCP

- 4450 dBASE IV 1.1. 499.

Asymetrix ... NCP

- 7384 Toolbook 1.0 for Windows. 299.

Atech Software ... NCP

- 9436 Publisher's Powerpak 1.2 for Windows. 49.
- 9435 Publisher's Powerpak 2.1 for WordPerfect & Microsoft Word 49.

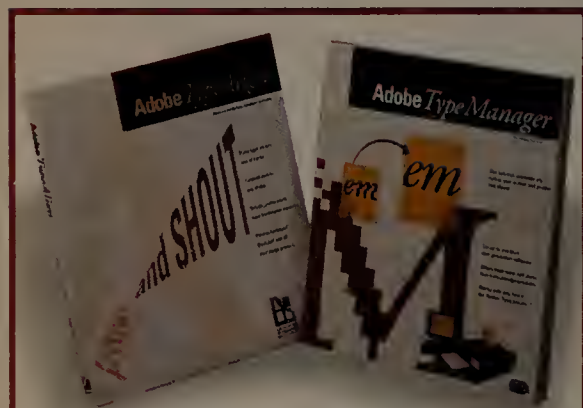

Adobe Systems ... NCP

9874 Adobe TypeAlign 1.0 and ATM 1.1 for Windows Bundle—TypeAlign provides customized text-manipulation with mixed typefaces, styles & sizes. ATM cleans up the jagged or stick figure type. ATM includes 13 scalable fonts . . \$125.

Avery ... NCP

- 6006 Label Pro 1.0 (Laser). \$49.
- 7336 Label Pro 1.0 for Dot Matrix 49.

Berkeley Systems ... NCP

- 9885 After Dark 1.0 for Windows. 29.

Better Software ... NCP

- 9786 Switch-It 3.23 55.

Bitstream ... NCP

- 7568 FaceLift 1.2 for Windows 2.x/3.0. 59.
- 8040 FaceLift 1.5 for WordPerfect 5.0/5.1 59.
- 7569 Companion Value Pack 1.0. 125.
- 8883 Type City Cartridge with Deli. 259.
- Typeface Packages. each 89.

Borland International ... NCP

- 6242 Quattro Pro 3.0. 339.
- 9695 Borland's C++ 2.0. 339.
- 1514 Paradox 3.5 529.
- 7356 Pascal Pro (2nd Edition) 209.
- 9635 Object Vision 1.0 call

Broderbund ... NCP

- 1416 New Print Shop Companion 33.
- 1434 New Print Shop. 39.

Brown-Wagh ... NCP

- 8579 MicroLogic More Fonts 2.0. 75.

ButtonWare ... NCP

- 6419 PC-File 6.0 89.

Caere ... NCP

- 6004 Omnipage 386 3.0 469.
- 8933 Omnipage Professional 1.0 669.



Corel Systems ... NCP

5506 CorelDRAW! 2.0—The PC graphics software that's fast, fun and powerful. CorelDRAW! 2.0 now comes with more drawing power, more type control, and more value...and it's still easy to use \$389.

Central Point ... NCP

- 5039 PC Tools 7.0 115.
- 8114 Backup 7.0 (DOS and Windows) 84.
- 9751 AntiVirus 1.0 84.

Checkfree Corporation ... NCP

- 6360 Checkfree 3.0 19.

Chronologic Corporation ... NCP

- 8849 Instant Recall 1.2 64.

CompuServe

- 7546 DOS Membership Kit 1.3 23.

Concentric Data Systems ... NCP

- 6575 R & R Relational Report Writer 4.0. 159.

Contact Software ... NCP

- 1625 ACT! 2.0 229.

Corel Systems ... NCP

- 5506 CorelDRAW! 2.0 389.

Data Storm ... NCP

- 4798 PROCAMM PLUS 2.0 69.

DCA ... NCP

- 5611 Crosstalk for Windows 1.1. 125.

Delrina Technology ... NCP

- 4325 PerFORM 2.1 95.
- 7351 PerFORMPRO 1.0 (limited time) 159.

Digital Research ... NCP

- 8288 DR DOS 5.0 145.
- 9694 DR DOS Upgrade to 5.0 (from any DOS version) 77.

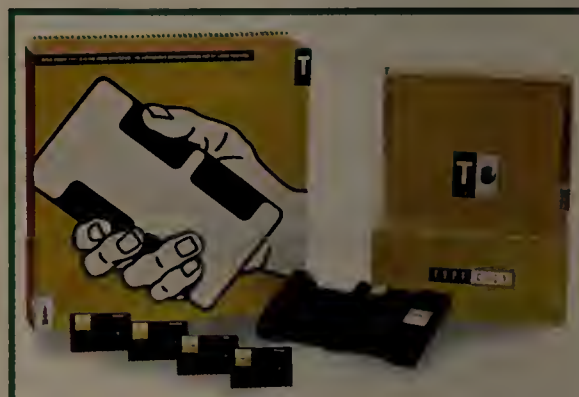

Bitstream ... NCP

8883 *Type City*—New high-speed type cartridge system for HP LaserJet II, IIP & III - entirely new text & headline faces with Windows screen fonts. Expands with add-on cards. Innocent's Guide to Type & \$99 Deli card included free . \$259.

DMA ... NCP

- 8378 PC Anywhere IV 4.03 105.

Dow Jones ... NCP

- 6706 Market Manager PLUS 3.0 199.

Fifth Generation Systems ... NCP

- 7725 Direct Access 5.1 65.
- 3950 Fastback Plus 3.0 119.

FormWorx ... NCP

- 5810 FormWorx with Fill & File 2.5. 85.
- 9332 Form Publisher for Windows w/Fill & File 109

Fox Software ... NCP

- 6188 FoxPro 2.0 (exp. release 6/28/91) 459.

Funk Software ... NCP

- 7380 P.D. Queue 1.0 (print spooler). 59.
- 2228 Sideways 3.3 59.

Geoworks ... NCP

- 8789 Ensemble 1.0 129.

Gibson Research ... NCP

- 9832 SpinRite II 2.0 64.

Great American Software ... NCP

- 9827 Business Value Pack (Money Matters 2.0 & Payroll 2.0) 99.

- 4880 One Write Plus Acct. Sys. 2.06 189.

Hayes ... NCP

- 7983 Smartcom Exec 2.0 79.
- 9639 LANstep 1.0 349.

hDC Computer Corporation ... NCP

- 8974 Icon Designer 1.0 35.
- 7389 Windows Express 3.0 52.
- 7383 First Apps 1.0 52.



Dow Jones ... NCP

6706 Market Manager PLUS 3.0—Spend more time buying and selling! Let it update your securities, alert you to news, generate reports, and handle recordkeeping details such as stock splits, dividend tracking and interest payments \$199.

to crunch or create,



Inset Systems ... NCP

7298 **Hijaak 2.0**—Capture screens & convert graphics files with Hijaak release 2.0. New features include 5K pop-up window, many new raster & vector formats and support for more than 16 Group 3 fax devices. \$99.

Helix Software ... NCP

- 9627 Netroom 1.1 (single user) 52.
- 9628 Headroom 2.0 65.

Hilgraeve ... NCP

- 8204 HyperACCESS/5 2.0 (DOS) 65.

Individual Software ... NCP

- 6222 Resume Maker 1.3 29.

Inner Media, Inc. ... NCP

- 8846 Wide Angle 1.0 for Windows 69.

Inset Systems ... NCP

- 7298 HiJaak 2.0 99.
- 7300 Inset Plus HiJaak 125.

Insight Development ... NCP

- 8320 PrinTools 1.0 85.

Insight Resource ... NCP

- 8851 KO-Pilot for WordPerfect 5.1 55.

Intuit ... NCP

- 2426 Quicken 4.0 39.
- 1856 QuickPay 1.0 35.

Isogon ... NCP

- 7478 FontSpace 2.0 59.

LaserTools ... NCP

- 6882 PrintCache 2.3 99.

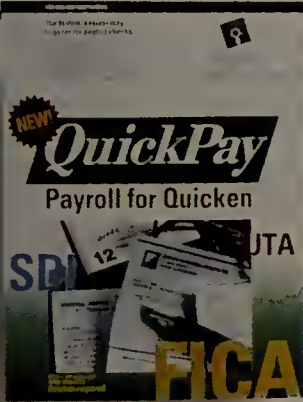

Intuit ... NCP

1856 **QuickPay 1.0**—Works with Quicken. Select an employee & QuickPay calculates federal, state & local taxes. It completely fills out Quicken checks showing all period & year-to-date wages & deductions \$35.

Lord Publishing ... NCP

- 5191 Ronstadt's Financials 1.02 \$75.

Lotus ... NCP

- 5417 1-2-3 3.1 Plus 429.
- 5653 1-2-3 2.3 349.
- 1852 1-2-3 2.3 Upgrade 95.
- 1841 1-2-3 Upgr. from any ver. to 3.1 Plus 119.
- 5799 Ami Pro 1.2 309.
- 1621 Freelance Graphics for DOS 4.0 329.

MECA ... NCP

- 2798 Managing Your Money 7.0 99.

Micro Logic ... NCP

- 6787 Info Select 2.0 95.

Microcom ... NCP

- 7649 Virex-PC 2.0 79.
- 6234 CarbonCopy Plus 6.0 119.

Microlytics ... NCP

- 9636 Strunk & White Elements of Style 1.0 35.
- 7931 Random House Encyclopedia 1.0 68.

Microsoft ... NCP

- 2894 QuickBasic 4.5 69.
- 7010 Windows 3.0 99.
- 7388 Project 1.0 for Windows 459.
- 7882 Productivity Pack 1.0 for Windows 45.

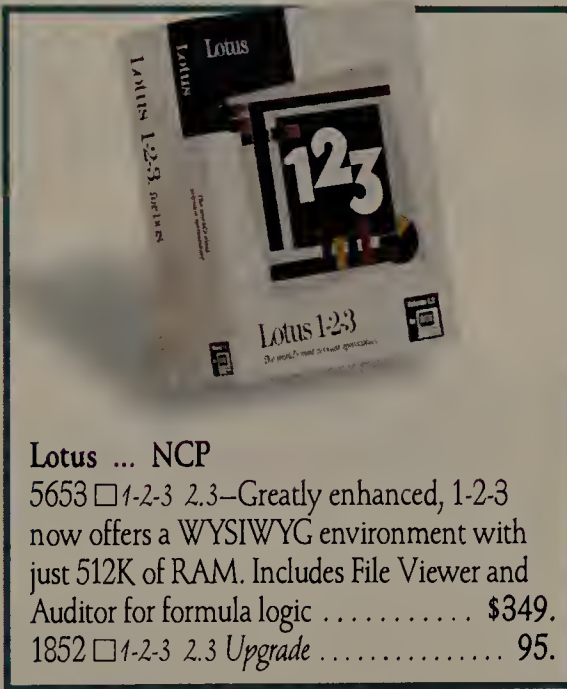

Lotus ... NCP

5653 1-2-3 2.3—Greatly enhanced, 1-2-3 now offers a WYSIWYG environment with just 512K of RAM. Includes File Viewer and Auditor for formula logic \$349.
1852 1-2-3 2.3 Upgrade 95.

- 2904 Works 2.0 99.
 - 2901 Word 5.5 209.
 - 7387 PowerPoint 2.0 for Windows 329.
 - 6195 Word 1.1 for Windows 329.
 - 2856 Excel 3.0 for Windows 329.
 - 8137 Office for Windows (includes Excel, Word for Windows, and PowerPoint) 499.
 - 2853 C Compiler 6.0 329.
 - 1620 DOS 5.0 Upgrade 65.
 - 1624 Visual Basic 1.0 139.
- ### Multisoft ... NCP
- 4925 PC-Kwik Power Pak 2.0 75.
- ### Nantucket ... NCP
- 2970 Clipper 5.0 529.
- ### NBI, Inc. ... NCP
- 9618 Legacy 1.1 289.

1-800/243-8088



PC Connection
6 Mill Street
Marlow, NH 03456

870W

SALES 603/446-7721 FAX 603/446-7791

Microsoft MS-DOS 5 Upgrade

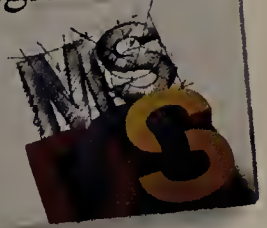

Microsoft ... NCP

1620 **DOS 5.0 Upgrade**—Improved graphical shell, on-line help, task swapping, full screen editor, and more are all awaiting you with DOS 5.0. Upgrade your current DOS with ease to DOS 5.0 for only \$65.

Nolo Press ... NCP

- 5122 For The Record 2.0 35.
- 2982 WillMaker 4.0 39.

OCR Systems ... NCP

- 9879 ReadRight 2.01 309.
- 9878 ReadRight 3.0 for Windows 309.

Okna ... NCP

- 9696 Desktop Set 3.0 for Windows 85.

Passport Design ... NCP

- 1329 Encore 2.0 379.

PC Globe ... NCP

- 5902 PC Globe 4.0 39.
- 5900 PC USA 2.0 39.

Personics ... NCP

- 9288 Laptop Ultravision 2.1 (3 1/2" only) 49.
- 4384 Ultravision 2.0 79.
- 7048 Monarch 1.0 319.

PowerUp ... NCP

- 7860 Calendar Creator Plus 4.0 45.
- 7861 Address Book Plus 3.0 49.
- 7857 Labels Unlimited 3.0 49.
- 7858 Express Publisher 2.0 89.

Precision Software ... NCP

- 6600 Superbase 4 for Windows 1.2 429.

Qualitas ... NCP

- 7539 386MAX 5.1 75.
- 7967 BlueMAX 5.1 for PS/2 (3 1/2" only) 85.

Quarterdeck ... NCP

- 6422 QRAM 1.0 54.
- 3221 Expanded Memory Mgr. 386 5.1 65.
- 3220 DESQView 2.3 85.
- 4586 DESQView 386 2.3 145.

QUE Software ... NCP

- 4155 RightWriter 4.0 54.
- 1857 RightWriter 4.0 Network 169.

Reality Technologies ... NCP

- 7891 WealthStarter 1.0 39.
- 6572 WealthBuilder 1.1 99.

Reference Software ... NCP

- 4396 Grammatik IV 2.0 59.
- 7483 Grammatik for Windows 2.0 59.

Revolution Software ... NCP

- 4480 VGA Dimmer 3.0 (screen saver) 29.

Roynore ... NCP

- 8162 ABC Flowcharter 1.1 189.

Sitka ... NCP

- 6675 TOPS Network Bundle 3.0 159.
- 3720 Flashcard 2.1 (AppleTalk network card) 155.
- 7330 Flashcard MicroChannel 219.

To turn checks,



Que Software ... NCP
4155 **RightWriter 4.0**—Make your writing clearer and more powerful. RightWriter proofreads documents for errors in grammar, style, word usage, and punctuation. Works with all major word processors. \$54.

- Softlogic Solutions ... NCP**
3542 Software Carousel 5.0 55.
- Software Publishing ... NCP**
3496 Professional Write 2.2 169.
9638 Professional Write Plus 1.0 175.
3482 Harvard Graphics 3.0 (limited time) . . . 359.
- Solution Systems ... NCP**
7977 Brief 3.1 (Programmer's Editor) 189.
- Spinnaker ... NCP**
1415 PFS: WindowWorks 1.0 129.
7604 PLUS for Windows 2.0 289.
- Stac Electronics ... NCP**
1409 Stacker 1.1 89.
- Symantec ... NCP**
6397 The Norton Backup 1.2 105.
3146 The Norton Utilities 6.0 119.
3425 Q&A 4.0 239.
7999 Norton Anti-Virus 1.0 89.
- Systems Compatibility ... NCP**
9046 Complete Writer's Toolkit 1.0 85.
8215 Outside In 2.0 85.
6564 Software Bridge 5.0 79.
- Teleware ... NCP**
9847 M.Y.O.B. for Windows 139.
- TIMESLIPS ... NCP**
2987 Timeslips III 4.0 195.
6994 PercentEdge 1.0 69.
1270 TimeSheet Pro 2.0 145.
- Timeworks ... NCP**
6253 Publish-It! 2.0 139.



Quarterdeck ... NCP
3221 **Expanded Memory Manager 386 5.1**—Finds up to 200K of "hidden" memory in your PC and manages Expanded or Extended memory. A must-have for memory-hungry software, networks or Windows 3.0 . . . \$65.

- T/Maker ... NCP**
1051 Color Graphics Presentation 1.0 \$95.
 ClickArt (EPS and Bitmap available) . . . call
- Touchstone Software ... NCP**
7420 Check It 3.0 89.
- Traveling Software ... NCP**
5179 LapLink III 3.0 95.
- West Lake Data Corporation ... NCP**
7577 PC-FullBak+ 2.0 52.
- WordPerfect Corporation ... NCP**
7781 LetterPerfect 1.0 129.
3804 WordPerfect 5.1 265.
6685 DrawPerfect 1.1 279.
- WordStar International ... NCP**
1482 Correct Grammar 1.0 for Windows 65.
6791 WordStar Professional 6.0 199.
- XTREE ... NCP**
6161 XTree Gold 2.0 95.
- Z-Soft ... NCP**
1626 Publisher's Paintbrush for Windows . . . 299.

RECREATIONAL/EDUCATIONAL

- Broderbund ... CP**
8068 Where in the World is Carmen
San Diego Deluxe Edition 52.
5851 SimCity 33.
8886 SimEarth 45.



TIMESLIPS ... NCP
6994 **PercentEdge 1.0**—Calculates mortgage rates, present values, annuities, savings & loan balances, and more. "Fill in the blank" interface complete the calculation once your data is entered. "Pop-up" mode available . . . \$69.

- Electronic Arts ... NCP**
4534 Mavis Beacon Teaches Typing 1.0 (CP) 35.
7865 PGA Golf 35.
- Harvard Associates ... NCP**
2324 PC Logo 3.0 59.
- HyperGlot Software ... NCP**
(French, German, Italian, Spanish available.)
 Word Torture for Windows ea. 34.
 Word Torture 3.0 ea. 29.
- Microsoft ... NCP**
7881 Entertainment Pack for Windows 1.0 . . 29.
2858 Flight Simulator 4.0 39.
8270 Aircraft and Scenery Designer 1.0 29.
- Microsoft Press (Books)**
8129 Running Windows (2nd Edition) 22.
8136 Running Microsoft Excel 22.
- Penton Overseas ... NCP**
 VocabuLearn/ce Levels I & II (French, Italian, German, Spanish, Russian, Hebrew and Japanese) each 35.
- Sierra ... CP**
9466 Space Quest IV (VGA) 39.
7972 King's Quest V (VGA) 45.
- SirTech ... CP**
8235 Bane of the Cosmic Forge 39.
- Software Toolworks ... NCP**
4659 Chessmaster 2100 (CP) 35.
7372 World Atlas 42.



Microcom ... NCP
7649 **Virex-PC 2.0**—Powerful, comprehensive solution to DOS-based computer viruses. Featuring: MiniScan TSR for continuous virus protection, Windows & Network compatible, less than 1K & detects over 450 viruses . \$79.

- Spectrum Holobyte ... NCP**
3467 Tetris 22.
- Stone & Associates ... NCP**
5231 Phonics Plus 1.1 22.
3439 2nd Math 4.2 27.
- Toyogo ... NCP**
7674 Nemesis Go Master 4.7 41.
7676 Nemesis Go Master Deluxe 4.7 88.
- True BASIC, Inc. ... NCP**
 Kemeny/Kurtz Math Series each 45.

HARDWARE

Warranties listed next to manufacturer.

- Acme/SAFE Power Systems ... 2 years**
6747 Safe 400S 399.
- American Power ... 2 years**
7108 Smart UPS 400 339.
7105 Smart UPS 600 469.
6811 Back-UPS 360 219.
7106 Back-UPS 520 329.
- AST Research ... 5 years**
1299 SixPakPlus 384k C/S/P 179.
8041 SixPak 286 0k 99.
- ATI Technologies ... 2 years**
9821 VGA Basic-16 (640 x 480, 16 colors) 85.
9985 VGA Integra (1024 x 768, 64 colors) 129.
9629 VGA Wonder XL (256K upgradable to 1MB) 199.
9619 Ultra/8514 Graphics Card (512K) (req. VGA) 419.
1825 2400etc/i Modem (w/9600 SendFax) 139.
9620 9600etc/e Modem 379.
- Avery ... 90 days**
1601 1st Impression First Pack 57.
1600 Avery 1st Impression 229.
- Boca Research ... 5 years**
7001 BOCARAM/AT PLUS (0-8 Meg) 119.
7061 BOCARAM/XT 0K (0-2 Meg, LIM 4.0) 99.
6998 I/O Board for AT 59.
6999 I/O Board for Microchannel (S/S/P) 109.
8380 BasicVGA (256K, 640 x 480) 69.
8381 SuperVGA (1 Meg, 1024 x 768) 145.
- Bravo Communications ... 2 years**
7400 2 Position Laser Compatible Switch Box . 109.
- Brown-Wagh ... 1 year**
8578 Creative Labs Sound Blaster 159.
- Canon ... 1 year**
7894 BJ-10e Printer with free case (4.6 lb.) . . . 329.
7897 BubbleJet Ink Cartridge (BJ-10e) 23.
9037 BJ-300 Printer (80 column) 549.
9038 BJ-330 Printer (136 column) 649.
7896 BJ-10e Sheet Feeder 75.
9828 BubbleJet Ink Cartridge (BJ-300 & BJ-330) 26.
- CH Products ... 1 year**
7801 FlightStick w/Falcon 49.
7345 RollerMouse (Trackball) serial . 85. bus . 99.



PC Commitment.

**Don't stand on ceremony.
(Or, why you should give us a ring.)**

Here in the conjugal kingdom of Marlow, NH (pop. 566) we take our vows pretty seriously. In fact, this summer alone, a lucky 7 of our employees are getting hitched. Sure, we know some people think of country weddings as last-minute affairs that only take place thanks to the persuasive power of the proverbial shotgun. But actually, we believe in taking it slow and doing things right the first time. Whether it's baiting the hook or tying the knot.

And regardless of the local mating habits, rest assured that when you buy from us, we'll still love you tomorrow (by which time there's a

good chance your order will have arrived). Because when you're a PC Connection customer the honeymoon never ends, the bloom is never off the rose, and, most important of all, the tech support is always free. You'd be hard pressed to find a more perfect union.

Marriage is for the birds. (And bees.)

Know what happens to the rice that's thrown after a wedding? Little birdies often eat it and their tiny tummies start to ache. And that's no tweet. To remedy this fowl situation we're sending a wedding-season's supply of premium PC Connection birdseed (with a convenient reusable carrying pouch) to everyone who places an order of \$500 or more between now and September 30.



Don't get left at the altar without a supply of PC Connection birdseed. One per customer. Not available outside continental U.S.

PC CONNECTION®

chits or charts out



WordStar International ... NCP
 6791 *WordStar Professional 6.0*—Version 6.0 incorporates pull down menus, page preview and more. \$199.
 1482 *Correct Grammar 1.0 for Windows*—Works with any Windows application. . . 65.

- CoStar ... lifetime**
 6091 The Organizer (mobile storage cart) 199.
 1418 AddressWriter Envelope Printer 469.
 1812 LabelWriter II Printer 195.
- Curtis ... lifetime**
 9756 Keyboard Space Saver II KS-2 39.
 1708 Ruby-Plus SPF-2+ 65.
 7358 Command Center SPF-4 89.
 Glass Filter Plus (specify size) each 65.
- Cyrix Corporation ... 5 years**
MATH COPROCESSORS
 9875 FasMath 83D87-25 359.
 9876 FasMath 83D87-33 439.
 9877 FasMath 83S87-16 (SX compatible) 219.
- Datadesk ... 3 years**
 6901 Switchboard. 159.
- Epson ... 2 years**
 We are an authorized Epson Service Center.
 1906 FX-850 (80 col., 264 cps, 9 pin) call
 1904 FX-1050 (136 col., 264 cps, 9 pin) call
 5183 LQ-510 (80 col., 180 cps, 24 pin) call
 1930 LQ-850 (80 col., 264 cps, 24 pin) call
 1917 LQ-1050 (136 col., 264 cps, 24 pin) call
 5184 LX-810 (80 col., 180 cps, 9 pin) 185.
- Everex ... 1 year**
 1683 Tempo LX Notebook (5 Meg, 60 Meg HD) 3499.
- Hauppauge Computer ... 1 year**
 9031 20 MHz 386 Motherboard for PC 995.
 9032 20 MHz 386 Motherboard for XT 995.
 9870 25 MHz 386 Motherboard for AT 1099.
 9034 33 MHz 386 Motherboard for AT 1339.
- Hayes ... 2 years**
 2307 Smartmodem 2400 349.
 7391 Ultra 9600 Modem (\$150 rebate till 8/18) 669.
 9884 Pocket Edition 2400 Plus 129.
- Hewlett-Packard ... 1 year**
 9993 LaserJet IIIP (with toner) 1149.
 6754 LaserJet III (with toner) 1699.
- Hitachi ... 2 years**
 9492 CM1483M 14" SVGA Monitor (1024 x 768) 599.
 9491 CM2085M 20" SVGA Monitor (1280 x 1024) 1995.
- Intel ... 5 years**
 6421 2400B MNP Internal Modem 199.
 5119 2400 Baud External Modem 179.
 6420 2400EX MNP Modem 229.
 7880 9600EX Modem. 549.
 2346 Inboard 385/PC with 1 Meg 495.
 5336 Above Board Plus 8 2 Meg 449.
 5342 Above Board Plus 8 I/O 2 Meg 479.

- 7782 SatisFAXtion (fax board) \$399.
 8778 SatisFAXtion for Microchannel 449.
 8901 Matched Memory 2 Meg (PS/2) 139.
 8903 Matched Memory 4 Meg (PS/2) 299.
 Matched Memory (for LaserJet IIP, III, IIIP IIID)
 1810 1 Meg 99. 1787 2 Meg 299.
- MATH COPROCESSORS**
 7385 80287XL (16 MHz 80286 CPU's) 199.
 4750 80387SX (16 MHz 80386SX CPU's) 309.
 2372 80387-20 (20 MHz 80386 CPU's) 399.
 4121 80387-25 (25 MHz 80386 CPU's) 499.
- Kensington Microware ... 1 year**
 2582 Master Piece Plus. 99.
 7899 Expert Mouse serial . 119. 7900 bus . 129.
- Keytronic ... 3 years**
 4518 101 Plus Keyboard 99.
- Kraft ... 5 years**
 5800 3 button Thunder Joystick 29.
 7862 TopTrak (Laptop Trackball) 75.
- Logitech ... limited lifetime**
 6029 Trackman serial. . . . 85. 6028 bus. . . . 89.
 1484 ScanMan 32. 169.
 7975 ScanMan 256. 319.
 8694 MouseMan (serial) 69. 9766 (cordless) 139.
- Megahertz ... 5 years**
 1193 T324D 2400 Modem (for Toshiba Laptops) 129.
 1196 T224 2400 Modem (for Toshiba Laptops) 129.
 1187 T324FM 96/24 Fax Modem (Toshiba Lptps.) 299.

Intel Matched Memory
 provides 100% compatible memory for:
 • LaserJet IIP
 • LaserJet III, IIID, IIIP

Intel ... 5 years
Matched Memory—Increase your LaserJet IIP, III, IIID, or IIIP memory. Easy installation & better performance make these an obvious choice.
 1810 Matched Memory (1 Meg Module) . . . \$99.
 1787 Matched Memory (2 Meg Module) . . . 159.

- Micron Technology ... 2 years**
 7595 2 Meg Expansion for HP LaserJet IIP or III 119.
 7012 Memory Upgrade PS/2 70 - 2 Meg. . . . 139.
- Microsoft ... lifetime**
 7597 Microsoft Mouse 89.
 2897 Mouse with Paintbrush 105.
 2898 Mouse with Windows 3.0 149.
- MicroSpeed ... 1 year**
 PC-TRAC Trackball
 6007 serial 75. 6008 bus 89.
 7271 Inport 79. 6330 PS/2 79.

1-800/243-8088

MMC PC Connection 870W
 6 Mill Street
 Marlow, NH 03456
SALES 603/446-7721 FAX 603/446-7791

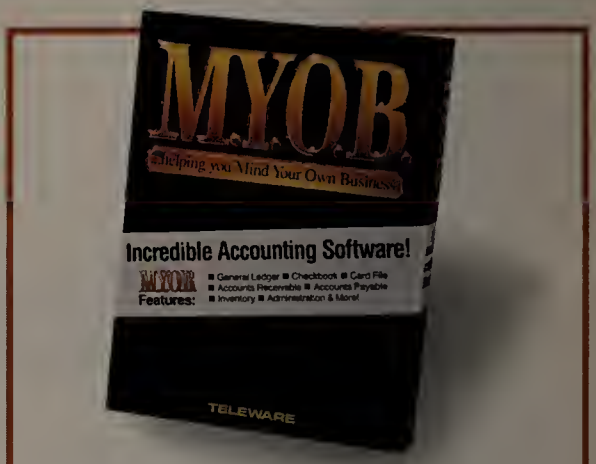

Teleware ... NCP
 9847 *M.Y.O.B. for Windows*—Incredible Accounting Software for Windows. M.Y.O.B. contains full-featured G/L, A/R, A/P, Inventory and Card file. The hottest selling program for the Mac is now available for PC users . \$139.

- Mouse Systems ... lifetime**
 5997 Trackball (1 yr. wrnty.) serial. . 65. bus. . 69.
 7878 PC Mouse III (serial) 89. (bus) 95.
- NEC ... 2 years**
 9441 CDR36 Portable CD-ROM Drive 399.
 4799 Multisync 2A (VGA Monitor) 499.
 5085 Multisync 3D Monitor 689.
- Orchid Technologies ... 4 years**
 7863 ProDesigner VGA IIS (with 1 Meg and standard RAMDAC) 359.
- PC Power & Cooling ... 1 year**
REPLACEMENT POWER SUPPLIES
 3203 Turbo Cool 200. 149.
 7915 Turbo Cool 300. 165.
 3200 Silencer 150 (84% noise reduction) 115.
 7053 InnerSource 2210 (power backup) 349.
- Pacific Data Products ... lifetime**
 6779 25 Cartridges in One! (for LJ II, IIP, III) . . 275.
 8975 Complete Font Library (for LJIII) 275.
 Memory upgrade for LaserJet IIP/III:
 7055 2 Meg 149. 7759 4 Meg 259.
 Memory upgrade for LaserJet II/IIID:
 6838 2 Meg 249. 6836 4 Meg 379.

Hayes ... 2 years
 7391 Ultra 96 Modem—Get ultra high modem performance & error control without sacrificing compatibility. Purchase before 8/18/91 and receive \$150 rebate direct from Hayes. . \$669.

at a super fast rate.

7158	Pacific Page PE 4.0 (for LJ IIP/III)	\$379.
6834	Pacific Page (for LJ II) w/2 Meg Mem. Brd.	379.
9833	Pacific Page XL (w/accelerator board)	799.
Practical Peripherals ... 5 years		
3103	2400 Baud Internal Modem	129.
3102	2400 Baud External Modem	179.
8993	2400 Baud Internal Modem (V.42 bis)	169.
8994	2400 Baud External Modem (V.42 bis)	209.
4542	2400 Baud Internal Modem for PS/2	229.
8132	PM2400 Pocket Modem	109.
7934	PM9600SA Modem	489.
Targus ... lifetime		
4900	Lappac 2 Carrying Case (Horizontal)	55.
6037	Premier Leather Carrying Case	179.
TheComplete PC ... 2 years		
8082	TheComplete Half Page Scanner/400	289.
5828	TheComplete Communicator	449.
Toshiba ... 1 year		
9893	T2000SX Notebook (40 Meg)	2999.
9894	T1200XE Laptop (40 Meg)	2099.
Tripp Lite ... 2 years		
6199	Isobar 4-6 (4 outlets, 6 ft. cord)	49.
6200	Isobar 6-6 (6 outlets, 6 ft. cord)	59.
6201	Isobar 8-12 (8 outlets, 12 ft. cord)	69.
6018	LC1200 (1200W line conditioner)	159.
1528	PS6.0 (600VA on-line UPS)	559.
Video 7 ... 7 years		
4931	VRAM II VGA 512k	349.
Zoom Telephonics ... 7 years		
1307	2400 Baud w/9600 Baud Fax Modem	129.
1181	2400 Baud V.42bis Modem	159.

Seagate ... 1 year		
4554	40 Meg Internal HD ST251-1 (28 ms)	\$269.
1321	ST157A 40 Mb IDE Hard Drive	239.
1320	ST1144A 130 Mb IDE Hard Drive	499.
TEAC ... 1 year		
4670	1.44 Meg Drive for PC/XT (3 1/2")	75.
4326	1.44 Meg Drive for AT (3 1/2") with Bastech software	99.
4951	720k Drive for PC/XT (3 1/2")	69.
6951	1.2 Meg Drive for AT (5 1/4")	79.

MEMORY

6556	256k DRAM (100 ns, set of 9)	call
5510	1 Meg x 9 SIMMs (80 nanosecond)	call
5746	1 Meg Chips (80 ns, set of 9)	call
7813	256k x 4 Chips	call

OUR POLICY

- We accept VISA and MASTERCARD only.
- No surcharge added for credit card orders.
- Your card is not charged until we ship.
- If we must ship a partial order, we never charge freight on the shipment(s) that complete the order (in the U.S.).
- No sales tax, except Ohio residents (please add applicable tax).
- All U.S. shipments insured; no additional charge.
- APO/FPO orders shipped 1st Class Mail.
- International orders U.S. \$250 minimum. Manufacturer support and upgrade eligibility may be limited outside the U.S.A.
- Upon receipt and approval, personal and company checks clear the same day for immediate shipment of your order.
- COD max. \$1000. Cash, cashier's check, or money order.
- 120 day limited warranty on all products. Defective software replaced immediately. Defective hardware repaired or replaced at our discretion. All items subject to availability. Prices and promotions subject to change without notice.
- To order, call us Monday through Friday 8:00 a.m. to 1:00 a.m., or Saturday 9:00 a.m. to 5:30 p.m. Eastern Time. You can call our business offices at 603/446-3383 Monday through Friday 9:00 a.m. to 5:30 p.m.

DISKS/MEDIA

Maxell ... lifetime		
2789	5 1/4" MD2-D 360k Disks (Qty. 10)	10.
2790	5 1/4" MD2-D 1.2 Mb Diskettes (Qty. 10)	15.
2792	3 1/2" DS/DD 720k Diskettes (Qty. 10)	13.
2793	3 1/2" DS/HD 1.44Mb Diskettes (Qty. 10)	21.



Canon ... 1 year
7994 BJ-10e BubbleJet Printer—Light weight, excellent print quality and a great price make this 4.6 lb. printer a winner. Choice of black or white. Optional sheet feeder \$329.



Everex ... 1 year
1683 Tempo LX Notebook Computer—16 MHz 80386SX with 5 Meg of RAM. 7.1 lbs. including Nicad battery. 1.44 Meg Floppy & 60 MB IDE HD. Incl. MS DOS 4.01, mouse & Windows 3.0. Great machine \$3499.

DRIVES

CD Technology ... 1 year		
8057	Porta-Drive CD-ROM	649.
8105	Installation Kit for Standard Bus	155.
Conner Peripherals ... 1 year		
8875	CP3044 40 Meg IDE HD (25 ms)	299.
8876	CP3104 100 Meg IDE HD (25 ms)	499.
1337	CP3204 200 Meg IDE HD (16 ms)	899.
IOMEGA ... 1 year		
5116	Bernoulli II 44 Meg Internal	829.
7551	Bernoulli II Transportable 44 Meg	929.
5113	44 Meg Cartridge Tripak (5 1/4")	269.
2500	PC2B Controller	209.
Mountain Computer ... 2 years		
2137	40-60 Meg Internal Tape Drive	259.
5110	DC2000 Pre-formatted Cartridges . . . ea.	35.
6133	DC2120 Tape Cartridge (5 pack)	149.
Pacific Rim ... 1 year		
1124	1.2 Meg External (for any parallel port)	265.
6132	1.44 Meg External (for PC/XT/AT)	239.
Plus Development ... 2 years		
8134	Hardcard II XL 50 Meg (9 ms)	399.
8137	Hardcard II XL 105 Meg (9 ms)	599.



Practical Peripherals ... 5 years
7934 PM9600SA Modem—Practical Peripherals does it again by making communications affordable with their newest modem featuring the data compression & error correction of 9600bps V.32 & V.42bis operation \$489.

Sony ... lifetime		
3291	5 1/4" DS/DD 360k Disks (Qty. 10)	8.
3297	3 1/2" DS/DD 720k Diskettes (Qty. 10)	11.
3298	3 1/2" DS/HD 1.44Mb Diskettes (Qty. 10)	18.
6148	3 1/2" DS/DD (3 Pack)	29.
6375	3 1/2" DS/HD (3 Pack)	49.
8185	QD 2040 Tape Cartridge	19.
3M ... lifetime		
3943	DC 2000 Tape Cartridge	19.
6065	DC 2080 Tape Cartridge	25.
3944	DC 600 Tape Cartridge	29.
5679	DC 6150 Tape Cartridge	29.

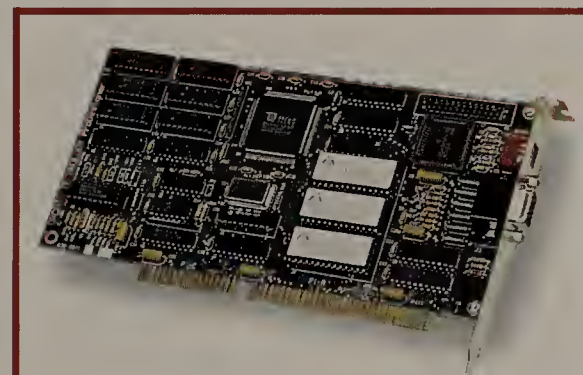

Orchid Technologies ... 4 years
7863 ProDesigner VGA IIS with 1 Meg—Flicker-free graphics in all 17 standard VGA modes—up to 1024 x 768 with 256 colors. It's socketed for either the Edsun CEG RAMDAC or the Sierra RAMDAC for extra colors \$359.

SHIPPING

- Note:** Accounts on net terms pay actual shipping.
- Continental US:**
- For heavy hardware items such as printers, monitors, Bernoulli Boxes, etc. pay actual charges. Call for UPS 2nd-Day & Next-Day-Air.
 - For all other items, add \$3 per order to cover UPS Shipping. For such items, we automatically use Airborne Express at no extra charge if you are more than 2 days from us by UPS ground.
- Hawaii:**
- For monitors, printers, Bernoulli Boxes, computers, hard drives, and power backups, actual UPS Blue charge will be added. For all other items, add \$3 per order.
- Alaska and outside Continental US:**
- Call 603/446-7721 for information.

There's more to comparing LaserJet memory boards than just the name.

	Pacific Data Products	Hewlett-Packard
Price	<p>1 MB / \$149</p> <p>2 MB / \$219</p> <p>4 MB / \$399</p>	<p>1 MB / \$230</p> <p>2 MB / \$390</p> <p>4 MB / Not Available</p>
Warranty	Lifetime	One Year
Upgradeability	Fully Upgradeable to 4 MB	Not Upgradeable

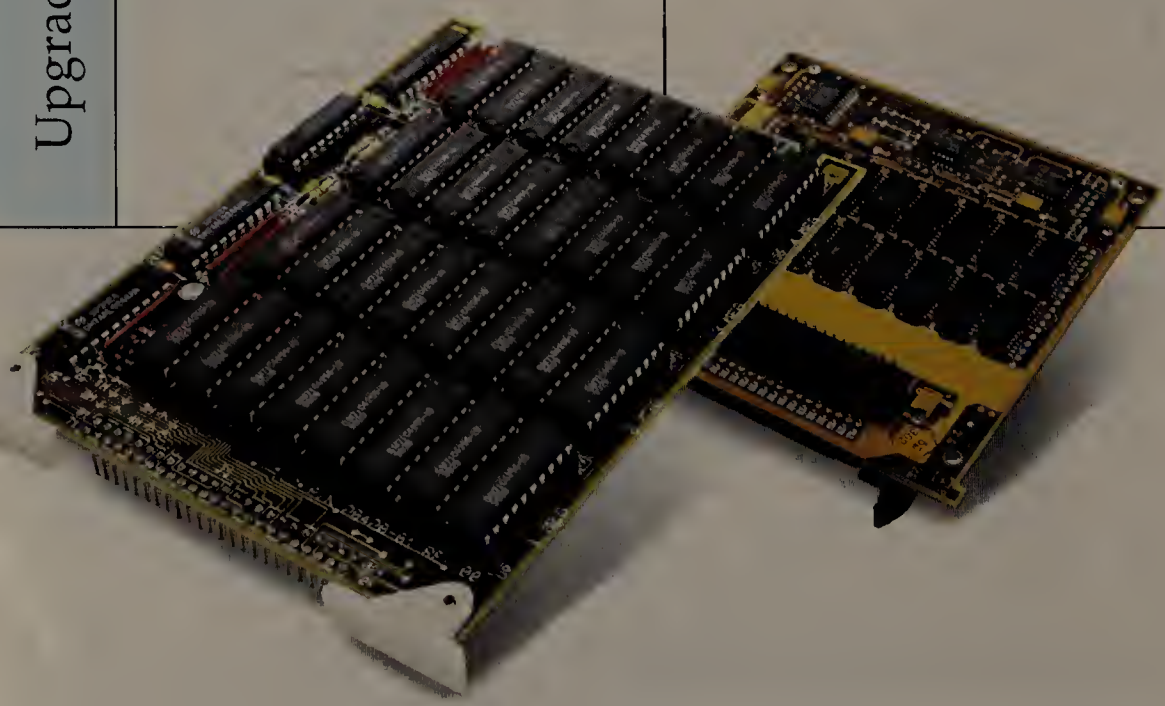

Don't settle for less just to buy the HP label. Get more for less with Pacific Data Products **Pacific 4 Memory™** for HP LaserJet IIP, III, IIID, and IIIP printers. With **Pacific 4 Memory** you get 4 MB of memory for not much more than the price of 2 MB from HP. And each board is upgradeable, so you can start with 1 MB of memory then simply install additional memory chips when you need more.

We want you to have the same confidence that we do in our products, so we back each memory board with a lifetime warranty and a full money back guarantee of satisfaction.

To learn how you can get more for less, call your nearest dealer or contact:

Pacific Data Products,
9125 Rehco Rd., San Diego,
CA 92121, (619) 597-4614
Fax (619) 552-0889.



PACIFIC
DATA PRODUCTS

Prices are suggested retail list price effective 1/15/90. Pacific 4 Memory is a trademark of Pacific Data Products, Inc. HP and LaserJet are registered trademarks of Hewlett-Packard Corporation. All other company and product names are trademarks of the company or manufacturer respectively. © 1991 Pacific Data Products, Inc. EUROPEAN HEADQUARTERS: Switzerland
Tel: (41) 22-412650, Fax: (41) 22-410682.

All-in-One Business Software

If you're an occasional user or a laptop jockey, one of these low-cost integrated packages can handle all your word processing, spreadsheet, data management, and communications needs.

George Campbell



What's the first thing you do after acquiring a computer? You buy a collection of applications to go with it, of course. Combined, they can be almost as expensive as the computer itself. And learning how to use one program will in no way help you learn the others: They all behave differently.

And what if that new computer is a laptop with a small hard disk—or no hard disk at all? If you try taking all those programs on the road, you may find yourself shuffling floppies like a talentless magician trying a half-remembered card trick.

If you seem to need more software than you can afford, store, or learn, you've got another option. A single, inexpensive, integrated package can provide word processing, data management, a spreadsheet, modem communications, and desktop utilities, all for less than \$200. And integrated programs are truly cheap dates, working just fine on floppy-based, XT-class machines with a minimum of disk space. If you don't need the heavy power of stand-alone programs and you're looking for an easy way to coordinate all your computing jobs, one of these packages may be the answer.



Framework XE's multiple layers of menus can easily produce a confusing collection of boxes.

At their best, the various modules in an integrated package work together much better than separate programs do, even *Windows* applications. The better integrated programs use the same menus as you go from one module to another, making them easy both to learn and to use. They also let you exchange data easily—five of the six programs reviewed here, for instance, let you merge data directly from your data base to your word processor. Such magic is still a dream in *Windows*.

What's In, What's Out

You'll find all the essentials in these packages, but not the complicated extras. Consider the module most people use more than any other, the word processor. You can check spelling and do some basic editing, but don't expect to create the fancy reports and newsletters you can in *WordPerfect*. The other modules tend to be similar: You can crunch numbers, maintain data base records, or get on line, but don't look for back-solving spreadsheet analysis or complex data base file linking.

If these limitations seem too confining but you still want a tightly integrated package, you have another op-

tion—a more powerful, more expensive integrated program such as *Lotus Symphony* or *Framework*. But if you need the additional power, you'll probably be happier with one of the stand-alone programs that are designed to do one thing and generally do it very well.

We looked at six inexpensive integrated packages and found one Best Buy—*Microsoft Works*. It's outstandingly easy to use, offers excellent integration between modules, and its all-important word processor stands clearly above the rest.

Eight-in-One 2.03

PROS: Low cost, good word processor, excellent desktop utilities

CONS: Little data exchange between modules, limited spreadsheet and data base tools, no macros

Spinnaker's *Eight-in-One* isn't as powerful as most of its rivals, but its amazingly low \$59.95 price makes it a good buy if you need a capable little word processor backed up with a well-designed calendar, calculator, and other desktop tools.

Eight-in-One's desktop accessories

could succeed as a stand-alone utility collection. The outliner lets you attach extensive notes to each heading, and the alarm clock includes a timer and stopwatch.

Overall, the program is easy to learn and use. The function you need is usually where you'd expect to find it, and the menus remain consistent from module to module. On-screen, mouse-clickable buttons and easy-to-remember <Alt>-key shortcuts make common options handy. But it's the only program in the roundup that won't let you automate common tasks with macros.

Although they use similar menus, *Eight-in-One's* modules are hardly aware of each others' existence. You can't even send data from the spreadsheet or data base to the word processor—without going through an intermediary file.

Eight-in-One has a competent word processor. You can preview pages, and you can insert PCX-format commercial clip art. But some of the typing conventions are odd; the keystrokes you use to move the cursor, for instance, are neither conventional nor sensible.

The other modules are less powerful. The spreadsheet lacks named ranges, so you can't name a section of a worksheet for easy reference elsewhere, and the simple, nonrelational data base won't even let you view records together in a table so you can browse through and find the ones you need.

Eight-in-One is a so-so value if you crunch numbers or manage data. But its exceptional desktop tools, capable word processor, and low price make it a superb value for light word work.

Enable BP 1.0

PROS: 3-D spreadsheet, pop-up lists aid data entry

CONS: Inconsistent interface, no mouse support, no thesaurus

If you're looking for a powerful spreadsheet, the \$199 *Enable BP* is a bargain—provided you don't mind an old-

Buying Smart: Making an Integrated Choice

If you opt for one inexpensive program to cover all your tasks, you want it to be easy to learn, well integrated, and relatively powerful, at least in the modules you're likely to use most (generally the word processor). You can't expect an integrated module to have the features of a good stand-alone program, but you should demand the features that will help you get your job done.



EASE OF USE

If you can't do your job without digging into a pile of manuals, you've got yourself a productivity problem. Look for logically designed pulldown menus that can help you find what you're looking for. You'll also want keyboard shortcuts and easy-to-record macros to help speed up your work. If you use a mouse, you'll want that supported as well.



INTEGRATION

For all its parts, an integrated program should work as a whole, letting you move—and move your data—easily between modules. Look for a consistent menu structure and the ability to view multiple modules on screen and cut and paste between them. Macros should work across modules, and the word processor should print charts from the spreadsheet and merge information directly from your data base. You should be able to print in the background so you can go about one job while putting another on paper. Finally, the program should integrate with the outside world, reading and writing files from popular, stand-alone programs.



WORD PROCESSOR

Most users process words more than they do numbers or data, so this module is the most important. All the programs reviewed have a spelling checker, but look also for a thesaurus and the ability to select fonts from a menu. You'll also want to see formatting choices on screen as you edit, and preview your page graphically before printing it.



DATA BASE

Managing data is a complex task, and these packages don't pretend to offer the power of a Q&A, let alone a *Paradox*. Still, a good integrated package should give you the tools to create a simple mailing list or contact manager. All the programs offer capable form and report designers, but you'll also want to view multiple records in an on-screen table or one record on a form and to query by form. For instance, you should be able to type 'CA' in the form's state field to get information on everyone who lives in California.

Other tools can come in handy as your data needs grow. If a program offers relational lookups, you'll be able to reference data from one data file in another, for instance, to check a company address that's saved separately from a contact's name.



SPREADSHEET

You'll use the spreadsheet module for budgets, expense accounting, and financial planning. If you can assign names to data ranges, your formulas will be easier to read and write; **TOTAL SALES +(TOTAL SALES*TAX)** certainly makes a lot more sense than

@SUM(B8..B18)+(@SUM(B8..B18)*E64).

Graphs from your spreadsheet data can help you see—and express—the trends in your numbers. Look for several chart formats and, if you need to impress others, access to multiple fonts from inside your charts.



COMMUNICATIONS

If you have a modem, you'll want to let it do its job without making a big fuss. Most important: Look for a dialing directory that lets you place a call by picking a service from a list. You'll also want a script language (or at least a "record" feature) that lets you automate the log-on procedure for each service. An on-line text editor, something all these programs have, will help you move incoming data to other modules while connected. All these programs support the ubiquitous XMODEM file-transfer protocol, so you'll have no trouble sending and receiving files. Only a few of these programs, however, support faster protocols like YMODEM and ZMODEM.



DESKTOP ACCESSORIES

These handy tools let you work all day without leaving your integrated package. Look for a calendar and to-do list for scheduling, an alarm clock to remind you of appointments, and a pop-up calculator for simple math. Other useful tools include a file manager that lets you avoid the DOS prompt and an outliner to help you organize your thoughts before you put them down in your word processor.

FEATURES EVALUATION

Microsoft Works Brings Great Modules Together

Our Best Buy, Microsoft Works, offers easy data exchange and a first-rate word processor.

- Yes
- Na
- ◐ Deficient
- ▲ Limited only by available RAM

	2.03 Eight-in-One	1.0 Enable BP	1.0 Framework XE	1.0 Lotus Works	2.0 Microsoft Works	3.1 PF5: First Choice
Standard features						
Price	\$59.95	\$199	\$149	\$149	\$149	\$149
RAM required	512K	512K	640K	512K	512K	512K
Mouse support	●	○	●	●	●	●
LAN support	○	●	○	●	●	●
Integration						
Maximum files open	1	8	▲	29	8	1
Multiple modules on screen	○	●	●	◐ ²	●	○
Cut/paste between modules	◐ ³	●	●	●	●	●
Macros work across modules	○ ⁴	●	●	●	●	●
Mail merge with data base	◐ ⁵	●	●	●	●	●
Include charts in documents	●	●	●	○	●	●
Read/write DBF files	○	●	●	●	●	○
Read/write WK1 files	◐ ⁶	●	◐ ⁶	●	●	◐ ⁷
Read/write WordPerfect/ Microsoft Word files	○	○	●	○	●	●
Word processor						
Thesaurus	●	○	○	●	●	●
Menu selection of fonts	●	○	○	○	●	○
Print preview	●	○	○	○	●	○
Data base						
Table view	○	●	●	●	●	●
Query from form	●	○	○	○	●	●
Relational lookups	○	●	●	●	●	○
Spreadsheet						
Named ranges	○	●	○	●	●	○
Chart types	6	10	8	5	8	10
Fonts in charts	3	8	1	1	7	4
Communications						
Dialing directory	●	●	◐ ⁸	○	●	●
Script language	○	●	●	●	●	◐ ⁹
Error correction protocols	1	3	5	3	1	1
Terminal emulations	3	3	10	5	2	2
Desktop accessories						
Calendar/to-do list	●	○	●	○	●	○
Alarm clock/reminders/calculator	●	○	○	○	●	○
File manager	●	●	●	○	●	●
Outliner	●	●	●	○	●	●

**BEST
BUY**

¹ 1990 World Class Award winner.

² Only two modules at a time.

³ Not directly from data base or spreadsheet.

⁴ No macros.

⁵ Must convert data base first.

⁶ Import/export rather than direct read/write.

⁷ Can import, but doesn't recognize some common functions.

⁸ Must exit program to add new entry.

⁹ Records log-ons only, no editing.

fashioned interface. Even a simple task like marking a range of cells requires multiple key presses rather than a simple click and drag with the mouse. Mastering that spreadsheet will be of little help if you try using *Enable BP*'s other modules—each one has a different interface.

Learning *Enable* is a challenge. Many tasks—viewing a list of files, for instance—require more keystrokes than they should. To do any but the simplest data base or communications tasks, you need to put on your nerd cap and start programming. And as if to flaunt its complexity, the program comes with nine manuals—a laptop user's nightmare.

Fortunately, the capable spreadsheet handles a full array of powerful number-crunching chores. You can even reference a cell or range from another worksheet to, for instance, read sales commission figures from one file into a sales report in another. And when you import a *1-2-3* or *SuperCalc* file, the macros still work. If you want to produce charts, your options include 3-D charting and exploded pie charts.

For only \$199, *Enable BP* offers plenty of spreadsheet power, but its clunky interface will put off many users.

Framework XE 1.0

PROS: Tightly integrated modules, five communications protocols

CONS: Complex interface, undocumented command language

With its powerful programming language, *Framework XE* is well suited for work groups with at least one technically proficient person. And thanks to the everything-but-the-kitchen-sink communications module, members of those work groups will be able to take their jobs on the road. But going it alone, you'll be hard-pressed to learn *XE*'s arcane interface.

Concepts like *frame trays*, *in and out keys*, and *containing frames* make this program a tough study. For exam-

Is the High End a Dead End?

Susan Lusty

At first glance, a high-end integrated program like *Symphony* or *Framework* may seem like a wise choice. Even though it costs about four or five times as much as the programs in this roundup, it's much cheaper than a collection of separate applications. It's also more powerful than a low-cost integrated package, although still no match for a good stand-alone program.

Yet, high-end integrated packages have some drawbacks. One key reason to buy any integrated package is to get productive as quickly and easily as possible, but high-end integrated packages aren't nearly as easy to use as their less expensive siblings. It's worth noting that *Enable BP* and *Framework XE*, the two programs in this roundup to inherit their interface from high-end software, are the most difficult we reviewed.

One reason for the recent growth of the low-end packages is the boom in laptop sales—these small-footprint programs are perfect for users who don't want to be caught on the road without a full tool kit. But the high-end packages take too much disk space for optimal laptop use—especially if your laptop still lacks a hard drive.

In addition, you'll likely wait a long time between upgrades with the high-end packages. Due to the difficulty of upgrading multi-

ple high-end modules and a lack of sales, most high-end packages have fallen behind the times.

Meanwhile, vendors are actively pursuing (and upgrading) the low end. As noted, *Enable Software* and *Ashton-Tate* have both shipped scaled-back versions of their *Enable* and *Framework* packages, while *Lotus Development*, the maker of *Symphony*, acquired the smaller-scaled *Alpha Works*, renaming it *Lotus Works*.

The growing number of Windows applications, which offer a unified interface and easy data exchange between programs, are hurting the sales of high-end packages. Even DOS users have alternatives: "families" of programs—such as *WordPerfect*, *DrawPerfect*, and *DataPerfect*—that use a common interface and can be linked together with common macros. What's more, stand-alone applications are becoming more inclusive—*WordPerfect*, for instance, has crude spreadsheet abilities, and word processing add-ins are available for *1-2-3*.

With the steady flow of new users, and especially new laptop users, low-end integrated packages have a bright future. But the high end appears to be going...going...gone.

ple, to customize the program by writing a macro that pauses for input, you must master a full programming language—and you have to buy *XE*'s

big brother, *Framework*, for the documentation. When creating a data base, you have to tell *Framework* how many fields you'll need before you name them,

and the option to define field types (text, numbers, dates, and so on) is hidden away on the Numbers menu.

If you can master the front end, you'll find that all of *Framework XE's* pieces fit together nicely. You can cut and paste easily between its multiple on-screen applications, and size and move its windows for a good look at what you're doing.

If you just look at features, *Framework XE's* communications module can't be beat; you even get modem-only support for Novell's Message Handling System (MHS) E-mail standard, so you can phone into your LAN for messages. But if you try the module, you'll find a clumsy design makes it extremely difficult to set up. For instance, to add an entry to the dialing directory, you have to exit *Framework* and use the install program.

Like its big brother, *Framework XE* is well integrated and highly configurable. If your company is already using *Framework*, this low-end version is a good choice for staff with lesser demands. Otherwise, the program's strengths don't offset the learning curve.

Lotus Works 1.0

PROS: Powerful data base and spreadsheet, selectable menu styles

CONS: One font per document, difficult data base searches

Known as *Alpha Works* before Lotus Development acquired it, *Lotus Works* provides strong spreadsheet and data base modules. *Lotus Works* is a fairly good integrated package, but *Microsoft Works* covers the same territory better and is easier to use.

You can get going quickly in *Lotus Works* without using the manual, and if you have problems, the program comes with six months of toll-free technical support, the most generous in the roundup. Another plus: You can switch easily between pulldown and 1-2-3-style menus. If you're sharing data with co-workers' nonintegrated programs, *Alpha Works* is a great choice. Its native spreadsheet and data base file formats are the WKI and DBF standards.

But the program's quirks may slow you down. For instance, you can't use your mouse to mark a block without pressing a key first, and even in the

word processor, the slash key brings up the menu bar—you have to press it *twice* to type a slash. The menus differ more than is necessary from module to module.

Not surprisingly, *Lotus Works* has a very good spreadsheet, complete with named ranges and a full set of functions. Graphing options, on the other hand, are the most limited in the roundup.

The other modules vary in quality, but each lacks an important feature. The communications module supports the speedy YMODEM protocol, but there's no dialing directory. And while the data base has some powerful file-linking capabilities, searching for data is complicated; to find John Jones, you'd have to type `LastName = "Jones" + FirstName = "John"`. The word processor limits you to one font per document.

Lotus Works has a fine spreadsheet and some other good tools. But a disappointing interface and word processor make it only a fair value.

Microsoft Works 2.0



PROS: Easy interface, on-screen windowing, font support, easy data searches

CONS: No dialing directory, background printing, or outliner

Microsoft Works backs up a superb interface with powerful tools. The program bears a family resemblance to *Windows*, so you'll have no trouble switching either way. Fully mousable, *Microsoft Works* also works just fine rodent-free, with easy-to-remember `<Ctrl>`-key shortcuts for most operations. Some of its rivals may offer on-line tutorials, but only *Microsoft Works* lets you take a lesson from the Help menu. Unless you demand top-notch communications, it's a clear Best Buy.

Integration between modules is excellent, with a consistent menu bar serving all modules. To select data for cutting and pasting between modules, you simply drag the mouse or use shifted

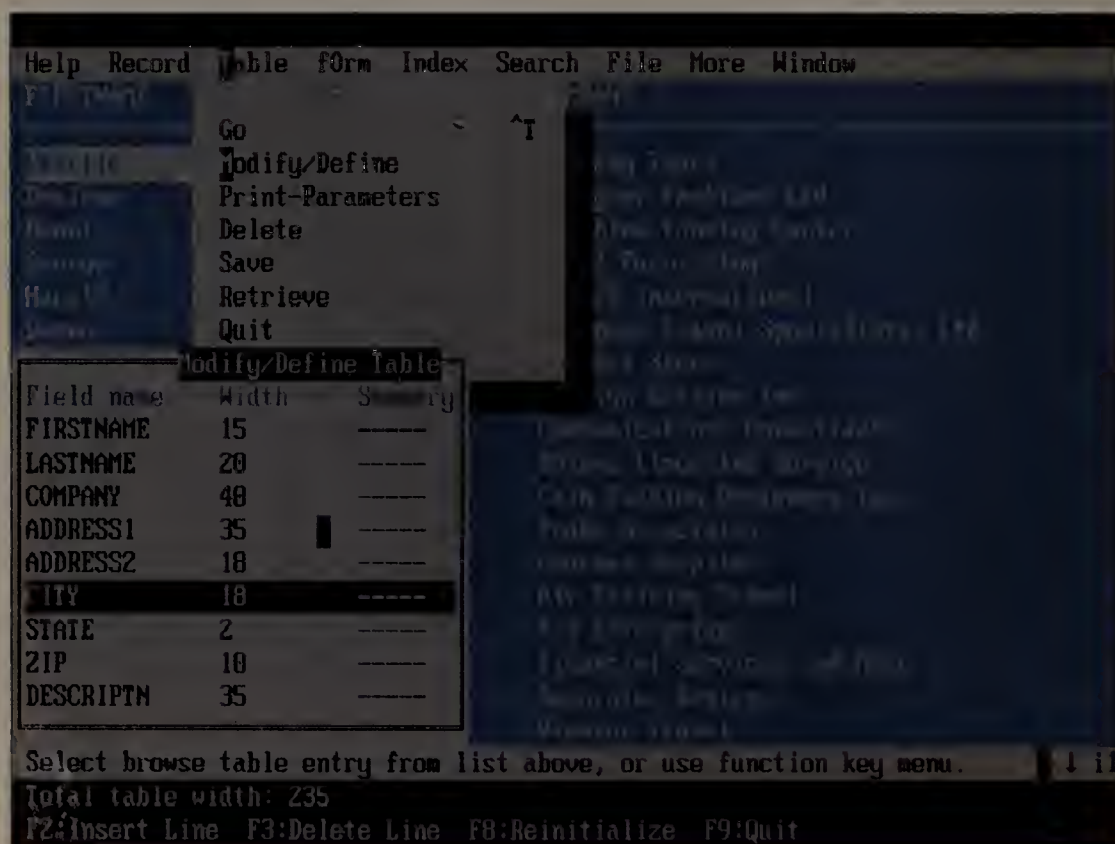

In the Lotus Works data base, you can select fields to display in a table, alter field width, or print the table as a report.

EXECUTIVE SUMMARY

Microsoft Works—and You Win

A minimalist masterpiece, Microsoft Works delivers just the features you need in all the key applications.

Low-cost integrated software is not only a bargain but also a time-saver. By including several applications under one interface umbrella, it helps you learn faster and keep all your tasks tightly linked.

Microsoft Works 2.0 comes out on top as a Best Buy, with its easy-to-use Windows-like interface, full integration, and excellent word processing module. **Eight-in-One**, with solid word processing, a full set of desk accessories, and a low price, comes in a distant second.

	2.03 Eight-in-One	1.0 Enable BP	1.0 Framework XE	1.0 Lotus Works	2.0 Microsoft Works	3.1 PFS: First Choice
Ease of use	Good	Poor	Poor	Fair	Excellent	Good
Integration	Fair	Fair	Excellent	Fair	Good	Good
Word processor	Good	Fair	Fair	Fair	Excellent	Fair
Data base	Fair	Fair	Fair	Good	Good	Good
Spreadsheet	Fair	Excellent	Fair	Good	Excellent	Poor
Communications	Fair	Good	Good	Good	Fair	Fair
Desktop accessories	Excellent	Poor	Fair	Poor	Good	Poor
Overall value	Good	Fair	Fair	Fair	Excellent	Fair
					BEST BUY	
Reader service no.	610	611	612	613	614	615

How we rate integrated packages

We base our scores on information in the Features Evaluation table, combined with an assessment of the quality of each module.

Ease of use considers how easy it is both to learn the program and to use it once you're experienced. An Excellent rating demands mouse support, logical menus, and flexibility in using the keyboard or mouse.

Integration assesses how well the various modules work together and how easy it is to share data between modules and with other programs. To receive an Excellent rating, a package's menus and commands must change very little from module to module, and macros should work across all modules. The program must display multiple modules on screen, do mail merge straight from the data base module to the word processor, and directly read and write several popular file formats.

Word processor evaluates the tools provided for creating, editing, formatting, and printing text. To earn an Excellent rating, a package must offer a well-designed editing environment with a spelling checker and thesaurus, let you control your printer's fonts easily, and provide a graphic preview of your page before you print it.

Data base considers the program's handling of structured and sortable data, such as a mailing list. An Excellent rating means a program offers easy form and report design tools, a table view of your data, relational lookups, and querying from a form.

Spreadsheet rates the program's ability to calculate, analyze, and graph numeric data. To receive an Excellent rating, a program must let you name ranges of cells. It must also let you create at least eight chart formats, and offer a minimum of four fonts for titles and labels.

Communications ratings consider how well you can communicate by modem or network. An Excellent rating requires a dialing directory that lets you add new entries without exiting the program, at least one file transfer protocol besides XMODEM, the ability to edit text while on line, a script language, and at least five terminal emulations.

Desktop accessories evaluates additional tools that can increase productivity. An Excellent rating demands a pop-up calculator, a calendar, a to-do list, an alarm clock with reminders, an outliner, and a DOS file manager.

Overall value is averaged from the above ratings, with extra weight given to ease of use and, to a lesser extent, integration and word processing. The price of the program is also taken into consideration.

cursor keys. Sharing data with other programs is not so easy; the program can't handle or directly import documents in any popular word processing format—even *Microsoft Word*.

The word processor is by far the best of this group's, with full font control and easy block operations. The data base may not have the file-linking power of *Lotus Works*, and the spreadsheet lacks *Enable's* 3-D references and ten chart

types, but both modules offer everything else you'll need, and they're easy to use.

You won't be so happy with the communications module, however. There's no dialing directory, limited terminal support, and just one transfer protocol.

These flaws aside, *Microsoft Works* is an ideal Best Buy. It's perfect for novices, laptop users, and just about anyone who needs an integrated package.

PFS:First Choice 3.1

PROS: Most modules easy to use, strong integration, good data base

CONS: Poor spreadsheet, few desktop tools

With its easy interface and tight integration, *PFS:First Choice* is a quick start. But the program's unremarkable word processor and eccentric spreadsheet limit it to a fair value.

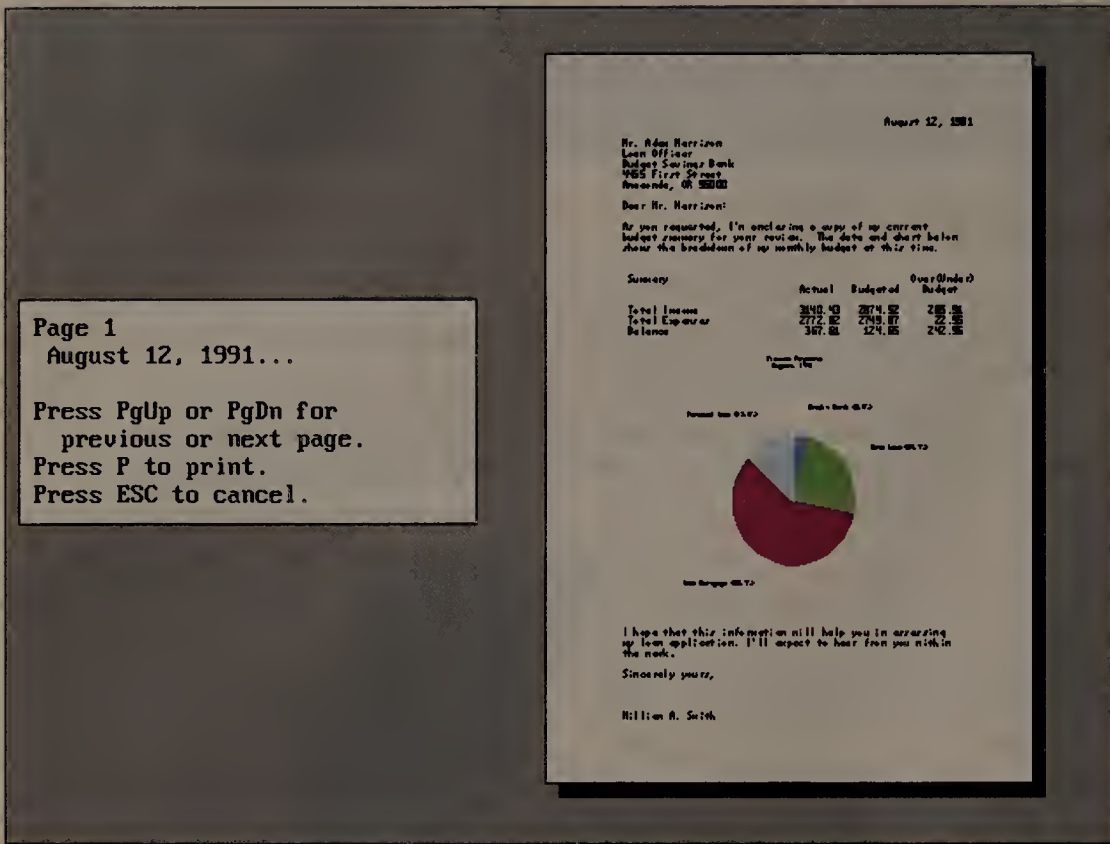

Microsoft Works' page preview makes it easy to see the final format of any document, replete with charts and pasted-in spreadsheet data.

The name *PFS* has long meant *easy to use*, and *First Choice* lives up to that reputation. Mouse support, well-designed pulldown menus, context-sensitive help and logical <Alt>-key shortcuts make it easy to get up to speed. The program is well integrated, with consistent menus and macros across modules,

but you can't open multiple windows on the screen.

Applications are limited, even for novices. For instance, the word processor restricts you to just one font per document, and you can't even insert a blank line without a menu command.

First Choice's spreadsheet will drive

you crazy. You can't put numbers or formulas in the left-hand column, you address cells with codes like C1R1—much clumsier than the conventional A1—and even entering a formula is confusing. While it can import 1-2-3 files, *First Choice* doesn't understand the ubiquitous @SUM function.

Beginning users might appreciate *First Choice's* easy menus. But they will soon balk at its limited word processor, funky spreadsheet, and weak desktop tools.

Putting It All Together

Making a good integrated program is apparently a difficult job—most of the programs reviewed here are only fair. Fortunately, we did find one program we can recommend without hesitation: *Microsoft Works'* friendly face and first-class word processor make it an unbeatable Best Buy. ☺

George Campbell is a contributing editor and Susan Lusty an assistant editor for PC World.

For more information about all products in this article, circle reader service no. 903.

WHERE TO BUY

Eight-in-One 2.03
Spinnaker Software Corp.
201 Broadway
Cambridge MA 02139
800/323-8088,
617/494-1219 (fax)
LIST PRICE: \$59.95
REQUIREMENTS:
512K, DOS 2.1 or later version, two floppy drives
TECHNICAL SUPPORT:
unlimited, toll number, M-Th 10-5, F 10-4
OTHER SUPPORT:
none
Reader service no. 610

Enable BP 1.0
Enable Software Inc.
Northway Ten
Executive Park

Ballston Lake, NY
12019-1519
800/888-0684
LIST PRICE: \$199
REQUIREMENTS:
512K, DOS 2.1 or later version; hard disk recommended
TECHNICAL SUPPORT:
toll number, M-F 9-7
OTHER SUPPORT: BBS, extended support with toll-free number at extra cost
Reader service no. 611

Framework XE 1.0
Ashton-Tate Corp.
20101 Hamilton Ave.
Torrance, CA
90509-2833
800/437-4329,
213/329-9989
LIST PRICE: \$149

REQUIREMENTS:
640K, DOS 2.0 or later version, two floppy drives
TECHNICAL SUPPORT:
unlimited, toll number, M-F 6-4:30
OTHER SUPPORT: BBS, CompuServe and GENie forums, extended support at extra cost
Reader service no. 612

Lotus Works 1.0
Lotus Development Corp.
55 Cambridge Pkwy.
Cambridge, MA
02142
800/635-6887
LIST PRICE: \$149
REQUIREMENTS:

512K, DOS 2.0 or later version, two floppy drives
TECHNICAL SUPPORT:
first six months unlimited, toll-free number, M-F 8:30-8
OTHER SUPPORT:
extended support at extra cost
Reader service no. 613

Microsoft Works 2.0
Microsoft Corp.
One Microsoft Way
Redmond, WA
98052-6399
800/426-9400
LIST PRICE: \$149
REQUIREMENTS:
512K, DOS 2.0 or later version, two floppy drives
TECHNICAL SUPPORT:
unlimited, toll number,

M-F 6-5:30
OTHER SUPPORT:
CompuServe and GENie forums
Reader service no. 614

PFS:First Choice 3.1
Spinnaker Software Corp.
201 Broadway
Cambridge MA 02139
800/323-8088,
617/494-1219 (fax)
LIST PRICE: \$149
REQUIREMENTS:
512K, DOS 2.1 or later version, two floppy drives
TECHNICAL SUPPORT:
unlimited, toll number, M-Th 10-5, F 10-4
OTHER SUPPORT:
none
Reader service no. 615



"SURF'S UP... AND SO IS MY BUSINESS"

—STEVE CATHEY
President
West Coast Sales Organization
Solana Beach, California



"We sell products from the country's leading manufacturers of surfing related products. In a few short years we grew to where our software wasn't able to keep up with us. That's why we gave up on Microsoft Works™ and turned to Open Access III from SPI. It meets our needs now and we are confident it will meet our needs well into the future!"

If your business is outgrowing your software, now's the time to move up to Open Access III. The fully integrated multi-function software package with the features you demand and power that won't let you down.

Database. *"Open Access III gives us the relational database power we need to effectively manage our business. Microsoft Works forced us to create multiple customer files due to its limited storage capabilities."* Open Access III lets you maintain a virtually unlimited number of records and report files. And Open Access III's easy-to-use programming language and large selection of third-party applications

ensure you will always be able to meet your future application requirements.

Spreadsheet. *"Heavy-duty data analysis is easy, since the spreadsheet offers direct query access to database files, unlimited file linking and built-in goal seeking."* With Open Access III's virtual memory management, the size of your spreadsheet is limited only by the size of your hard disk, not by the size of your RAM.

Word Processor. *"No more data translation hassles — OA III's query capability allows us to directly select database records in any order for instant mail merge."* Now you can get custom high-quality output without all the extra work.

Communications and Desk Accessories. *"Since Open Access III is network-ready for four users, it's perfect for our office, while the built-in E-Mail is great for keeping in touch when we're out selling."* In addition to its powerful Communications module, Open Access III includes a full set of desk

accessories you'll use every day including an appointment scheduler, business cards, calendar, stopwatch, notepad and calculator.

Move up to Open Access III. It's the clear choice when you need a multi-function software solution that is easy to use, and your business demands software with power to spare.

Make a move today to protect your future. To protect your business. Move up to Open Access III.

FREE DEMONSTRATION DISK OFFER

If you would like to experience the power of Open Access III, call today for a free self-running demonstration disk and the name of an Open Access III dealer near you.

1-800-937-4774
1-619-450-1526



Software Products International
9920 Pacific Heights Blvd
San Diego, CA 92121-4330

Open Access III is a registered trademark of Software Products International. All other products mentioned are trademarks or registered trademarks of their respective holders.

THE POWER THAT MOVES YOU...

ZENITH DATA SYSTEMS UPSETS THE BALANCE



**MastersPort
386SL**

The fully-featured notebook that sets the standard for the Intel 386™ SL microprocessor. Its *Premier System Management*—with two separate resume modes—lets you hold work in active memory for weeks at a time.



INTRODUCING 5 NEW PORTABLES FROM ZENITH DATA SYSTEMS.

The conventional way to look at portable power is from the PC's perspective. The processor. The speed. The memory. At Zenith Data Systems, we believe the proper perspective is yours. How easily you can take full advantage of the power within your PC. A philosophy exemplified by our five new portables. Our breakthrough MastersPort 386SL. The first notebook you can use, and use, without ever thinking about battery life. Our SupersPort battery-powered i486™ laptops — the first ever. Both so advanced, they just might replace your desktop. Plus 286 and 386SX notebooks that are titans on performance. So if you want power without limits, these are the portables to move to. Unquestionably from Zenith Data Systems. For more information and the name of your nearest Zenith Data Systems Medallion Reseller, call **1-800-523-9393** in North America.

OF POWER.

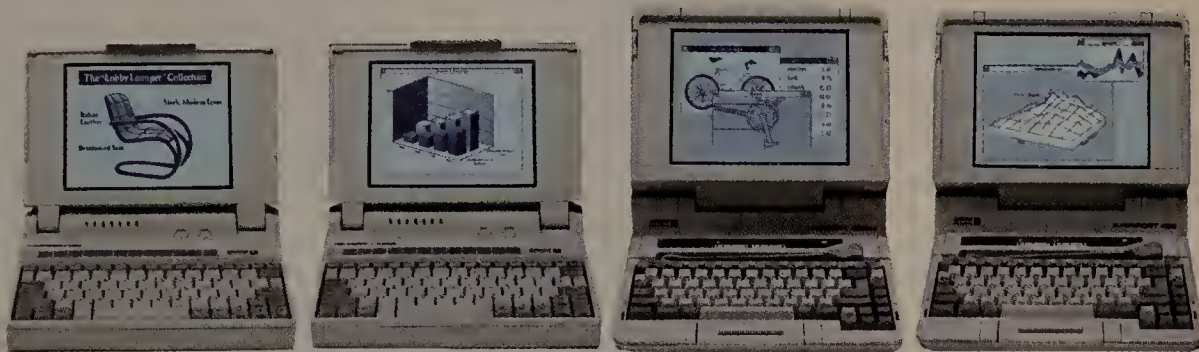

MastersPort 286 MastersPort 386SX SupersPort 486SX SupersPort 486

LOOK INTO THE POWER OF 5 NEW PORTABLES

	MastersPort™ 286	MastersPort 386SX	MastersPort 386SL	SupersPort® i486SX	SupersPort i486
Processor — Speed	286 — 12/6MHz	386SX — 20/10MHz	386SL — 20/5/0MHz	486SX — 20/10MHz	486 — 25/12.5MHz
Co-Processor	80C287 socket	80387SX socket	80387SX socket	Upgradeable to 486-20MHz	Integrated
Memory (Std./Max.)	1MB/2MB	2MB/4MB	2MB/8MB (64K cache)	4MB/16MB	4MB/16MB
Hard Disk Drive	30MB	60MB	60MB	120MB	120MB
LCD/Size	Backlit/8.85"	Backlit/8.85"	Backlit/8.85"	Edgelit/10.7"	Edgelit/10.7"
Video/Gray Scales	VGA/16	VGA/16	VGA/32	VGA/64	VGA/64
Power Management	<ul style="list-style-type: none"> • Suspend/Resume • Sleep mode • Low battery operation 	<ul style="list-style-type: none"> • Suspend/Resume • Sleep mode • Low battery operation 	Premier System Management™ <ul style="list-style-type: none"> • Standby/Resume • Rest/Resume • Panic Save • Unattended communications 	Intelligent Power Management™	Intelligent Power Management
Software	MS-DOS® included	MS-DOS included	MS-DOS pre-installed; Microsoft® Windows™ v. 3.0 included	MS-DOS and Microsoft Windows v. 3.0 pre-installed	MS-DOS and Microsoft Windows v. 3.0 pre-installed
Weight (with battery)	6.6 lbs.	6.6 lbs.	6.8 lbs.	15 lbs.	15 lbs.



Groupe Bull

Intel386 and i486 are trademarks of Intel Corporation. MastersPort, SupersPort, Premier System Management and Intelligent Power Management are trademarks of Zenith Data Systems Corporation. MS-DOS, Microsoft and Windows are trademarks of Microsoft Corporation.

Copyright © 1991 Zenith Data Systems Corporation

Circle 290 on reader service card

P E R S

—
CATHY
SMITH

—
DANIEL
TYNAN



In a perfect world, every user would have access to a high-speed laser printer. But let's get real—most users aren't networked, and even an "affordable" laser like Hewlett-Packard's LaserJet IIP can run you almost \$1000, once you add necessities like paper trays and extra RAM. If you run a small business or need to outfit several users in your work group with printers, you should consider two older yet sometimes wiser choices: dot matrix and ink jet printers.

A 24-pin dot matrix printer offers high-quality text printing at a price between \$350 and \$1000, plus wide-document and multipart-form printing—two features you simply can't get

from a laser. If you need to print graphics too, ink jets provide laserlike output as well as quiet operation and greater portability (see the sidebar "Affordable Graphics Printers—Pretty in Ink"). Dot matrix and ink jet printers can also give you color output on the cheap (see "Buyers' Guide: Color Peripherals," June 1991).

We've uncovered 50 monochrome 24-pin and ink jet printers you can buy for less than \$1000. This Buyers' Guide shows you how to find the right printer, whether you're looking for a low-cost machine to put on your desk or a somewhat more expensive wide-carriage model for your work group.

P R I N

O N A L



In the laser printer era, the 24-pin dot matrix printer is doing more than holding its own—it's performing business tasks no laser can. And ink jets make great silent partners.

Pinning Down the Differences

Why buy a dot matrix printer? Three reasons: multipart forms, wide-carriage printing, and bargain prices. Only a dot matrix printer can give you draft and letter quality text for under \$500—or \$600 and up if you need a wide-carriage model for printing big (11-by-17-inch) spreadsheets.

Dot matrix printers work by striking an inked ribbon with a series of pins. Draft mode uses fewer pins per character, resulting in text printing speeds up to three times faster than with letter quality (LQ) mode but far less readable output. In LQ mode, most 24-pins produce text whose quality approaches

laser printers', fine for in-house documents and most business correspondence. Graphics are another story—you're likely to see jaggy curves and visible bands across solid areas. Still, a 24-pin is handy for quick drafts of charts whose final destination is the office laser.

Unless you shell out big bucks for a high-speed line printer (not included here), your dot matrix device will generally be slower than even a 4-page-per-minute laser. The maximum speed ratings shown in the table (measured in characters per second, or cps) are vendor estimates—expect actual performance to be 15 to 20 percent slower.

T E R S

PRINTERS WITH IMPACT—24-PIN MODELS UNDER \$1000

Manufacturer	Product	List price		Rated speed (LQ/draft, cps)	Buffer size (standard/ maximum)	STANDARD FEATURES			TYPOGRAPHICAL FEATURES		PAPER HANDLING	
		Narrow carriage	Wide carriage			Resident fonts	Font cartridges available	Supports downloaded fonts	Paper advance at end of job	Form parking		
ADVANCED MATRIX TECHNOLOGY	Accel-242	\$425	\$625	75/225	8K/32K	4	3	Y	Y	Y		
AEG OLYMPIA	NP 80-24E	\$499		67/200	24K/56K	6	1	Y	Y	Y		
	NP 136-24		\$699	80/240	24K/56K	6	1	Y	Y	Y		
ALPS AMERICA	Allegro 500	\$499		60/180	12K/44K	7	0	Y	Y	Y		
	Allegro 500XT		\$799	83/250	23K/55K	7	0	Y	Y	Y		
	ALQ224/GX	\$799	\$999	93/280	23K/64K	5	1	Y	Y	Y		
BROTHER INT'L	M-1324	\$399		72/216	64K/96K	7	1	Y	Y	Y		
	M-1B24L	\$749	\$949	75/225	64K/96K	5	1	Y	Y	Y		
CITIZEN AMERICA	GSX-140	\$499	\$649	64/192	BK/40K	6	0	Y	Y	Y		
C-TECH ELECTRONICS	ProWriter C-510	\$639	\$749	80/240	26K/26K	3	14	Y	Y	Y		
	ProWriter C-610+	\$799		80/240	26K/26K	3	14	Y	Y	Y		
DATAPRODUCTS	9034	\$899	\$1099	83/300	32K/32K	2	4	N	N	Y		
DIGITAL EQUIPMENT	LA 70	\$499		40/200	2K/2K	1	0	Y	Y	Y		
	LA 75	\$835		42/250	2K/2K	1	2	Y	Y	Y		
EPSON AMERICA	LQ-200	\$399		64/192	BK/40K	10	0	Y	N	N		
	LQ-570	\$499 ²		84/252	BK/40K	12 ³	0	Y	Y	Y		
	LQ-B70	\$749 ²	\$1099 ²	110/330	BK/40K	12 ³	0	Y	Y	Y		
FACIT	B 2400	\$699	\$849	78/240	26K/26K	2	14	Y	Y	Y		
IBM	PS/1	\$449		53/92	5K/5K	4	0	N	N	Y		
	ProPrinter X24E	\$859	\$1099	96/288	14K/14K	4	0	Y	Y	Y		
MANNESMANN TALLY	MT B2	\$499		64/192	11K/11K	3	0	Y	Y	Y		
	MT 130/24	\$899	\$999	150/300	17K/32K	7	4	Y	Y	Y		
NEC TECHNOLOGIES	Pinwriter P3200	\$429	\$599	72/216	BK/BK	7	0	N	Y	Y		
	Pinwriter P6200	\$749	\$999	100/300	80K/BOK	8	8	N	Y	Y		
OKIDATA	Microline 380	\$349		60/180	BK/8K	6	0	Y	Y	Y		
	Microline 390 Plus ⁵	\$699	\$949	90/270	23K/40K	6	1	Y	Y	Y		
OLIVETTI OFFICE USA	DM124	\$499		50/200	40K/40K	13	0	Y	N	Y		
PANASONIC	KX-P1123	\$369.95		63/240	10K/42K	7	0	Y	Y	Y		
	KX-P1124i ⁴	\$499.95		100/300	12K/44K	11	0	Y	Y	Y		
	KX-P1654		\$949.95	125/375	42K/72K	11	0	Y	Y	Y		
SEIKOSHA	LT-20	\$499		60/180	1K/12K	1	8	Y	Y	N		
	SL-90 Plus	\$549		80/240	12K/12K	9	0	Y	Y	Y		
	SL-230		\$998	92/277	5K/64K	9	0	Y	Y	Y		
STAR MICRONICS	NX-2410 Multi-Font	\$399		75/225	7K/39K	8	3	Y	N	Y		
	NX-2420 Multi-Font	\$449		100/250	7K/39K	10	6	Y	Y	Y		
	XB-2410 Multi-Font	\$699	\$899	100/300	27K/155K ⁷	17	0	Y	Y	Y		
	XB-2420 Multi-Font	\$799	\$999	125/375	29K/157K ⁷	27	6	Y	Y	Y		
TANDY	Tandy DMP 240	\$549.95		64/192	BK/40K	5	0	Y	Y	Y		
	Tandy DMP 302	\$599		75/270	32K/32K	7	0	Y	Y	Y		
	Tandy DMP 2104		\$599	80/240	2K/32K	2	0	Y	Y	Y		
	Tandy DMP 2103		\$899	90/270	32K/32K	7	0	Y	Y	Y		
TOSHIBA AMERICA INFORMATION SYSTEMS	ExpressWriter420	\$499	\$699	80/240	2BK/2BK	5	0	Y	Y	Y		
UNISYS	AP1337	\$699	\$949	90/270	BK/40K	8	1	Y	Y	Y		

¹ Information unavailable from vendor.

² Price subject to change.

³ Two fonts are scalable from 8 to 32 points.

⁴ Extra-cost option.

⁵ 1989 Best Buy.

⁶ 1990 World Class Award Winner.

⁷ Wide-carriage model's buffer is bigger.



FRONT PANEL CONTROLS

Optional sheet feeder	Single cut-sheet feed	Multipart forms (maximum parts)	Envelopes/labels	Pitch	Font selection	Line spacing	Micro linefeed	Margins	Warranty (years)	Mean time between failures at hours of printing per day	Reader service number
Y	Y	3	Y/Y	Y	Y	Y	Y	Y	1	5000 at 2	645
Y	Y	3	Y/Y	Y	Y	Y	N	Y	1	6000 at 1.6	646
Y	Y	3	Y/Y	Y	Y	y	N	Y	1	6000 at 1.6	646
Y	Y	4	Y/Y	Y	Y	Y	Y	N	1	6250 at 1.6	647
Y	Y	4	Y/Y	Y	Y	Y	Y	N	1	7500 at 1.6	647
Y	Y	5	Y/Y	Y	Y	Y	N	N	1	7500 at 1.6	647
Y	Y	3	N/Y	Y	Y	Y	N	Y	1	4000 at 2	648
Y	Y	4	N/Y	Y	Y	Y	N	Y	1	6000 at 2	648
Y	Y	4	Y/Y	Y	Y	Y	Y	Y	2	4000 at 6	649
Y	Y	4	Y/Y	Y	Y	Y	Y	Y	2	6000 at 2	650
Y	Y	5	Y/Y	Y	Y	Y	Y	Y	2	5800 at 2	650
Y	Y	4	N/Y	Y	Y	Y	Y	N	1	5000 at 1	651
Y	Y	3	Y/Y	Y	N	Y	N	N	1	1	652
Y	Y	4	Y/Y	Y	N	Y	N	N	1	1	652
Y	Y	3	Y/Y	N	Y	N	Y	N	2	4000 at 2	653
Y	Y	4	Y/Y	N	Y	N	Y	N	2	4000 at 2	653
Y	Y	4	Y/Y	Y	Y	N	Y	N	2	4000 at 2	653
Y	Y	4	Y/Y	Y	Y	Y	Y	Y	1	1	654
Y	4	4	Y/Y	N	Y	N	N	Y	1	1	655
Y	Y	4	Y/Y	N	N	N	N	N	1	1	655
Y	Y	3	Y/Y	Y	Y	N	N	N	1	2000 at 2	656
Y	Y	6	Y/Y	Y	Y	Y	Y	N	1	7800 at 2	656
Y	Y	3	Y/Y	Y	Y	N	Y	Y	1	4000 at 2	657
Y	Y	4	Y/Y	Y	Y	N	Y	Y	1	6000 at 2	657
Y	Y	3	Y/Y	Y	Y	Y	Y	Y	1	4000 at 2	658
Y	Y	4	Y/Y	Y	Y	Y	Y	Y	1	5000 at 2	658
Y	Y	3	Y/Y	Y	Y	Y	N	Y	1	5000 at 4	659
Y	Y	4	Y/Y	Y	Y	Y	Y	Y	2	4000 at 2	660
Y	Y	4	Y/Y	Y	Y	Y	Y	Y	2	5000 at 2	660
Y	Y	4	Y/Y	Y	Y	Y	Y	Y	2	6000 at 2	660
N	Y	3	N/Y	N	N	N	N	N	2	4000 at 1	661
Y	Y	3	N/Y	Y	Y	N	N	Y	2	4000 at 1	661
Y	Y	4	Y/Y	Y	Y	N	N	Y	2	5068 at 1	661
Y	Y	3	N/Y	Y	Y	N	Y	N	2	4000 at 6	662
Y	Y	5	Y/Y	Y	Y	N	Y	N	2	5000 at 4.8	662
Y	Y	4	Y/Y	Y	Y	Y	Y	Y	2	4000 at 6	662
Y	Y	5	Y/Y	Y	Y	Y	Y	Y	2	7000 at 4.8	662
Y	Y	4	Y/Y	Y	Y	Y	N	Y	1	5000 at 2	663
Y	Y	4	Y/Y	Y	Y	Y	Y	Y	1	5000 at 2	663
N	Y	4	Y/Y	Y	Y	Y	Y	Y	1	6000 at 2	663
Y	Y	4	Y/Y	Y	Y	Y	Y	Y	1	5000 at 2	663
Y	Y	4	Y/Y	Y	Y	Y	Y	Y	2	6000 at 2	664
Y	Y	5	Y/Y	N	Y	Y	N	N	1	6000 at 2	665

For more information about all products in this table, circle reader service no. 904.

If all you need is draft output, it doesn't matter what fonts come with the printer. If you want to print out correspondence and reports, however, you'll want at least three built-in fonts, plus the ability to add more via optional font cards or downloading. (Most 24-pins come with a limited supply of typefaces in fixed sizes, though Epson's new LQ-570 and LQ-870 let you scale fonts from 8 to 32 points.) Usually, the bigger the print buffer, the better. You'll want at least an 8K buffer to spool large print jobs; demand

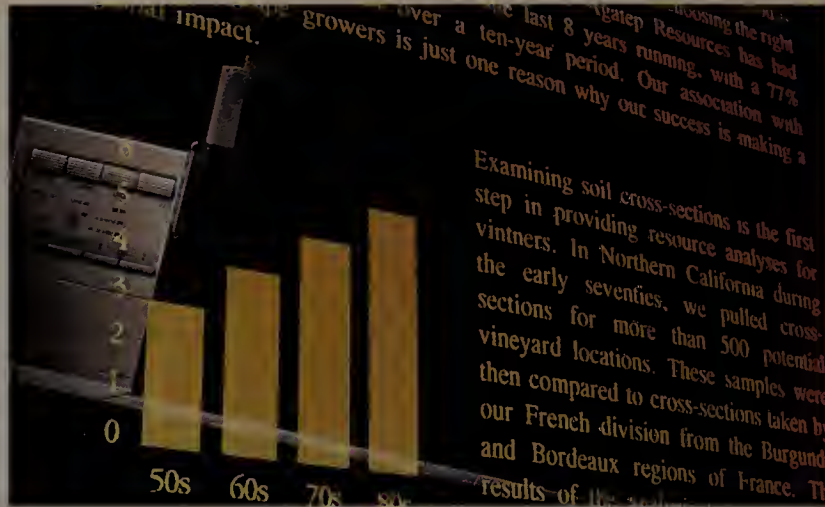

32K or more if you want to download software-based fonts.

If you value your sanity,

top-notch paper handling is a must. Automatic paper advance means you won't need to roll the fanfold forward and

back every time you tear off a sheet. Form parking saves you from having to unload the fanfold paper every time you need to print on a single sheet of letterhead. Also look for the capability to print envelopes and labels—or be prepared to keep a typewriter nearby.

Even the best laser can't print on multipart forms. Most shipping labels, invoices, and other standard forms require an impact device that can leave a strong impression; ideally, your 24-pin printer should be able to handle at least four-part forms (one original plus

KNOW YOUR OPTIONS

The Right Personal Printer

Sometimes the best printer for your desktop isn't the most expensive. Whether you choose a dot matrix, an ink jet, or a laser depends on the kind of print jobs you do.

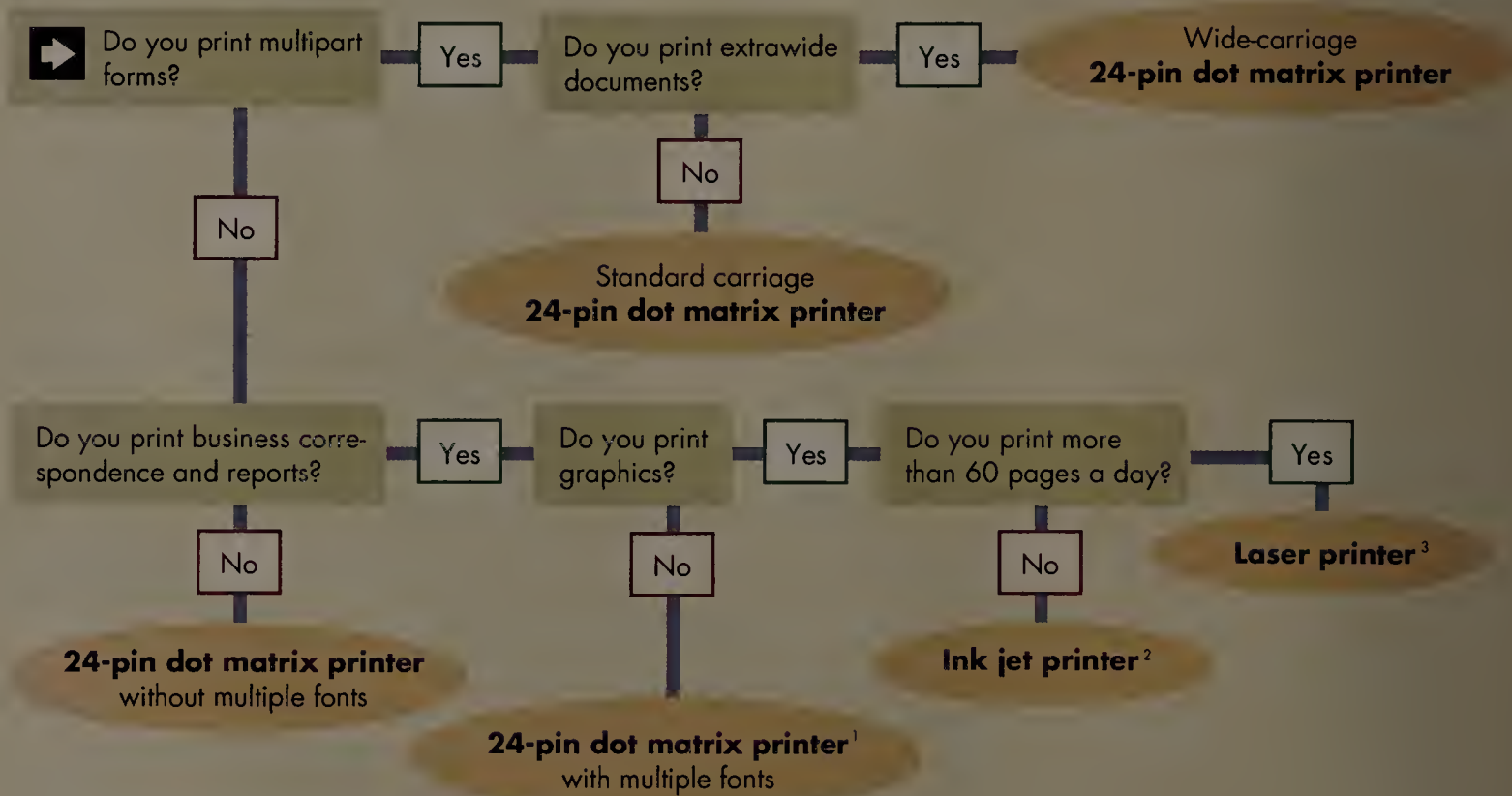

¹ Printed on Epson's LQ-570.

² Printed on Hewlett-Packard's DeskJet 500.

³ Printed on Hewlett-Packard's LaserJet IIIID.

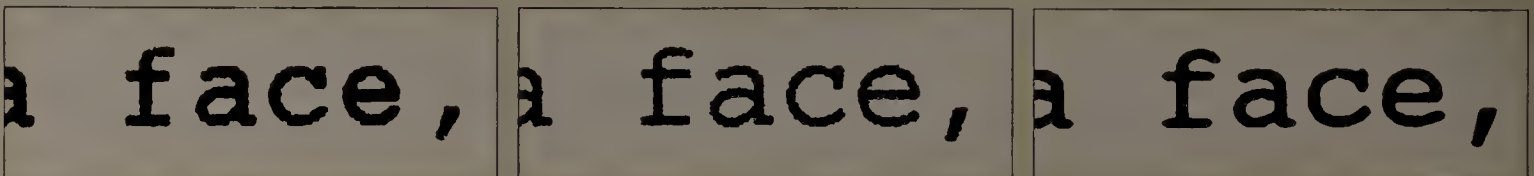

AFFORDABLE GRAPHICS PRINTERS—PRETTY IN INK

MANUFACTURER Printer	List price	STANDARD FEATURES			TYPOGRAPHIC FEATURES			PAPER HANDLING			Reader service number
		Rated speed (LQ/draft, in cps)	Buffer size (standard/ maximum)	Graphics resolution (dpi)	Resident fonts	Font cartridges available	Supports downloaded fonts	Optional sheet feeder	Envelopes/ labels	Warranty (years)	
CANON USA											
BJ-10e	\$499	83/142	37K/37K	360	8	0	Y	Y	Y/Y	1	666
BJ-300	\$799	300/600	30K/158K	360	18	3	Y	Y	Y/Y	1	666
BJ-330 ¹	\$949	300/600	30K/158K	360	18	3	Y	Y	Y/Y	1	666
EASTMAN KODAK											
Kodak Diconix 150 Plus	\$519	52/180	2K/2K	192	13	0	N	N	N/N	1	667
HEWLETT-PACKARD											
HP DeskJet 500	\$729	120/240	16K/16K	300	4	20	Y	N	Y/Y	3	668
IBM											
ExecJet ¹	\$1099	150/300	30K/128K	360	18	3	Y	Y	Y/Y	1	669
OLIVETTI OFFICE USA											
JP 350	\$729	120/360	40K/256K	300	3	16	Y	Y	Y/Y	1	670

¹Wide-carriage model.

For more information about all products in this table, circle reader service no. 905.

Most of us can't live by text alone. And while you can print a pie chart or clip art on a dot matrix, you may be less than thrilled with the results. When you need to print graphics as well as text and can't afford a laser, an ink jet is an excellent compromise.

Though a tad more expensive than their dot matrix cousins, ink jets are also generally smaller and quieter—perfect for cramped desktops where the printer sits right next to the phone. On the other hand, they can't print multipart forms, and only the Canon BJ-330 and the IBM ExecJet can handle wide paper.

Like dot matrix printers, ink jets print pages one line at a time, and at comparably slow speeds. But instead of striking an inked ribbon, an ink jet sprays fine streams of liquid ink onto the page, creating laserlike text and graphics.

The primary issue is output quality, which can vary depending on the type of paper. With some paper, the ink seeps into the fibers, creating fuzzy text and wrinkled solid areas. Before you buy, be sure to print out samples

on the types of paper you're likely to use.

Output durability is also key. In the old days, if an ink jet page got wet, it looked like a Jackson Pollock painting—a series of blotchy smears. HP's new water-resistant inks reduce the problem for DeskJet users, but for others the quality varies. To gauge smearing, lick your thumb and rub it across a freshly inked page.

Most of the rules for buying dot matrix printers also apply to ink jets. You'll want a healthy selection of font options, but since all the ink jets handle single cut sheets, paper handling and control panel options are generally less important. All the printers deliver solid software compatibility by offering Epson or IBM emulation.

Finally, consider portability. The Canon BJ-10e and the Kodak Diconix 150 Plus weigh in at under 5 pounds each—slightly less than the lone dot matrix luggable, the Seikosha LT-20. For printing on the road (as well as on the desktop), an ink jet may be your best bet.





STAN MUSILEK

three copies).

All the printers listed here provide either Epson or IBM emulation—a virtual guarantee that your software applications can send copy to them. But Murphy's Law guaran-

tees that just when the deadline is tightest, you'll need to do something that your application can't handle. Look for front-panel controls that let you set pitch, font, line spacing, and margins. Micro line-

feed, which lets you adjust paper position with greater precision, is an especially handy feature.

Finally, look for a printer that will last. Your only indicator is its *mean time between*

failures rating—the vendor's estimate of how long the printer will work before requiring service, based on a specified amount of use per day. For example, "4000 at 2" means the printer should run at least 4000 hours without a hitch if you use it 2 hours a day.

Dot's All, Folks

Smart shoppers know that sometimes old, proven technology has its advantages. If you need an affordable personal printer—and especially if forms and wide-carriage printing are part of your picture—a 24-pin model will please you and your wallet. ☉

Cathy Smith is an editorial assistant and Daniel Tynan an associate editor for PC World.

WHERE TO BUY

Advanced Matrix Technology

765 Flynn Rd.
Camarillo, CA 93012
800/637-7878,
805/484-5282 (fax)

AEG Olympia

1330 River Bend #600
Dallas, TX 75247
214/631-1031,
214/288-1764 (fax)

Alps America

3553 N. First St.
San Jose, CA 95134
800/825-2577

Brother Int'l Corp.

200 Cottontail Ln.
Somerset, NJ 08875
908/356-8880 ext.
4504,
201/469-4415 (fax)

Canon USA

One Canon Plaza
Lake Success, NY
11042
516/488-6700

Citizen America Corp.

2450 Broadway #600
P.O. Box 4003
Santa Monica, CA
90411-4003
213/453-0614,
213/453-2814 (fax)

C-Tech Electronics

2515 McCabe Way
P.O. Box 19673
Irvine, CA 92713
800/347-4017,
714/757-4533 (fax)

DataProducts

6219 DeSoto Ave.
P.O. Box 746
Woodland Hills, CA
91365-0746
818/887-8000,
818/887-3816 (fax)

Digital Equipment Corp.

146 Main St.
Maynard, MA
01754-2571
508/493-5111

Eastman Kodak Co.

901 Elmgrove Rd.
Rochester, NY 14653
800/242-2424,
716/726-3108

Epson America Inc.

20770 Madrona Ave.
Torrance, CA 90503
800/922-8911,
800/289-3776

Facit

University Center
400 Commercial St.
Manchester, NH
03108-9549
603/647-2700,
603/647-2724 (fax)

Hewlett-Packard Co.

19310 Pruneridge Ave.
Cupertino, CA 95014
800/752-0900,
208/344-4809 (fax)

IBM

Old Orchard Rd.
Armonk, NY 10504
800/426-2468

Mannesmann Tally Corp.

8301 S. 180th St.
Kent, WA 98032
800/843-1347,
206/251-5520 (fax)

NEC Technologies

1414 Massachusetts Ave.
Boxborough, MA
01719
800/632-4636

Okidata

532 Fellowship Rd.
Mount Laurel, NJ
08054
800/654-3282
609/778-4184 (fax)

Olivetti Office USA

765 U.S. Hwy. 202
Bridgewater, NJ
08807-0945
800/527-2960,
908/526-8200,
908/526-8405 (fax)

Panasonic

Two Panasonic Way
Secaucus, NJ 07094
800/346-4768

Seikosha

10 Industrial Ave.
Mahwah, NJ 07430
800/338-2609,
201/818-9175 (fax)

Star Micronics

420 Lexington Ave.
#2702
New York, NY 10170
800/447-4700

Tandy Corp.

1800 One Tandy Center
Fort Worth, TX 76102
817/390-3011

Toshiba America Information Systems, Inc.

Electronic Imaging Division
9740 Irvine Blvd.
Irvine, CA 92718
714/583-3000,
714/583-3522 (fax)

Unisys

P.O. Box 500
Blue Bell, PA 19424
215/986-4011

MANAGE the unmanageable

As an executive consultant with Data Systems Inc., Alexandria, Virginia, Jack Anderson was used to pressure, but this time he was really in trouble . . .



"InstaPlan has unparalleled ease of use and sophistication"

The client needed a proposal for updating its outmoded floppy based PC wordprocessing system. These studies normally take weeks or even months to complete. Interviews, document reviews, procedures analysis, communications studies and many other factors must all be taken into account. To make matters worse, not only did the client need it in a week, but the client was a friend, whose new job depended on Jack delivering the goods by Friday. Understandably, Jack was nervous.

With no room for error, Jack turned to the world wide leaders in full service project management, Micro Planning International. In addition to consulting and training services, MPI provides powerful but easy to use software for DOS, Windows and Macintosh computers, Jack chose InstaPlan (IP) and was up and running in minutes. He found its outline approach let him start with his broad objectives, working down into more detail as needed.

To hit this deadline, Jack was going to have to leverage client resources. InstaPlan's superb graphical reports (Gantt, PERT, and Resource Spreadsheet) allowed Jack to communicate quickly and effectively what was needed, when and by whom.

By Friday, the proposal was ready and accepted as the framework for the client's automation program. In Jack's own words, "I couldn't have done it without InstaPlan. It's unparalleled in ease of use and sophistication."

Full Service Project Management from



Micro Planning International
655 Redwood Highway, Suite 311
Mill Valley, CA 94941
(415) 389-1414

San Francisco • Boston • Los Angeles
Bristol • Washington D.C. • Sydney

Announcing InstaPlan 3.0!

The informed choice for Project Management
and Proposals just got better

Easiest to Use:

InstaPlan's easy outline approach works the way you think. Start with the broad objective and work down to the details as necessary. Proposals and plans can be laid out by novices in minutes.

"Learning to set up and edit a project is easier with InstaPlan than any other program"

**Software
Digest**

Full featured:

With InstaPlan's full range of features, Why pay more?

#1 Ease of Use

#1 Ease of Installation

#1 Overall value

CORPORATE
PC WEEK
SATISFACTION POLL

	InstaPlan	Time Line
Outline Approach	✓	✓
Resource Driven Scheduling	✓	✓
Multi-Project Analysis	✓	✓
Progress Tracking	✓	✓
What if (Undo/Redo)	✓	✓
Presentation Graphics		
- Gantt Charts	✓	✓
- PERT Charts	✓	✓
- Resources Histograms	✓	✓
- C/SSR Costing Charts	✓	No
Multiple Resource Calendars	✓	No
Plotter support*	✓	✓
WBS Codes*	✓	✓
File Locking on Networks*	✓	✓
Suggested Retail Price	\$249	\$695
EMS Version SR Price	\$549	\$695

* New in Version 3.0

PERSONAL
COMPUTER
EDITOR'S
CHOICE

INFO
WORLD
EXCELLENT
VALUE

PCWORLD
BEST BUY

PC
MAGAZINE
EDITORS'
CHOICE

Best Buy:

At \$249, InstaPlan is a fraction of the cost of equivalent project management software with comparable features. The EMS Version at \$549 is even better value for those with large projects (10,000+ tasks) or many independent projects to manage.

Special offer! Upgrade from Time Line® or Harvard™ PM for only \$79. Call for details!

InstaPlan (800) 852-7526
30 day money back guarantee.

- Send InstaPlan 3.0 \$249
 Send InstaPlan EMS \$549
 5 1/4" disk
 3 1/2" disk

Send info on:

- Version for Windows
 Consulting/Training

Recommended Configuration: IBM PC/XT/A T/PS 2 & Compatibles
 640K RAM Hard Disk. Printers Supported: IBM ProPrinter &
 Graphics Printer, Epson FX/MX/RX/LQ, Okidata Plug'n Play 192/
 3, 292/3, Toshiba 351, HP LaserJet+/Series II/III/III DeskJet,
 ThinkJet, QuietJet. Plotters Supported: Hewlett Packard & Com-

VISA/MC/AMEX/Checks
 Add \$10 S & H: \$10 Canada: \$60 International:
 CA/FL residents add 6% Sales Tax.

PCW 8/91

Card # _____ Expires: _____

Signature: _____

Name: _____

Company: _____

Address: _____ Phone: _____

City: _____ State: _____ Zip: _____

Introducing the DBMS runs like a mainframe.



Admit it .

Don't you get just a twinge of envy when you see a Mac user having fun while getting the job done?

You're not alone.

Millions of users who needed the power of the PC but wanted the ease-of-use of a Graphic User Interface (GUI) just splurged on Windows and the expensive hardware needed to get the most out of it.

But you don't have to do that.

Because now there's FoxPro®2.0.

Why should the rich have all the fun.

FoxPro 2.0 gives you the ease-of-use of a Graphic User Interface on your character-based DOS PC.

Use pull-down menus to open multiple windows (in DOS) and see all the data you need to see at once. Build easy-to-use screens for entering and viewing data just by picking-and-clicking to place menus, buttons, checkboxes and scrolling lists anywhere you want them. Create sophisticated, elegant reports without the usual pain. Then assemble

that acts like a Mac and In DOS.

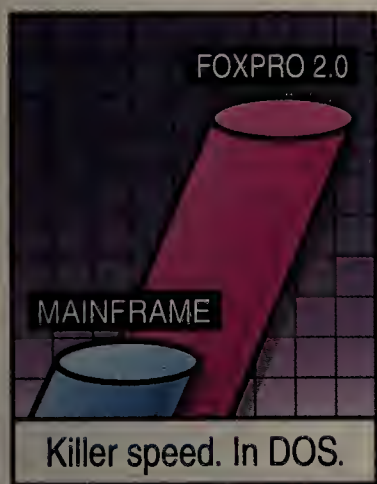

everything into your own custom applications.

Without writing a single line of programming code.

But that's only the tip of the iceberg.

Beneath its Mac-like interface, FoxPro delivers all the power and

technology needed for your database management systems in the 1990s.

Our new memory management techniques let you work with the memory you have now while speeding up your applications.

Our new compound indexes are less than a quarter the size of those in competitive products and far, far faster.

Our new Relational Query-By-Example (RQBE) is a simpler, interactive interface to the information you need.

Our new Rushmore™ query optimization† accesses that information two orders of magnitude or more faster‡ than ever before.

You'll like being able to seamlessly use the SQL SELECTs that RQBE creates in any of your applications. (And the new UPDATE, INSERT and CREATE TABLE commands, too.)

And you'll love the fact that to the rich development environment we've always had, we've added a project manager that keeps track of all the needed files and any changes, then automatically builds your application or .EXE files. An API that lets you dynamically link to libraries you write in C or assembler with a single FoxPro command. A BROWSE

FOR that's the basis for an entire application itself.

Fourth Generation Language (4GL) tools that make adding event-driven code to fully relational screens, menus, reports and labels a snap.

And we've made our networking even better than when NSTL said:* "... multiuser databases fall into two general performance categories: FoxPro/LAN and all the others ..."

There isn't a DBMS in existence with the power of FoxPro.

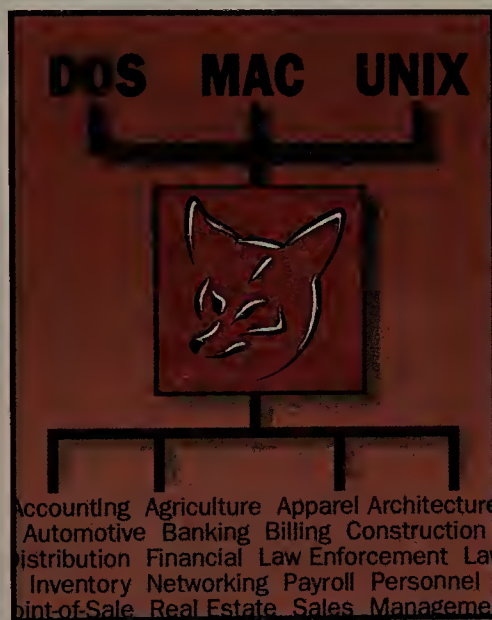

The bigger your business, the bigger your investment.

So we've maintained downward compatibility with your existing systems, and you can use FoxPro 2.0 to run your current dBASE (and Fox) applications on your present character-based DOS PCs.

While you develop better, faster database management systems using all the advanced power of FoxPro 2.0 to satisfy your future information processing needs.

To get the most out of your investments, call and ask about our Upgrade-Any-DBMS-for-\$195 offer.

Call now for your FREE demo disk.

FoxPro 2.0 runs on a 512K XT yet in extended mode uses every bit of power in a 386 or 486. To try it yourself, call Fox Software for a free copy of our fully-featured demo or the name of your nearest dealer.

You'll be amazed at what FoxPro 2.0 can do for you. In DOS.

Call 1-800-837-FOX2 or 419-874-0162 today.
(Ask for Offer PCD-801)

FoxPro 2.0

The complete power trip.™

† Patent applied for. ‡ A PC and FoxPro beat a mainframe and DB2 with a million-record, 200 megabyte database! * Quote from Software Digest Ratings Report, Vol. 7, Issue 13 (Oct. 1990) refers to FoxPro 1.02. Software Digest is a registered trademark of NSTL, Inc. Upgrade price valid only in U.S.A. and Canada. FoxPro TM Fox Holdings Inc. © Fox Holdings Inc. 1991.

286 SYSTEMS



The good old 12-MHz 286 PC is still a bargain, especially for work-at-home users—and 16-MHz units make surprisingly fast Windows machines. Here's how to choose the best from 73 models.



MARCIA STEIGER

CATHY SMITH, MICHAEL GOODWIN, AND TJ BYERS



Need an inexpensive PC for your home office? Or a LAN workstation to run multiuser software from a server? A 286 will get your work done at a price that's hard to resist. These nonsense machines come in several varieties, with clock speeds from 8 to 20 MHz. The models listed here, 12 MHz and 16 MHz, average about the same price: \$2200 for a fully equipped configuration. However, a 12-MHz machine may cost a few hundred less than a 16-MHz unit from the same manufacturer.

Even a 12-MHz 286 is sufficient for tasks like word processing, where speed isn't critical. And the 16-MHz speedsters deliver unexpectedly strong performance with *Windows* (see the sidebar "286—Windows Spoken Here").

We've divided this Buyers' Guide of 73 286 systems into two sections based on CPU speed. Although the 16-MHz chip runs as reliably as the 12-MHz version, major vendors seem to prefer the 12, so if company size and stability are more important to you than performance, a 12-MHz system from one of those companies may be a better choice.

Here are the key issues that you need to consider before you buy.

LIST PRICE

Prices are based on a configuration designed to run *Windows* or RAM-hungry DOS applications like 1-2-3: 4MB of RAM, an 80MB to 120MB hard disk, a floppy drive, one parallel and one serial port, a VGA color graphics card, a VGA color monitor, a 101-key keyboard, a mouse, and DOS 3.3 or a later version. When you buy through a dealer, expect a discount of 20 to 30 percent off list price.

CPU SPEED

The speed of your applications depends on many factors, including your hard disk and video board, but, all else being equal, the faster the CPU the faster the PC.

FAST RAM

Eventually, most users will want to install at least 4MB of *fast RAM* (memory that runs at the same speed as the CPU). Many of today's high-powered DOS applications—not to mention *Windows*—use a lot of RAM. You can always add RAM by placing it on an

expansion board, but this degrades performance.

EXPANDABILITY

Most 286 PCs boast a small, 16-by-16-inch footprint that's just right for crowded desktops, but the compact size means fewer expansion slots and drive bays. If you're going to network your 286 and share the server's hard disk and peripherals, this may not be a problem. But for stand-alone computing, make sure you get at least four free 8/16-bit slots (after the disk controller and video card are installed) to accommodate peripherals like scanners, fax-modems, and network boards. For stand-alone computing you'll also want at least four drive bays, with three externally accessible to hold two floppy drives and a tape drive. And unless you're definitely going the workstation route, don't buy anything smaller than an 80MB hard disk—you will find 40MB drives are not significantly cheaper.

DESIGN AND CONSTRUCTION

Conveniences like front-panel power and reset switches are nice, and with a switchless set-

up you can make changes—in memory size, for instance—without fiddling with jumpers or DIP switches. Since preferences in keyboard touch vary, type a few paragraphs before you buy.

WARRANTY AND TECHNICAL SUPPORT

All the vendors listed provide at least a 12-month warranty, but 24 months is even better—as long as it doesn't cost extra. Free on-site service and a central tech support line can be godsend, especially if you're at home or in an office with no support technicians. If the vendor handles service and support via local dealers, look for dealer training so your questions will be answered correctly.

The 286 may be aging technology, but it can still do the job and do it economically. Whether you're in the market for a 12-MHz workhorse or a 16-MHz thoroughbred, if you choose the right 286 you'll enjoy years of useful service. ☺

Cathy Smith is an editorial assistant, Michael Goodwin an associate editor, and TJ Byers a contributing editor for PC World.

12-MHz 286 COMPUTERS

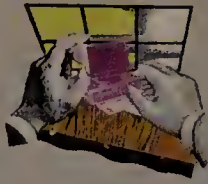

STANDARD FEATURES

Manufacturer	Model	Price ¹	CPU speed (MHz)	Fast-RAM capacity (MB)	8/16-bit slots	8-bit slots	Max. number of third-/half-/full-height drives	Externally accessible bays	Largest hard disk sold with machine	Parallel ports	Serial ports	Dedicated mouse port
ACER	915P(II)	\$1249	12	5	2	0	0/4/0	1	100MB	1	2	Y
	AcerStation II	\$1195	12	5	2	0	0/2/0	1	100MB	1	2	N
ADVANCED LOGIC RESEARCH	PowerFlex 40	\$1295	12.5	5	1	0	2/2/0	4	100MB	1	1	N
	PowerFlex 286	\$2843	12.5	5	5	1	2/2/0	3	80MB	1	1	N
AEG OLYMPIA	D286/12	\$3345	12.5	4	5	3	0/5/0	3	200MB	1	2	N
ARCHE TECHNOLOGIES	Triumph 286 Plus	\$3265	12	4	3	2	0/2/2	4	338MB	1	2	Y
BLACKSHIP COMPUTER SYSTEMS	BLK286/12	\$1395	12	4	6	2	2/4/0	3	200MB	1	2	N
BOSS TECHNOLOGY	Tomcat 286/12	\$2695	12	5	3	2	1/2/0	2	200MB	1	2	N
DATAWORLD	Dato 286-12	\$2205	8/12 ⁴	4	4	2	0/5/0	3	676MB	1	2	N
DELL COMPUTER	Dell System 210	\$2678	12.5	6	3	0	2/1/2	2	100MB	1	2	N
DFI	DFI 286/12	\$1495	12	4	5	3	4/3/0	3	340MB	1	2	N
ELTECH RESEARCH	1120S	\$1779	12	8	6	2	1/3/0	3	200MB	1	2	N
EPSON AMERICA	Equity 286 Plus	\$4120	12	5	3	1	1/3/0	2	200MB	1	1	Y
EPS TECHNOLOGIES	EPS 80286-12	\$1795	12	8	6	2	0/5/0	3	200MB	1	2	Y
ESC COMPUTERS	ESC286-12Z	\$1450	12	4	5	3	0/5/0	3	1.2GB	1	2	N
EVEREX	Tempo 286/12	\$2040	12	4	6	2	0/3/0	2	200MB	1	2	N
	Tempo 286/12c	\$1999	12	4	4	0	2/1/0	2	200MB	1	2	N
FASTMICRO	FastDato 286/12	\$1679	12	8	6	2	7/3/3	3	200MB	1	2	N
FLYTECH TECHNOLOGY	FT 9200 Series	\$1559	12	1	0	1	0/2/0	1	80MB	1	2	N
FORTRON	Fortron 286-12	\$1750	12	4	5	1	2/2/1	3	200MB	1	2	N
HIQUALITY	HiQ 286/12	\$1295	12/16 ⁴	8	6	2	0/2/3	0	100MB	1	2	Y
JADE COMPUTER	ProTurbo 286	\$1648	12	8	4	1	0/3/0	0	383MB	1	2	Y
LEADING SPECT	Leading Spect	\$1495	12	4	6	2	0/5/0	0	120MB	1	2	N
METRA INFORMATION SYSTEMS	M-212	\$1445	12	4	5	2	0/4/0	3	200MB	1	2	N
NCR	PC286	\$3085	12	5	2	0	0/2/0	1	120MB	1	2	N
NEC TECHNOLOGIES	PowerMate 286/12	\$4496	12	5	4	0	0/3/0	2	140MB	1	1	Y
THE NETWORK CONNECTION	Triumph 2000/12-4	\$1995	12	4	6	2	0/3/0	3	200MB	1	2	N
POLYWELL COMPUTERS	Poly 286-12Fox	\$1398	12	4	4	2	2/3/0	5	200MB	2	2	N
PROTEUS TECHNOLOGY	286 GTX	\$1385	12	4	6	2	2/3/0	4	230MB	1	2	Y
SUN MOON STAR	System 286-12	\$2339	12	4	3	0	0/4/0	3	200MB	1	2	N
SUNNYTECH	STI 286-12	\$1295	12	16	8	0	1/3/0	3	210MB	1	2	N
SUPER COMPUTER	Super IAT 12Mhz	\$1495	12	4	6	2	0/5/0	3	200MB	1	2	N
TATUNG	TCS-7450	\$1595	12	5	3	0	2/1/0	2	200MB	1	2	Y
	TCS-7120	\$1650	12	4	3	1	3/0/0	2	200MB	1	2	Y
TELEVIDEO	286se	\$2625	12.5	1	3	0	0/1/0	1	200MB	1	2	N
	286e	\$3220	12.5	4	5	1	0/3/1	3	200MB	1	2	N
TWINHEAD	SuperSet 400II/12V	\$2138	12	5	4	0	2/4/0	3	200MB	1	2	N
	Netstation 12V	\$2129	12	5	2	0	2/0/0	1	200MB	1	2	N
ULTRA COMP	Ultra 286-12	\$2115	8/12 ⁴	4	5	3	0/5/0	3	200MB	1	2	N
UNISYS	PW 300/12	\$4989	12	8	3	1	0/2/0	1	170MB	1	1	N

¹ Price based on 4MB RAM, 1.2MB or 1.44MB floppy drive, 80MB to 120MB hard disk, one parallel and one serial port, VGA controller and color monitor, 101-key keyboard, mouse, and DOS 3.3 or later version.

² Extra-cost option.

³ Vendor does not sell through dealers.

⁴ Switchable setting.

WHERE TO BUY

Acer
401 Charcot Ave.
San Jose, CA 95131
408/922-0333,
408/922-0175 (fax)

Advanced Logic Research
9401 Jeronimo
Irvine, CA 92714

800/444-4257,
714/581-9240 (fax)

AEG Olympia
3140 Rt. 22W, Box 22
Somerville, NJ
08876-0022
908/231-8172,
908/231-8457

Arche Technologies
48881 Kato Rd.
Fremont, CA 94539
800/422-4674,
415/623-8171 (fax)

AST Research Inc.
16215 Alton Pkwy.
P.O. Box 19658
Irvine, CA

92713-9658
800/876-4278,
714/727-9355 (fax)

Austin Computer
10300 Metric Blvd.
Austin, TX 78758
800/752-1577,
512/454-1357 (fax)

Blackship Computer Systems, Inc.
4031 Clipper Ct.
Fremont, CA 94538
800/877-6249,
415/770-8674 (fax)

Boss Technology
6050 McDonough Dr.
Norcross, GA 30093

DESIGN

SERVICE AND SUPPORT

Built-in floppy controller	Built-in VGA controller	Intel 80287 support	Switchless setup	Tilt-and-swivel monitor	Front-panel on/off	Front-panel reset	Compact footprint (16 by 16 inches)	Warranty (months)	Free on-site service (months)	Toll-free technical support	Doily support (hours)	Weekend support	Technical support BBS/fox	Vendor requires dealer training	Reorder service number
Y	N	N	Y	Y ²	Y	Y	Y	24	0	N	11	N	Y/Y	Y	710
Y	Y	N	Y	Y ²	Y	Y	Y	24	0	Y	11	N	Y/Y	Y	710
Y	N	N	Y ²	Y	N	N	Y	12	0	N	9	N	Y/Y	Y	711
Y	N	Y	Y	Y	Y	N	N	12	9	N	9	N	Y/Y	N	711
Y	Y	Y	Y	Y	Y	Y	Y	12	0	N	9	N	N/Y	N	712
Y	N	Y	Y	Y ²	N	Y	Y	24	24	Y	10	N	Y/N	Y	713
Y	Y	Y	Y	Y	N	Y	Y	12	12	Y	9	N	N/Y	3	714
Y	Y	Y	Y	Y	Y	Y	Y	12	12	Y	9	N	N/Y	N	715
Y	N	Y	N	Y	N	N	Y ²	12	12	Y	11	Y	N/Y	N	716
Y	Y	Y	Y	Y	Y	N	Y	12	12	Y	15	Y	Y/Y	3	717
N	N	Y	Y	Y	Y	Y	Y	12	12	N	9.5	N	N/Y	3	718
N	N	Y	N	Y	Y	Y	Y	12	12	Y	9.5	N	N/Y	N	719
Y	Y	Y	Y	Y	Y	Y	N	12	0	N	9	N	Y/N	Y	720
Y	Y	Y	Y	Y	N	N	N	12	12	Y	11	Y	Y/Y	N	721
N	N	Y	Y	Y	Y	Y	Y	12	0	Y	8	N	N/N	N	722
N	N	Y	Y	N	N	Y	Y	12	3	N	11	N	Y/Y	Y	723
Y	N	Y	Y	N	Y	N	Y	12	3	N	11	N	Y/Y	Y	723
N	N	N	N	Y	Y	Y	Y	12	12	Y	8	Y	N/Y	3	724
Y	Y	Y	Y	Y	Y	Y	Y	12	0	N	9	N	N/Y	N	725
N	N	Y	Y	Y	N	N	N	12	12	Y	9.5	N	N/Y	3	726
Y	Y	N	Y	Y	Y	Y	Y	12	0	Y	11	Y	Y/Y	N	727
Y	Y	Y	Y	Y	Y	Y	Y	12	0	Y	8	N	N/Y	N	728
Y	Y	Y	Y	Y	Y	Y	Y	12	0	N	8	Y	N/Y	N	729
Y	Y	Y	Y	Y	Y	Y	Y	12	0	Y	9.5	Y	N/Y	N	730
Y	Y	Y	Y	Y	Y	N	Y	12	12	N	5	5	5	Y	731
Y	Y	Y	Y	Y ²	Y	Y	Y	12	0	Y	11.5	N	N/N	Y	732
Y	Y	Y	Y	Y	Y	Y	Y	12	0	Y	10	Y	Y/Y	3	733
N	N	Y	Y	Y	Y	Y	Y	12/60 ⁶	12	Y	10	Y	Y/N	3	734
Y	Y	Y ²	Y	Y	Y	Y	Y	24	24	Y	24	Y	Y/Y	N	735
Y	N	N	Y	Y	Y	Y	Y	36	12	Y	10	N	N/Y	N	736
N	N	Y	Y	Y	Y	Y	Y	24	0	Y	8	Y	N/Y	3	737
Y	Y	N	Y	Y	N	N	N	12	0	N	6	N	N/Y	N	738
Y	Y	Y	Y	Y	N	Y	Y	12	4	Y	10	N	Y/Y	Y	739
Y	N	Y	Y	Y	N	Y	Y	12	4	Y	10	N	Y/Y	Y	739
Y	Y	Y	Y	Y	N	Y	Y	12	0	N	9	N	N/Y	N	740
Y	Y	Y	Y	Y	N	Y	Y	12	0	N	9	N	N/Y	N	740
Y	Y	Y	Y	Y	Y	Y	Y	12	12	Y	12	N	Y/Y	N	741
Y	Y	Y	Y	Y	Y	Y	Y	12	12	Y	12	N	Y/Y	N	741
N	N	Y	N	Y	N	Y	Y	12	12	Y	9	N	N/N	3	742
Y	N	Y	Y	Y	Y	Y	Y	12	0	Y	24	Y	Y/Y	Y	743

For more information about all products in this table, circle reader service no. 907.

⁵Varies from dealer to dealer.
⁶12 months parts/60 months labor.

800/628-1787,
404/368-2077

CSS Laboratories
1641 McGaw Ave.
Irvine, CA 92714
800/966-2771,
714/852-0410 (fax)

C2
47448 Fremont Blvd.
Fremont, CA 94538
415/683-8888,
415/683-8893 (fax)

DataWorld
3733 San Gabriel
River Pkwy.
Pico Rivera, CA

90660-1495
800/736-8080,
213/695-3777

Dell Computer Corp.
9505 Arboretum Blvd.
Austin, TX
78759-7299

800/426-5150,
512/338-8700 (fax)

DFI
2544 Port St.
West Sacramento, CA
95691
916/373-1234,
916/373-0221 (fax)

Eltech Research Corp.
47266 Benicia St.
Fremont, CA 94538
800/234-4331,
415/438-0663
(continues)

16-MHz 286 COMPUTERS



STANDARD FEATURES

Manufacturer	Model	Price ¹	CPU speed (MHz)	Fast-RAM capacity (MB)	8/16-bit slots	8-bit slots	Max. number of third-/half-/full-height drives	Externally accessible bays	Largest hard disk sold with machine	Parallel ports	Serial ports	Dedicated mouse port
ACER	915V(II)	\$1499	16	5	4	0	0/4/0	2	100MB	1	2	Y
AST RESEARCH	Bravo 286/16	\$2489	16	16	5	0	0/4/0	2	40MB	1	2	Y
AUSTIN COMPUTER	Austin 286/16	\$2165	8/16 ³	8	6	1	0/4/0	3	330MB	2	3	N
BLACKSHIP COMPUTER	BLK286/16	\$1495	16	4	6	2	2/4/0	3	200MB	1	2	N
CSS LABORATORIES	Preferred 286-16	\$1736	16	2	7	1	0/2/2	3	1.2GB	1	2	N
C2	Warrior 16/S	\$1900	16	5	5	1	1/1/1	3	200MB	1	2	N
DFI	DFI 286/16	\$2049	16	4	5	3	4/3/0	3	340MB	1	2	N
ELTECH RESEARCH	1100S	\$1899	16	8	6	2	1/3/0	3	200MB	1	2	N
EVEREX	Tempo 286/16	\$2099	16	4	6	2	0/3/0	2	200MB	1	2	N
	Step 286/16	\$2842	16	4	6	2	0/3/0	2	200MB	1	2	N
FLYTECH TECHNOLOGY	FT 9250 Series	\$2379	16	4	0	1	0/2/0	1	80MB	1	2	N
GATEWAY 2000	286-16 MHZ	\$1495	16	16	5	0	0/3/0	2	200MB	1	2	Y
INSIGHT	Insight 286	\$1595	16	4	6	2	1/4/0	5	340MB	2	2	N
MAGITRONIC TECHNOLOGY	M-216-40	\$1695	16	4	5	2	0/3/1	4	130MB	1	2	N
MICRO EXPRESS	ME 286/16	\$1499	16	8	6	2	2/3/0	4	700MB	1	2	N
MICRO SMART	Smart Micro 286 Plus	\$1830	16	16	6	2	0/0/4	3	1.2GB	1	2	N
MITSUBA	Mitsuba 286-16	\$2195	16	5	5	3	0/4/0	3	210MB	1	2	N
MULTIMICRO	MMI 286-16	\$1992	16	4	6	2	1/3/0	1	1.2GB	1	2	N
OLIVETTI OFFICE USA	M290S	\$4159	16	5	3	0	2/1/0	2	100MB	1	1	Y
OSICOM	Executive SL 286/16	\$2699	16	4	5	0	0/3/0	2	210MB	1	2	Y
PC AMERICA	GEM 286t	\$2177	16	4	5	2	0/5/0	3	1.2GB	1	2	N
PC BRAND	286/16 ISA	\$1996	16	8	6	1	0/6/0	4	660MB	1	2	N
PC HOUSE	Data 80	\$1240	16	5	6	2	3/1/0	1	180MB	1	2	N
POLYWELL COMPUTERS	Poly 286-16S	\$1500	16	8	5	2	2/3/0	5	200MB	2	2	N
REPLY	286/16	\$4890	16	8	5	0	2/2/1	3	400MB	2	2	Y
SWAN TECHNOLOGIES	286/16	\$2119	16	8	6	1	0/4/0	3	200MB	2	1	N
SYSTEK	System-286/16	\$1495	16	4	6	2	3/9/8	4	667MB	1	2	Y
TANDY	2500 XL/2	\$3447	16	4	3	0	0/2/1	3	440MB	1	2	Y
TENEX	Tenex 286/16	\$1779	16	5	2	3	0/3/0	2	200MB	1	2	N
UNITEK MICROSYSTEMS	Plamar 216	\$1611	16	8	3	0	2/3/1	4	320MB	1	2	N
US INTEGRATED TECHNOLOGIES	Athena 286/16	\$2749	16	4	3	0	0/3/0	2	200MB	1	2	Y
WANG	PC 250/16	\$4490	16	8	4	1	0/3/0	2	100MB	1	2	N
WLT	AT216-6	\$2316	16	8	5	1	0/4/0	2	100MB	1	2	N

¹ Price based on 4MB RAM, 1.2MB or 1.44MB floppy drive, 80MB to 120MB hard disk, one parallel and one serial port, VGA controller and color monitor, 101-key keyboard, mouse, and DOS 3.3 or later version.

² Extra-cost option.

³ Switchable setting.

⁴ Vendor does not sell through dealers.

⁵ 12 months parts/60 months labor.

WHERE TO BUY

(continued)

Epson America
20770 Madrona Ave.
Torrance, CA 90503
213/782-0770

EPS Technologies, Inc.
10069 Dakota St.
Jefferson, SD 57038
800/447-0921,
605/966-5482 (fax)

ESC Computers, Inc.
7042 Owensmouth Ave.
Canoga Park, CA 91303
818/888-0188,
818/888-7090 (fax)

Everex
48431 Milmont Dr.
Fremont, CA 94538
415/498-1111,
415/683-2400 (fax)

FastMicro
3655 E. La Salle St.
Phoenix, AZ 85040
800/441-3278

Flytech Technology
3008 Scott Blvd.
Santa Clara, CA 95054
408/727-7373,
408/727-7375 (fax)

Fortron
6818-G Patterson Pass Rd.
Livermore, CA 94550
415/373-1008,
415/373-1168 (fax)

Gateway 2000
610 Gateway Dr.
North Sioux City, SD 57049
800/523-2000,
605/232-2023 (fax)

HiQuality
740 N. Mary Ave.
Sunnyvale, CA 94086
408/245-5836,
408/245-3108

Insight
1912 W. Fourth St.
Tempe, AZ 85281
800/776-7600,
602/829-9193 (fax)

DESIGN

SERVICE AND SUPPORT

Built-in floppy controller	Built-in VGA controller	Intel 80287 support	Switchless setup	Tilt-and-swivel monitor	Front-panel on/aff	Front-panel reset	Compact footprint (16 by 16 inches)	Warranty (months)	Free on-site service (months)	Toll-free technical support	Daily support (hours)	Weekend support	Technical support BBS/fax	Vendor requires dealer training	Reader service number
Y	Y	N	Y	Y ²	Y	Y	Y	24	0	N	11	N	Y/Y	Y	675
Y	Y	Y	Y	Y	Y	Y	Y	12	0	Y	10	N	Y/Y	Y	676
Y	N	Y	N	Y	N	N	Y	12	12	Y	15	Y	Y/N	4	677
Y	Y	Y	Y	Y	N	Y	Y	12	12	Y	9	N	N/Y	4	678
Y ²	N	Y	N	N	N	Y	N	18	12	Y	13	N	Y/Y	N	679
Y	N	Y	Y	Y	Y	Y	Y	12	12	Y	9	N	N/Y	N	680
N	N	Y	Y	Y	Y	Y	Y	12	12	N	9.5	N	Y/N	N	681
N	N	Y	N	Y	Y	Y	Y	12	12	Y	10.5	N	N/Y	N	682
N	N	Y	Y	N	N	Y	Y	12	3	N	11	N	Y/Y	N	683
N	N	Y	Y	N	N	Y	Y	12	12	N	11	N	Y/Y	N	683
Y	Y	Y	Y	Y	Y	Y	Y	12	0	N	9	N	N/Y	N	684
Y	Y	N	Y	Y	Y	Y	Y	12	12	Y	18	Y	Y/Y	4	685
N	N	N	Y	Y	N	Y	Y	12	0	Y	12	Y	N/Y	N	687
Y	Y	N	N	Y ²	Y	Y	Y	12	0	Y	9	N	Y/Y	N	688
Y	Y	N	N	Y	Y	Y	Y	12	0	Y	11	N	N/Y	N	689
N	N	Y	Y	Y	Y	Y	Y	12	12	Y	9.5	Y	N/Y	N	690
Y	Y	N	N	Y	N	Y	Y	12	12	Y	9	N	N/Y	N	691
N	N	Y	Y	Y	N	Y	Y	12	12	N	9	N	Y/Y	N	692
Y	Y	Y	Y	Y	Y	N	Y	12	12	Y	8	N	N/Y	N	693
Y	N	N	N	Y	Y	Y	Y	12	12	Y	12	N	Y/Y	N	694
N	N	Y	Y	Y	Y	Y	Y	12	0	N	10	Y	Y/Y	N	695
Y	N	Y	Y	Y	Y	Y	Y ²	60	0	Y	11	N	Y/Y	4	696
Y	Y	N	Y	Y	Y	Y	Y	12	0	N	8.5	Y	N/Y	N	697
Y	N	Y	Y	Y	Y	Y	Y	12/60 ⁵	12	Y	10	Y	Y/Y	N	698
Y	Y	Y	Y	Y	Y	Y	Y	12	12	Y	11.5	N	Y/Y	4	699
Y	Y	Y	Y	Y	N	Y	N	24	24	Y	12	Y	Y/Y	4	700
N	N	Y	Y	Y	Y	Y	Y	12	12	Y	9	Y	N/Y	N	701
Y	Y	Y	Y	N	Y	Y	Y	12	0	N	9	N	Y/N	N	702
Y	Y	N	Y	N	Y	Y	Y	12	0	N	9	N	N/Y	N	703
Y	N	Y	Y	Y	Y	Y	Y	12	0	Y	9	N	N/N	N	704
Y	Y	Y	Y	Y	Y	Y	Y	12	0	N	10.5	N	Y/Y	N	705
Y	Y	Y	Y	Y	Y	Y	N	12	0	Y	19	N	Y/Y	4	706
Y	Y	Y	Y	Y	Y	Y	N	36	36	Y	12	N	N/Y	4	707

For more information about all products in this table, circle reader service no. 906.

Jade Computer

4901 W. Rosecrans
Hawthorne, CA 90251
800/421-5500,
213/675-2522 (fax)

Leading Spect

1049 Segovia Cir.
Placentia, CA 92670
800/234-0688,
714/666-2626

Magitronic Technology

10 Hub Dr.
Melville, NY 11747
516/454-8255,
516/454-8258 (fax)

Metra Information Systems

935 Benecia Ave.
Sunnyvale, CA
94086-0897
800/733-9188,
408/730-5933 (fax)

Micro Express

1801 Carnegie Ave.
Santa Ana, CA 92705
800/642-7621,
714/852-1225 (fax)

Micro Smart Inc.

200 Homer Ave.
Ashland, MA 01721
800/370-9090,
508/872-9090,
508/881-1520

Mitsuba Corp.

1925 Wright Ave.

Laverne, CA 91750
800/648-7822,
714/392-2000,
714/392-2021 (fax)

MultiMicro, Inc.

582 Folsom St.
San Francisco, CA
94105
800/848-4256
415/979-0140,
415/979-0142

NCR Corp.

1700 S. Patterson Blvd.

Dayton, OH 45479
513/445-5000,
513/445-2008 (fax)

NEC Technologies, Inc.

1414 Massachusetts Ave.
Boxborough, MA
01719
508/264-8000,
508/264-8673

WHERE TO BUY

(continued)

The Network Connection

1324 Union Hill Rd.
Alpharetta, GA 30201
800/327-4853,
404/751-1884 (fax)

Olivetti Office USA

765 U.S. Hwy. 202
Bridgewater, NJ
08807
908/526-8200,
908/526-8405 (fax)

Osicom

198 Green Pond Rd.
Rockaway, NJ 07866
201/586-2550,
201/586-9740 (fax)

PC America

3624 Pierce Rd.
Bakersfield, CA 93308
805/323-0707,
805/323-9747 (fax)

PC Brand

877 Supreme Dr.
Bensenville, IL 60106
800/722-7263
800/722-7392 (fax)

PC House

841 E. Artesia Blvd.
Carson, CA 90746
213/324-8621,
213/324-8654 (fax)

Polywell Computers

61-C Airport Blvd.
South San Francisco,
CA 94080
800/999-1278,
415/583-7222,
415/583-1974 (fax)

Proteus Technology Corp.

377 Rt. 17 S.
Airport 17 Center
Hasbrouck Heights, NJ
07604

800/878-6427,
201/288-2245

Reply Corp.

4435 Fortran Dr.
San Jose, CA 95134
408/942-4804,
408/942-4897 (fax)

Sun Moon Star

1941 Ringwood Ave.
San Jose, CA 95134
800/545-4786,
408/452-1411 (fax)

Sunnytech, Inc.

17 Smith St.
Englewood, NJ 07631
800/367-1132,
201/569-6279 (fax)

Super Computer, Inc.

17910 S. Adria Maru Ln.
Carson, CA 90746
213/532-2133,
213/532-6342 (fax)

Swan Technologies

3075 Research Dr.
State College, PA
16801
800/468-9044,
814/237-5416

Systemk

5310 W. 161 St.
Brook Park, OH 44142
216/676-6511,
216/676-6521 (fax)

Tandy Corp.

1800 One Tandy Center
Fort Worth, TX 76102
817/390-3011,
817/390-2774 (fax)

Tatung

2850 El Presidio St.
Long Beach, CA
90810
213/979-7055,
213/637-8484 (fax)

TeleVideo

550 E. Brokaw Rd.
San Jose, CA
95161-9048
800/835-3228,
408/954-0623 (fax)

Tenex

56800 Magnetic Dr.

286—WINDOWS SPOKEN HERE

Michael Goodwin

Conventional wisdom holds that while a 286 system is fine for single-task DOS-based applications like word processors, you need a fast 386 for Windows. As a general rule, we agree—but there are exceptions, notably fast 16-MHz 286s, where low price and high performance come together.

PC World Test Center benchmarks show that Windows actually runs a hair faster on a 16-MHz 286 in standard mode than on a 16-MHz 386SX in enhanced mode. Of course, standard mode lacks a few Windows niceties, such as virtual memory and multi-tasking: You can't type a memo in *WordPerfect*, for instance, while *Quattro* is recalculating a worksheet in the background. But if you'll settle for context switching (flipping between applications without having to quit and save first), or if you want to run just one Windows application like *Excel*, a 286 may be your best deal. Of course, most DOS applications run a bit slower on a 286 than on a 386.

Most bargain hunters probably won't care, since these 286s average about \$1500 less than comparable 16-MHz 386SXs.

Windows 3.0

Everex Tempo 286/16	168
Everex Tempo 386SX16*	178

seconds 0 40 80 120 160 200

*386 enhanced mode

Methodology

We tested the computers with 4MB RAM and 80MB hard disks. Timing begins and ends at the DOS prompt. We launch Windows along with a macro that loads *Excel* with a financial worksheet and initiates a recalc. Then the macro loads *Lotus Ami Pro* along with a 50K document that contains a 500K TIFF image. Finally, the macro launches *Micrografx Designer*, opens a drawing, displays it on screen, and exits to DOS.

Data based on tests designed and conducted by the PC World Test Center. All rights reserved.

Mishawaka, IN
46545-7481
800/776-6781,
219/255-1778 (fax)

Twinhead Corp.

1537 Centre Pointe Dr.
Milpitas, CA 95035
800/545-8946,
408/945-1080 (fax)

Ultra Comp

3801 Ultra Comp Dr.
Earth City, MO 63045
800/435-2266,
314/298-1998,
314/298-1288 (fax)

Unisys

P.O. Box 500
Blue Bell, PA 19424
215/986-2214,
215/986-2312 (fax)

Unitek

Microsystems
7101 Adams #1
Willowbrook, IL 60521
800/535-7885,
708/323-3442 (fax)

US Integrated Technologies

3023 Research Dr.
Hilltop Industrial Park

Richmond, CA 94806
800/628-8312,
415/223-2766 (fax)

Wang

1005 Pawtucket Blvd.
Lowell, MA 01851
508/459-5000,
508/967-0401

WLT

1005 Pawtucket Blvd.
Lowell, MA 01854
800/272-9771,
508/937-7507,
508/656-8540 (fax)



Focus on Precision Illustration With New Designer 3.1

New!
3.1 Release
Free Trial Software

See for yourself. New Designer 3.1 turns your PC into a precision illustration tool, running under the Microsoft® Windows™ environment. You'll get more accuracy in technical illustrations, greater performance in graphic designs and higher speed in desktop publishing layouts. It's now easier to turn what you can imagine into an image all can see. Call for your free trial software and feel the high performance yourself.

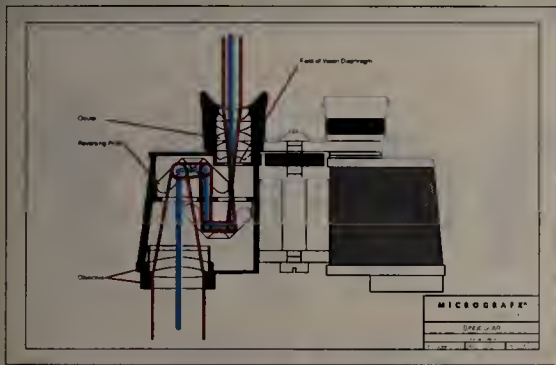

▲ Higher performance in Designer 3.1 speeds up drawings with faster wide styled lines—even wide dashed lines. Object snap points make precision a given.

The view from out front. With new Designer 3.1 you're ahead of the pack no matter how you look at it. With more usable features, higher performance operation and more flexible file handling, you'll be able to create and manipulate an image until it's just right. That's precision.



▲ Choose from 16.4 million colors and save any number of custom palettes for later use. Combine text and graphics with bitmapped images and true layering.

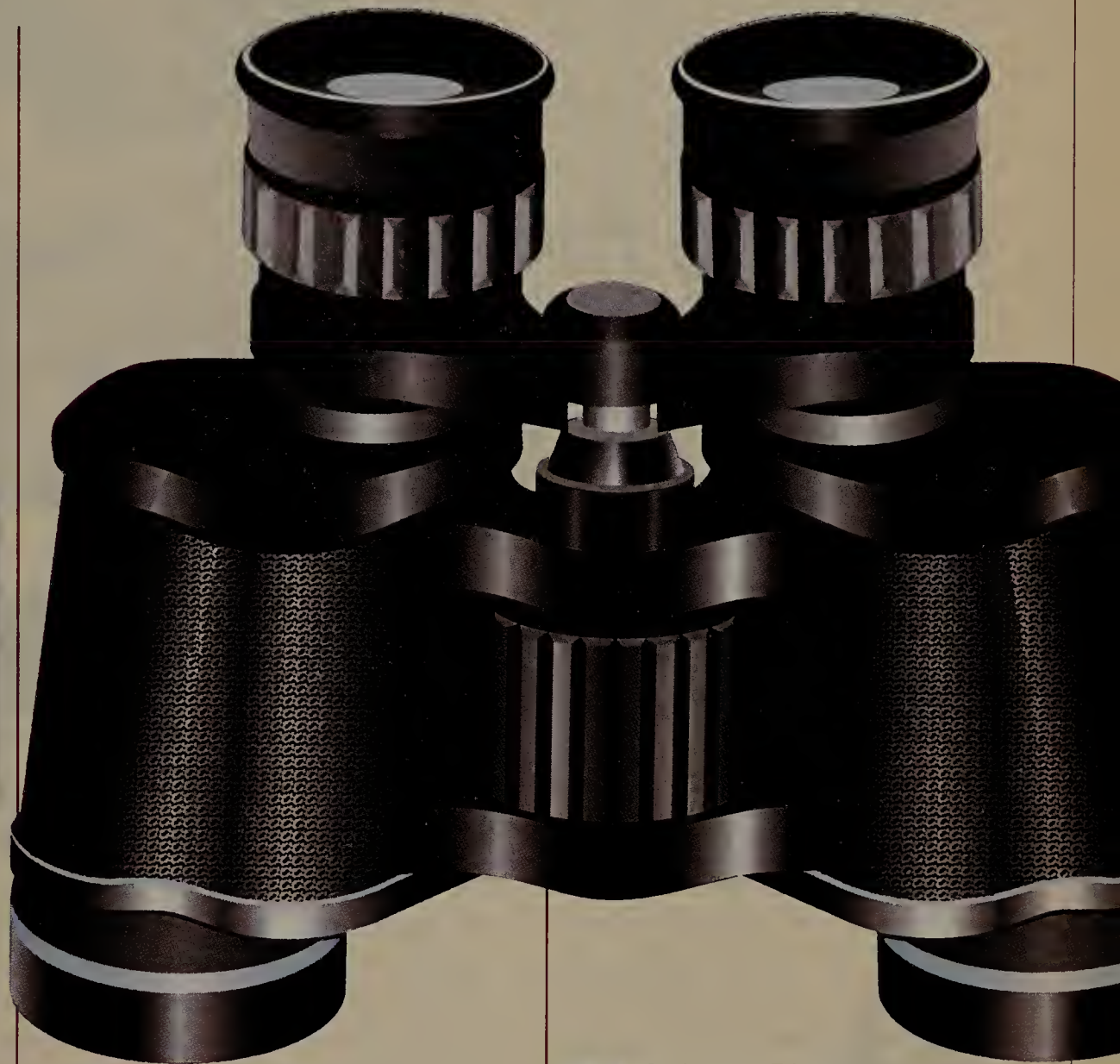

▲ "The power-users choice . . . a customizable toolbox has a tool for just about anything; precise and accurate autotracing utility, CAD-like layering and superb color-publishing capabilities," says PC Magazine.

► Desktop published articles become clearer with precision illustration from Designer 3.1. Multiple file formats speed up import and export of files.

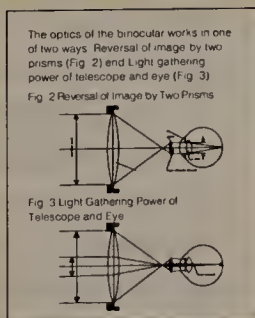

Outside perspective reflects well.

“Designer is an outstanding illustration package that receives Editor’s Choice recognition. Designer is perhaps the most sophisticated of all the illustration packages,” writes PC Magazine.



Software Digest reports that “Designer provides the best overall graphics package. The program offers state-of-the-art features, good performance, and unmatched ease of learning and use in a sophisticated package. Designer can handle virtually any free-form graphics or design task with ease.” Designer was awarded a top-of-the-class rating.

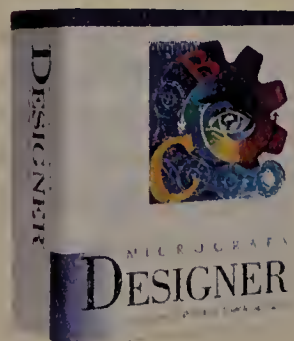

Free hands-on trial. Call now, for a free working model of the new Designer, 800-733-3729, ext. 5050.

On Site: Making the

Clone Commitment

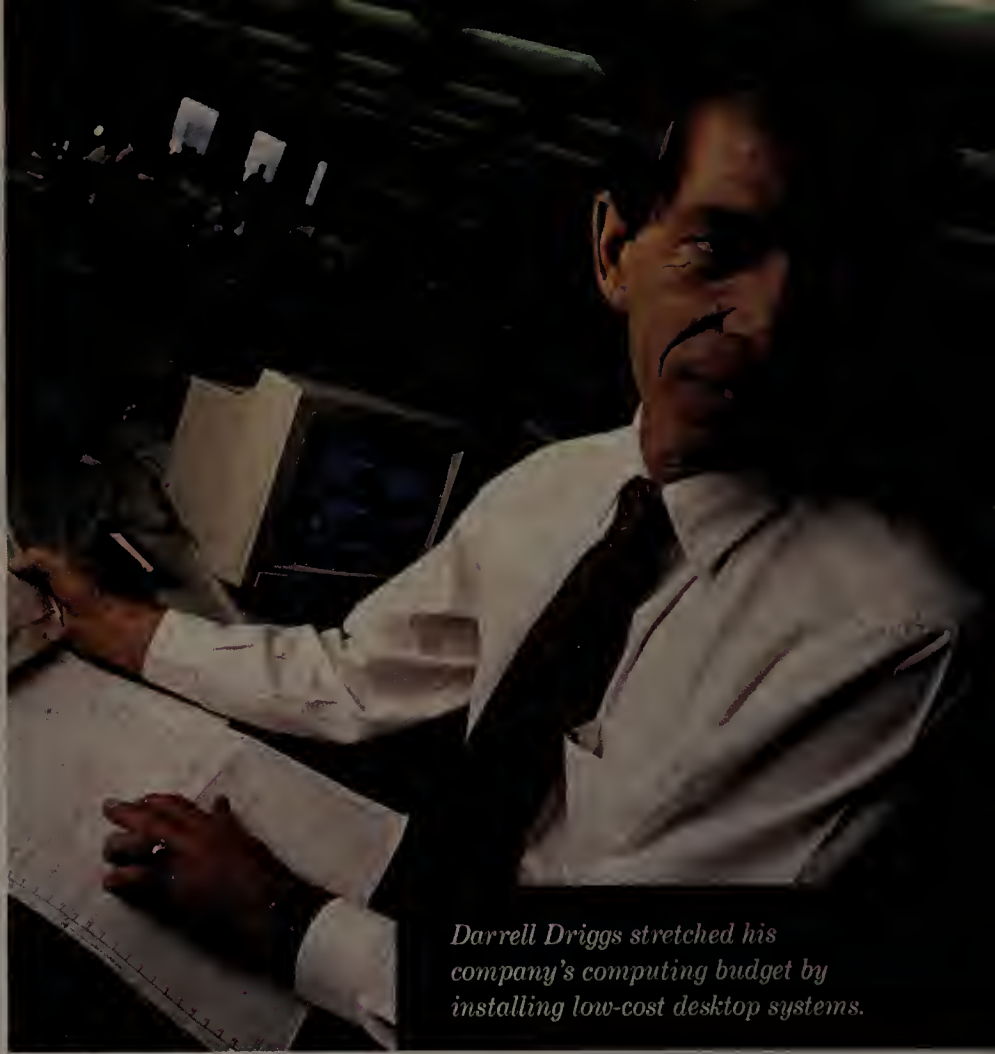

Darrell Driggs stretched his company's computing budget by installing low-cost desktop systems.

Many companies want 386 power but can't afford name-brand prices. Shrewd investment in low-cost technology helped this lumber wholesaler double sales and revolutionize customer service.

A few years ago, Darrell Driggs had a dream: to set up departmental LANs in all 11 divisions of North Pacific Lumber. The problem was, buying 300 brand-name desktop systems all at once was just too expensive. The solution? In a word, clones. Driggs, the company's data processing operations manager, decided to stray from IBM and buy 386-based PC-compatible systems from a local vendor. The decision has paid off in spades, saving the company more than \$123,000—a savings the company invested in completing the installation of 11 interconnected departmental networks. Profits are up, customer turn-around time has been drastically reduced, and employee productivity has more than doubled.

Computers are critical to North Pacific's business for one reason—speed. The atmosphere in the company's Portland, Oregon, trading offices rivals that of Wall Street—frantic traders shouting prices into phones and to each other, buying lumber in all shapes and sizes to resell to customers around the world. “The lumber wholesale business is a competitive one,” explains Phil Myers, vice president of the company's Pole and Piling Division. “The faster you can get an order confirmation out to a customer, the faster you can get to the next customer.”

Before the advent of the LANs, traders wrote quotes by hand, typed order forms, and then rekeyed them into the company's mainframe-based account-

David Rath

ing system—an arduous and repetitive process. They also spent hours looking up rail freight costs and schedules in big, unwieldy rate books.

In 1985, the company's data processing department developed a customized accounting program to run on a small network of 8088-based IBM PCs in a single division. Instead of taking several hours to handle a transaction, a few lucky traders could finalize a deal in a few minutes while the customer was still on the phone. But with a price tag of nearly \$3500 each, the new PS/2 workstations that Driggs wanted were too pricey for North Pacific to purchase en masse for each of its 300 traders. That left most of the company still working the old-fashioned way.

Slow Going

Gradually, Driggs was able to expand the company's PC collection. Because traders need all the desk space they can get, Driggs chose to purchase small IBM PS/2 Model 25s. Although the traders liked the systems' compact size, a problem surfaced: The machines didn't dissipate heat well. "It has been a headache," says Driggs. "The internal heat brings the unit down. Circuit boards have to be replaced." In one year alone, Driggs had to replace 7 out of 23 PS/2s.

In the meantime, the company's business was growing and changing. Traders needed to be able to run the company's custom applications—including accounting, inventory, and freight rate systems—along with off-the-shelf word processing and spreadsheet programs. "When customers call, traders need to be able to jump quickly between, say, the spreadsheets they're working on and an order form," Driggs explains. "The multitasking capabilities of a 386 allow them to do this."

Because of the problems with the PS/2 Model 25s and the desire to upgrade as many workstations as possible to multitasking 386s, Driggs decided to see if he couldn't get reliable products for much less than he'd have to pay IBM—or Compaq, for that matter.

"I felt that the newest 386 generation of clones was much closer in quality to the name-brand PCs than the 286 generation was," he recalls. "Novell had started authorizing many types of clones as nodes on their networks."

Network file servers, Driggs points out, are a different animal than single-user PCs; they require greater reliability and better performance. (North Pacific's older file servers are Compaq Deskpro 286s. Driggs is now buying ALR 25- and 33-MHz 386 machines to act as servers on newer networks.) Although Driggs was willing to take a bigger risk on the workstations to save money, they still had to meet the company's strict standards for compatibility and reliability.

Early attempts to locate a reliable vendor proved disappointing. Of three machines Driggs bought from one East Coast mail-order vendor, only one was configured correctly. "We couldn't get a response from the tech support staff," says Driggs, who has little patience with unresponsive suppliers. Another machine that failed North Pacific's network test was a "home-brew" computer built in the Portland area. Although Driggs describes the machine as "frighteningly cheap" (under \$2000 for a full-bore 386 with VGA graphics), it was incompatible with the company's network standards.

Filling the Bill

After the failed experiments with mail-order and home-brew dealers, Driggs was still looking around. In April 1990, a salesperson from Bridgeway Computer in Portland brought him two Leading Technology 386SX units to evaluate. In spite of Leading Technology's national distribution, many would consider the Beaverton, Oregon-based company a third-tier clone manufacturer. But Driggs didn't mind "as long as the PCs worked."

First, the Leading Technology machines were put through a series of rigorous tests on the network. North Pacific systems/program supervisor John Deen, who helps Driggs evaluate machines, stresses the importance of testing PC compatibles in a real work environment, because "clones that work well in a stand-alone situation may have problems on a network." The Leading Technology machines passed the network test with flying colors.

The reliability of components was also a critical consideration. Driggs examined the parts carefully, believing that many clones contained parts that could become obsolete quickly. Leading Technology was appealing, says Driggs, because the manufacturer seemed to stick to familiar parts suppliers. The company uses the renowned Phoenix BIOS and a VGA board from Oak Technology, which manufactures them using an alternative to the Paradise chip set.



THE BOTTOM LINE

PROBLEM:

- Inefficient manual systems
- Each trader needed a desktop computer
- Top-of-the-line PCs too costly

SOLUTION:

- Reliable low-cost 386 clone for each trader
- Interdepartmental LANs to improve communication

BENEFITS:

- Sales nearly doubled
- Traders respond quickly to fluctuating market
- Improved customer service

"We'd had those boards in several different machines even before we started doing business with Leading Technology, and they'd always been quite reliable," Driggs says.

Local support was also important. Driggs believes the dealer responsible for tech support, Bridgeway, gets better response time from Leading Tech because it's also local. And, he adds, Bridgeway's role as a local vendor is crucial. "When you call a software publisher or a hardware manufacturer as an end user, you can spend a lot of time waiting on the line to get an answer to your question," he says, adding that it's better to be able to rely on your dealer for help.

After a 60-day evaluation period, Driggs was sold. "We paid the invoices, and since then we've purchased 35 more SXs."

Dealing With Support Issues

North Pacific's experience with the Leading Technology systems hasn't been perfect, according to Deen. "We've

Building Low-Cost Networks

By purchasing new, low-cost 386SX clones for its traders and upgrading older computers for use as LAN file servers, North Pacific Lumber automated its 11 divisions twice as fast as it could have with name-brand PCs.

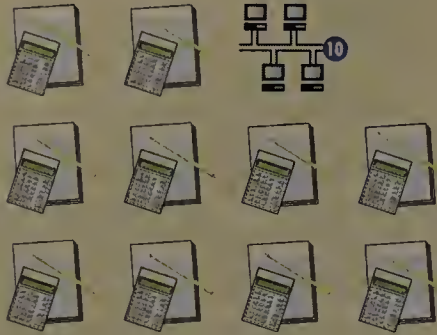

1985: The Beginnings of Automation

The first ten-node IBM PC-based network is installed in the Inland Species Division. Ten remaining divisions still use manual accounting, trading, and inventory systems.

Cost of the network: \$38,607

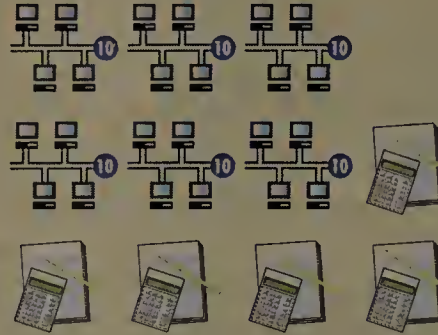

1988: Halfway There

Additional networks are installed in six divisions. Four run on the older IBM PCs, and two use new IBM PS/2 Model 25s. Half the company's traders now work on line.

Cost per network: \$25,826



1990: All Traders Automated

All 11 16-node networks are installed. Twenty-five new 386SX clones replace the PS/2 Model 25s, and the PS/2s replace the old PCs.

Cost per network: \$17,750

had a few boot failure problems," he says. But because the Leading Technology machines come with a standard one-year warranty, boot failures don't upset Driggs too much. "As long as the machine is under warranty, I just ship it to the dealer and let them handle it."

What if one of the Leading Technology machines goes kaput after the warranty expires? It turns out Darrell Driggs is pretty handy with a screwdriver. If a machine has a minor problem, such as a bad power supply, he fixes it himself. However, he adds, "supplier support would definitely be more critical if I couldn't do repairs myself." He suggests companies without on-staff technical wizards or with machines whose warranty has expired should ask a dealer lots of questions: how quickly they can get a replacement model; whether the dealer does repairs in-house or ships them out to third parties; and what the per-hour charge is for repairs. "Getting a third-party company to do your maintenance is also a good idea," he notes.

Boosts in Profits, Productivity

How much money did North Pacific save

by going with the low-end 386SX clones instead of IBMs or Compaqs? From the price quotes he got, Driggs figures 386s from Compaq or IBM would have cost the company \$3000 apiece. The 386SXs cost \$1400 each. "The savings are better than 50 percent. I get two for one."

That savings allowed North Pacific to complete installation of NetWare networks in the few remaining divisions that weren't automated. For example, automating the Pole and Piling Division network—including an upgrade to a Compaq 286 server, ten 386SX machines, network boards, software, and installation—cost a mere \$17,750.

All this automation has boosted both productivity and profits, says Kurt Hutton, vice president and business manager for the Shelter Products Division. "Our traders' productivity has doubled since we set up these systems," he notes. "The traders in our division have jumped from average annual sales of \$2 million per trader to \$3.7 million per trader." In addition, job satisfaction and job knowledge on the part of traders and their assistants has "gone through the roof."

Traders are also able to provide much better customer service. They can access the inventory, order entry, bookings, and freight rate systems over the network. As a result, they can respond quickly to fluctuating market conditions, "bundle" shipments with other traders to achieve a low price for their customers, and keep track of inventory and orders. Eventually, an image processing capability will allow traders to scan in order forms from customers and attach the electronic forms to their own word processing or spreadsheet files, which will eliminate a heavy burden of paperwork.

Vice President Myers is also glad Driggs did some comparison shopping. "We wanted to go with the best and the latest. Darrell convinced me that these 386s will be the right machines for at least the next four or five years." And, Myers adds, the value of the computers has proved immeasurable. "We can have a purchase order to a customer in 5 minutes that used to take two weeks," he says. "It's amazing." ■

David Raths is a freelance writer in Portland, Oregon.

SERIOUS ABOUT COMPUTING? TRY AMERICA'S MOST EXCITING ONLINE SERVICE—FOR FREE!

AMERICA ONLINE UNLOCKS THE FULL POWER OF YOUR PC.

America Online is everything an online service was meant to be.

Need software? Download from a selection of more than 10,000 programs—1,000 new each month—all carefully reviewed for quality and thoroughly described. Finding exactly the software you need has never been easier, or more reliable.

Need advice? Get fast answers from PC experts such as Microsoft, Tandy, and GeoWorks. Scan for objective reviews on thousands of computing products. Participate in live conferences and message boards specializing in games, graphics, educational programs, utility programs, business and productivity applications, and much more. It's like having your own consultant on call, 24 hours a day.

NO OTHER ONLINE SERVICE IS EASIER TO USE.

Our unique graphical interface lets anyone—novice or pro—discover America Online's many services with just a point and a click. There are no puzzling prompts or commands to get in the way.

Get resume advice and career counseling. Manage your investments. Get the latest news and weather. Get homework help for the kids and use a searchable, up-to-date encyclopedia. Join special interest groups and clubs. Save time and money shopping. Find and book the lowest airfares. Entertain yourself with multi-player games, quizzes, movie and book reviews, horoscopes, soap opera news, and much more.

ACT NOW FOR 20% LIFETIME DISCOUNTS!

We're serious about this special free offer! Act now, and get a lifetime 20% discount on America Online's already low hourly connect rates. Return this coupon (or call today) for everything you need to start using America Online—for free! We're so sure you'll love America Online, we'll even give you a free month's membership and a free hour of connect time.

**Download
from a selection of
more than 10,000
programs and files!**

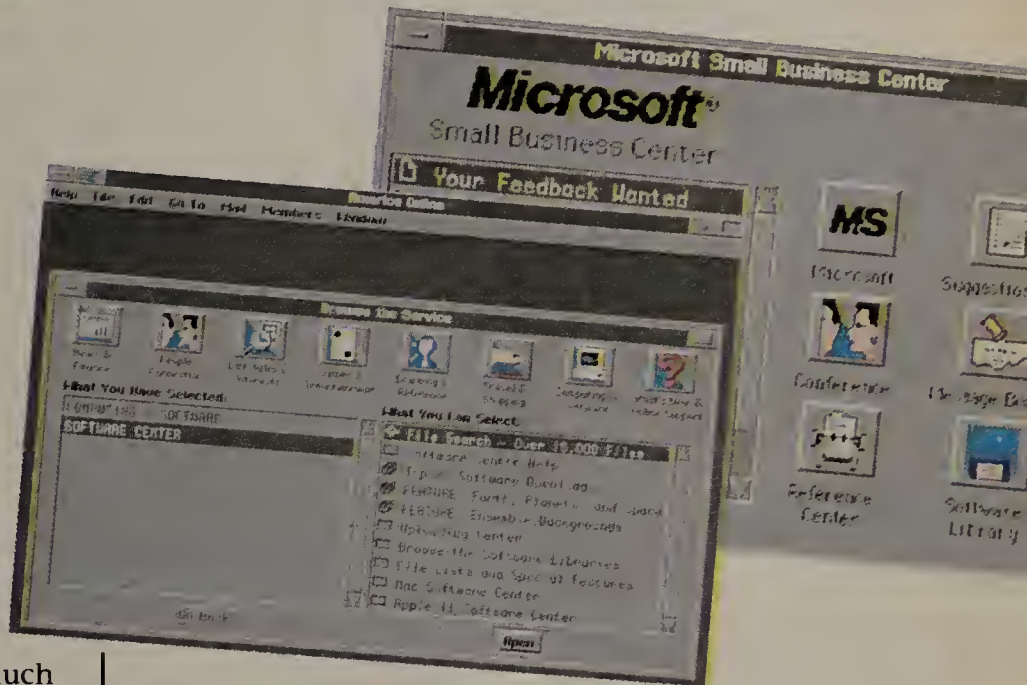

See what's available,
and get there, with just a point and a click.

HURRY! OFFER EXPIRES 10/31/91!

YES! Send me the free software I need to use my free hour of connect time, and waive my first month's membership fee. I understand there's no risk—if I'm not thrilled, I may cancel without further obligation.



NAME _____

ADDRESS _____

CITY _____

STATE _____ ZIP _____

() _____

HOME PHONE _____

You must have a PC/XT or higher; 512K memory or higher; a hard drive; a mouse; a modem; EGA or Hercules monitor or above to use America Online.

DISK SIZE: 3.5" 5.25"

CALL 1-800-827-6364, EXT. 5514 TO ORDER NOW!

THIS COULD BE YOUR LAST PAPER TRANSACTION.

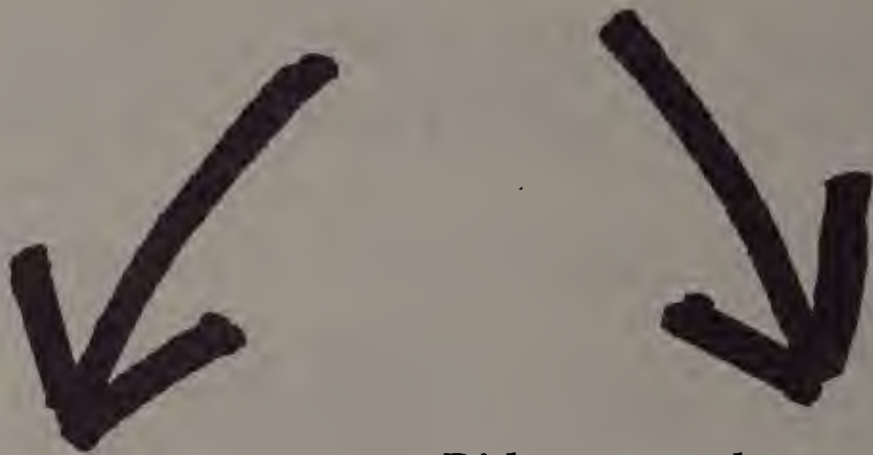

Mail this coupon in today
for your FREE trial of
America Online!

Did someone beat you to our free offer?
Don't worry—call
1-800-827-6364, ext. 5514
to order right now!

NO POSTAGE
NECESSARY IF
MAILED IN THE
UNITED STATES



BUSINESS REPLY MAIL

FIRST-CLASS MAIL PERMIT NO. 8096 VIENNA, VA

POSTAGE WILL BE PAID BY ADDRESSEE

AMERICA
Online

8619 Westwood Center Drive
Vienna, VA 22182-9806



HURRY! OFFER EXPIRES 10/31/91!

FREE TRIAL! FREE SOFTWARE!

YES! Send me the free software I need to use my free hour of connect time, and waive my first month's membership fee. I understand there's no risk—if I'm not thrilled, I may cancel without further obligation.



NAME _____

ADDRESS _____

CITY _____

STATE _____ ZIP _____

() _____
HOME PHONE

You must have a PC/XT or higher; 512K memory or higher; a hard drive; a mouse; a modem; EGA or Hercules monitor or above to use America Online.

DISK SIZE: 3.5" 5.25"

Clip and mail to:
America Online
8619 Westwood Center Drive
Vienna, VA 22182

America Online is a registered service mark of Quantum Computer Services, Inc.



“I use Accounting Plus because it's easy to use, does my accounting and helps me manage my business”

“I have a small business. I'm not a computer expert and I'm not an accountant. With Accounting Plus®, I don't have to be.

Accounting Plus is so easy to use, it seems like it was actually written for people like me.

Yet it's so powerful, my CPA can't thank me enough for using it!

But Accounting Plus does a lot more than balance my books. It actually helps me manage the business, such as tracking my inventory and streamlining my payroll.

Accounting Plus is solid. It's been on the market since 1980, and they've sold more than 60,000 systems. And if I ever have a question or problem, their support people are on top of it.

Going with Accounting Plus? It's the best decision I made for my business!”



(800)222-7701 **Systems Plus, Inc.®** (415)969-7047

500 Clyde Avenue, Mountain View, California 94043

Circle 250 on reader service card

PC Buyers Say Yes to Clones

Price-conscious PC buyers have turned to clones, and few regret the choice.



Roberta Furger

The word is out.

Clones are no longer the risky proposition they were a few years ago. Now organizations of all sizes are opting to buy from the so-called second-tier vendors.

The competitive pricing offered by companies such as AST, Dell, Everex, and Gateway 2000 is what makes most PC buyers turn to clones in the first place, according to a *PC World* satisfaction survey of 250 recent PC pur-

chasers; value and price topped their list of priorities when buying PC compatibles.

Relative newcomer Gateway 2000 boasts the largest installed base of any single vendor among our respondents. No one PC maker, though, claims a commanding lead in this area, with surveyed buyers having purchased PCs from 31 different companies (we present information here on the top ten).

Respondents reported purchasing everything from XTs to full-blown 486s, with the majority (59 percent) buying 386-based systems. Satisfaction is con-

CLONE MAKERS BATTLE IT OUT

No manufacturer can claim a commanding lead among the installed base of IBM compatibles.

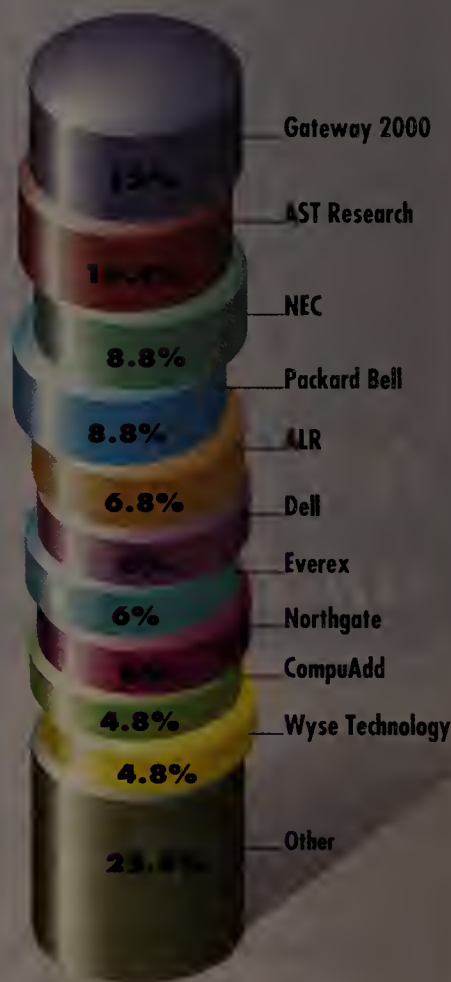

sistently high among those surveyed, regardless of the manufacturer or the class of system purchased.

Although most manufacturers received high ratings in user satisfaction,

SATISFACTION LEVEL HIGH AMONG CLONE BUYERS

Overall satisfaction with product
1=low 5=high

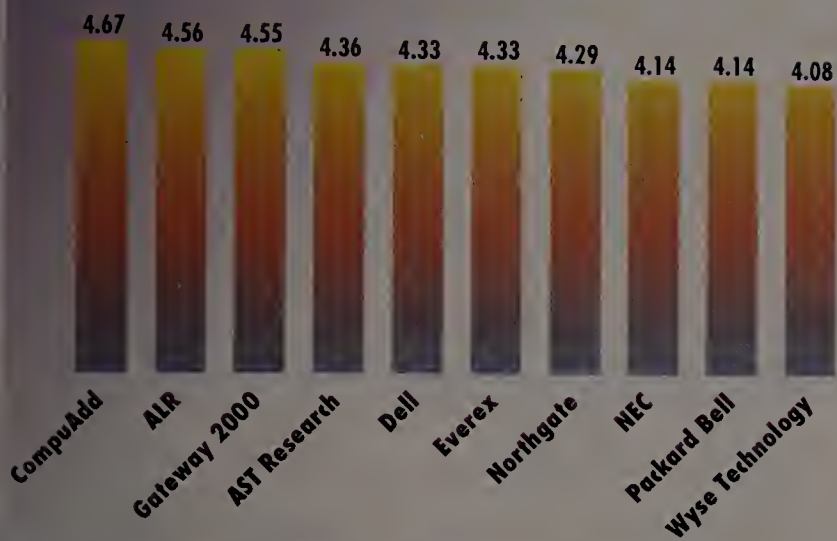

VALUE, PRICE MOST CRITICAL BUYING ISSUES

Users rank important buying criteria
1=low 5=high



EXPANDABILITY, RAM CAPACITY EARN HIGH SATISFACTION RATINGS

1=low 5=high

	Overall	ALR	AST Research	CompuAdd	Dell	Everex	Gateway 2000	NEC	Northgate	Packard Bell	Wyse Technology
Value	4.37	4.38	4.16	4.67	4.43	4.27	4.59	4.11	4.36	4.38	4.20
Expandability	4.36	4.67	4.47	4.64	4.23	4.43	4.50	3.95	4.29	4.17	4.30
RAM capacity	4.35	4.69	4.17	4.55	4.31	4.43	4.54	4.21	4.43	4.05	4.27
Reputation of product or company	4.29	4.25	4.35	4.60	4.50	4.21	4.59	4.35	4.31	3.94	3.11
Design and construction	4.24	4.36	4.45	4.45	4.33	3.93	4.23	4.15	4.46	4.07	4.18
Price	4.22	4.13	4.00	4.25	3.86	4.33	4.66	4.10	4.14	4.15	3.78
Service and support	4.08	4.00	3.89	4.67	4.25	4.00	4.38	4.07	4.29	3.58	3.57
Speed	4.00	4.56	4.54	4.50	4.43	4.60	4.59	3.74	4.54	4.32	4.20

WOULD YOU BUY IT AGAIN?

Owners who would purchase the same system



a surprisingly large number of respondents said they wouldn't choose the same system again. Twenty percent of those who bought a system from Dell said they wouldn't purchase the same

product. Eighteen percent of the NEC buyers thought better of their decision, as did 17 percent of the purchasers of CompuAdd and Wyse PCs. In contrast, all the respondents who purchased a

Packard Bell system said they would buy the same product again. ☉

Roberta Furger is an associate editor for PC World.

IF THERE WERE JUST SAMSUNG WOULD MAKE J



Our compact NoteMaster series delivers performance anywhere.

For all of the employees in all of the businesses everywhere whose computing needs have yet to be met, we offer a single solution.

Samsung.

Rather than let features dictate the design of our systems, we took a different approach. And discovered that four basic form factors met the entire range of business needs.

So our systems come with a feature set that makes each ideal for its intended use. Which means you don't end up paying for features you don't want. Or don't need.



Highly affordable, the DeskMaster 286/386 series is also expandable.

For entry-level users, there's our DeskMaster™ series. It's available in a range of microprocessing power that provides just the right amount of expandability.

Our PowerMaster™ series comes with both the expandability and performance features experienced power users want.

While our 386/486 SystemMaster™ series covers the range of client-server needs, a market we pioneered together with Novell® in the early eighties. So you can expect a great degree of compatibility and reliability.



The high performance PowerMaster 386/486 series offers a high degree of expandability.

Rounding out the Samsung line is our NoteMaster™ series for travelers.

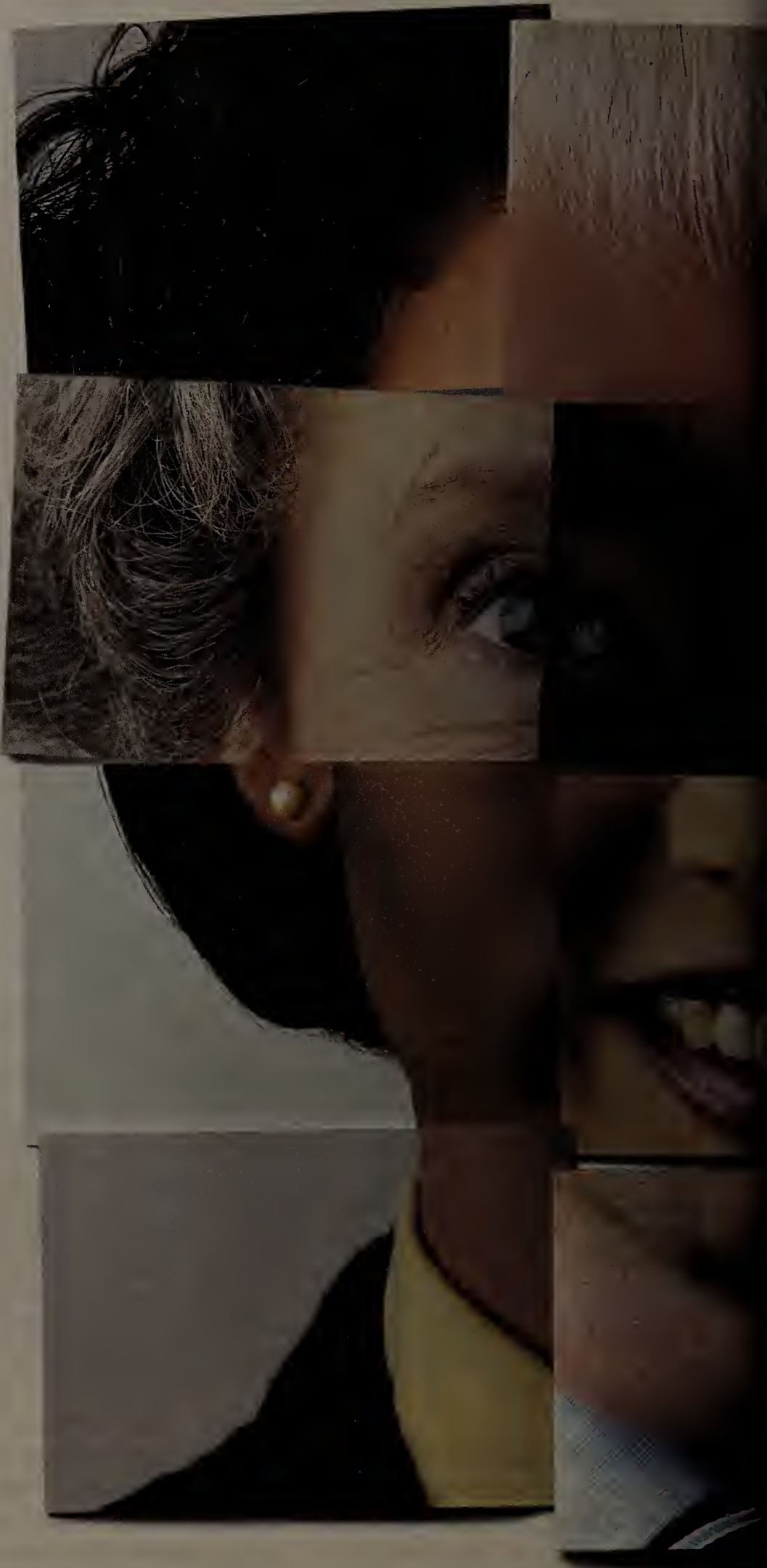

ONE KIND OF USER, BUT ONE KIND OF COMPUTER.

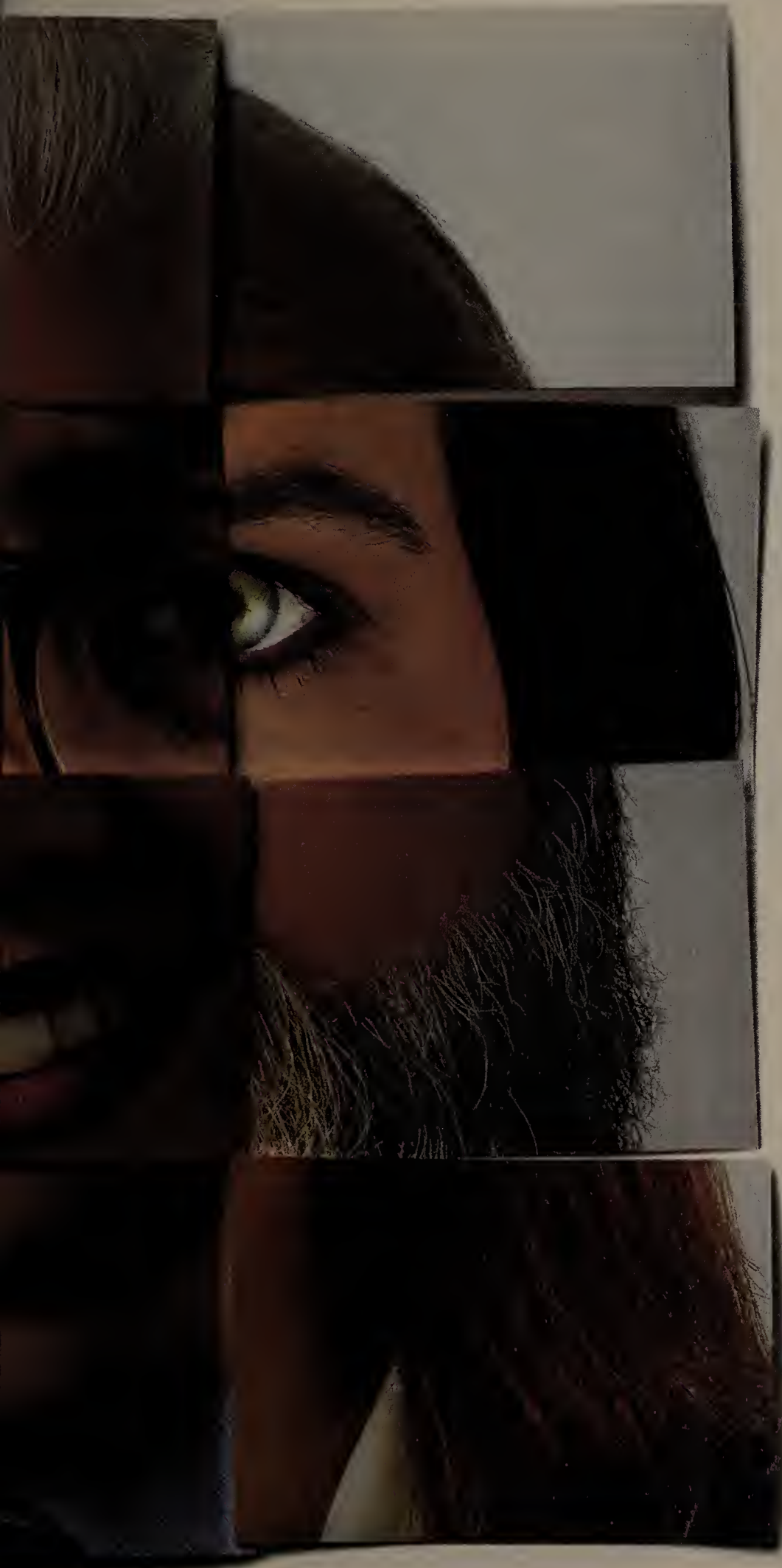

But of course that doesn't round out the Samsung story.

We're the 20th largest corporation in the world. With more than \$35 billion in sales. And an ongoing commitment to R&D to help create what we create best.

Value from today's technologies.

And because there's more to being a Samsung user than using our product, we offer toll-free support for

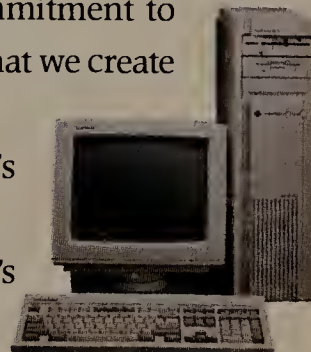

Samsung's SystemMaster can handle even the most demanding LAN needs.

all of our systems, and over 600 locations throughout North America where those systems can be serviced.

Form Factor	Models (Power/Speed)	Memory	Expandability	Power Supply
DeskMaster	286/12	1 to 2MB	3 slots, 3 bays	100W
	386/16	2 to 8MB	3 slots, 3 bays	100W
	386S/20	2 to 32MB	3 slots, 3 bays	100W
PowerMaster	386/25	4 to 8MB	8 slots, 5 bays	250W
	386/33	4 to 32MB	4 slots, 4 bays	200W
SystemMaster	386/33T	4 to 24MB	8 slots, 7 bays	270W
	486/25TE	4 to 32MB	8 slots, 7 bays	300W peak
	486/33TE	4 to 32MB	8 slots, 7 bays	300W peak
NoteMaster	386S/16 (20, 40 & 60MB)	1 to 5MB	Co-processor slot	Standard NiCad

For the name of the Samsung distributor nearest you, call 1-800-624-8999, extension 85AC.

You may find us the best solution yet to your most important need:

Solving everyone else's.



Technology that works for life.

DUE TO THE STRONG GRAPHIC CONTENT OF THIS PROGRAM, USER DISCRETION IS ADVISED.

NEW!
2.1 RELEASE
FREE
TRIAL SOFTWARE

We don't want to infringe on anyone's freedom of expression. But Charisma gives you so many graphic possibilities in one powerful, Windows-compatible program, we felt a warning was necessary.

Limit the number of fonts used to no more than two per presentation. Be consistent and use underlines, italics or bold type for emphasis.

Once you try it, you'll understand why. Charisma's extensive word and data charting functions, real drawing capabilities and total user control make it the most complete graphics solution for business. Unfortunately, some people have trouble resisting the temptation to use every Charisma feature on every presentation. That's understandable.

When you have access to 16.8 million colors, more than 40 fully editable fonts, thirteen drawing tools, a library of 2200 clip art images and the ability to turn any graphic element



Break out information logically and understandably with a variety of chart types. Then use the Harmony Palette for a unifying blend of just the right colors.

into a bullet, it's easy to get a little too enthusiastic. It's just as easy to get overly excited about the way Charisma lets you assemble entire presentations without switching between word processing, graphics and spreadsheet programs. Plus you see the results of your creativity immediately, since Charisma doesn't make you go back and forth between text and graphic



Add visual interest and keep audience attention focused with freeform illustrations or custom edited clip art. One graphic per chart works best.

screens. And with more than 30 import and export filters for graphic formats—including Harvard Graphics—Charisma gives you more power and control than ever before.

But you shouldn't expect any less from a program designed specifically to take full advantage of the Windows environment. Now, even without overdoing it, you can output the most provocative business graphics you've



As you lay out word charts, use a template that provides maximum readability. Add spark to presentations by turning any graphic element, even your company logo, into a bullet. ever seen to 35mm slides, overheads and handouts. Or make your point with SlideShow, Charisma's on-screen graphics presentation utility that includes dozens of transition effects.

Its strong graphic content prompted *InfoWorld's* Michael J. Miller to say, "Charisma offers the greatest flexibility in creating and editing charts that I've seen."

We think you'll agree. Call 1-800-733-3729, ext. 5050 (3710 in Canada) for your free working model of Charisma 2.1*.



8 0 0 - 7 3 3 - 3 7 2 9

*Allow 4-6 weeks for delivery. Micrografx, Inc. 1303 Arapaha, Richardson TX 75081 • (214) 234-1769 (customers outside North America please dial extension 3710). Micrografx has offices in Los Angeles, Paris, London, Munich, Sydney and Copenhagen. Copyright © 1991, Micrografx, Inc. All rights reserved. Micrografx is a registered trademark, and Charisma is a trademark of Micrografx, Inc. All other products are trademarks or registered trademarks of their respective owners. All visual elements created with Charisma.

Windows

A PC World Supplement on Windowing Environments and Applications



Design by Timm Sinclair / Illustrations created by Bud Peen with Corel Draw under Windows 3.0

EDITED BY ANITA AMIRREZVANI

Feature

New Windows on Corporate Data

Managers who don't speak mainframe are using Windows to painlessly access and input company data all across the LAN.

Page 189

Preview

InfoAlliance

Page 196

Reviews

Forest & Trees

Page 199

Q+E

Page 200

Access SQL

Page 202

Road Test

Windows 3.0 users report from the trenches.

Page 206

*Windows data access
software gives you
instant access to
vital company data,
no matter where it
lies on the LAN.*



New Feature Windows on Corporate Data

Sharon Fisher

Like most companies across the country, Maritz Motivation Company in St. Louis wants to improve its managers' access to critical data. Maritz provides motivation, travel, communications, training, and research services to clients. Currently, several of Maritz's many field offices report their sales data every night to a VAX minicomputer located at the company's headquarters, where the data is then consolidated. But that wealth of information is difficult for top executives to access directly.

"Right now, the obstacles in getting to information mean that people are managing by the seat of their pants—by hunches and gut feel as opposed to facts," says John Roth, Maritz's manager of executive support systems. Roth is not alone in attempting to solve a problem that has plagued the business world for years: How do you provide employees with effortless access to valuable corporate data—data that is usually stored somewhere on an inhospitable minicomputer or mainframe?

In the past, employees had to rely on the corporate MIS department to retrieve the data they needed. Or they could use *terminal emulation* software, which enables PCs to act like IBM 3270 and DEC VAX terminals. But this software forces users to grapple with complicated emulation modes and mainframe application interfaces, and it requires expensive connectivity hardware.

At Maritz, a new executive information system due this fall will change all that. PCs will run an application developed with *SQLWindows*, a development tool from Gupta Technologies

for creating graphical interfaces. The application will allow Maritz executives to use a *Windows* front end to query an *Oracle* data base on the VAX without having to jump through hoops. Instead of asking an analyst to research a question about sales prospects or forecasts, an executive will be able to click a button and access the information in an easy-to-understand format. "We're doing this to improve executives' access to timely information, which will help us sell more and sell better," says Roth.

■ Power to the Manager

New data access technologies are finally making the dream of enterprisewide access to information come true. Soon, it will be possible for managers to get all the critical data they need, whenever they need it—regardless of where that data is stored on the network. Data access tools are founded upon a "client-server" architecture, which separates processing functions from user interfaces. These tools tie together disparate users, applications, and systems with a common, comprehensible interface. By bringing critical data to managers and translating it into timely information they can use, these products can make a difference in the company's bottom line.

Not surprisingly, *Windows* is the favored environment for data access tools, chiefly because it's easy to work with. "People with *Windows* front ends can access inhospitable hosts and get to data that was traditionally kept from them," says Richard Holcomb, vice president of marketing for Pioneer Software, which sells the data access tool *Q+E* (see the review in this section).

Q+E and many products like it gather data from corporate data bases and present it on an easy-to-use front end. An executive can request data simply by pointing and clicking; the data access program translates the request into a standard data base query, often in Structured Query Language (SQL), the Esperanto of data base languages. The SQL command extracts the results from the SQL data base, which can reside on a mainframe, a mini, or a super-powerful, dedicated 386 or 486 PC. The data base, in turn, sends those results back to the executive's *Windows* application.

Besides ease of use, a key reason for the popularity of *Windows* as a home for data base front ends is its ability to create *hot links* between applications. With *Windows*' built-in Dynamic Data Exchange (DDE) capability, developers can set up links to transfer and update data automatically between, say, a SQL-capable *Windows* product and *Excel*. Managers can then see the numbers change in the spreadsheet in "real time" as the actual data changes.

Graphics Vision™ 1024 for advanced *Windows*™ applications: the perfect balance of performance and price.



Plug in the Graphics Vision 1024 board and your 256-color applications fly.

Its built-in coprocessor and video RAM remove the video burden from your main system for dramatic improvements in both system speed and graphics.

Even if you don't need more than VGA right now, you'll be prepared for the future. In fact, the slower your system, the more it will benefit from the Graphics Vision 1024.

Graphics Vision 1024 features Windows-

optimized drivers, the most important factor driving video performance under Windows. Resolution to 1024x768 non-interlaced. Support for all graphical user interfaces and popular monitors. Everything you need for superior display.

All for just \$695 suggested retail price. Now, that's balance.

Look at the Graphics Vision 1024 and you'll see everything clearly. Call 1-800-422-7369 for the dealer nearest you.



The New Vision in System Solutions

Graphics Vision is a trademark of Applan Technology, Inc. Windows is a trademark of Microsoft Corporation.

Circle 22 on reader service card

dWindows!

(from Borland)



Borland's new ObjectVision™ lets you create Windows applications that directly access dBASE files. Now it's easy to get the graphical Windows environment you want *and* access to your dBASE files. And developing ObjectVision applications is fast because there is *no programming required*.

ObjectVision transparently connects to all of your corporate data including Paradox®, Btrieve and ASCII files, as well as to other Windows applications via DDE. You can even access Paradox and dBASE files in the same multiuser environment making it the ideal Windows front end for all your data.

ObjectVision.

The power of visual programming.

Creating an attractive forms user interface is easy using ObjectVision's visual programming. You simply draw the elements of your application on the screen using ObjectVision's WYSIWYG graphical tool. Add the program's underlying logic by drawing intuitive decision trees. Then, as simple as a mouse click, create data links to connect the fields in your

application with the fields in your database. It's that simple. And that powerful.

All of ObjectVision's applications are developed incrementally, like a spreadsheet. So when you add new logic, or modify an object, you see results *instantly*. There's no waiting through an edit/compile/test cycle.

No extra royalty fees with ObjectVision Runtime!

For a one-time price of \$495 you can take advantage of ObjectVision Runtime (sold separately). Runtime allows you to develop and distribute ObjectVision Windows applications to an unlimited number of users. All without extra royalties!

dOFFER!

Now, for a limited time* you can buy ObjectVision for ONLY \$99⁹⁵ (a tremendous savings off the \$495 list). And it comes with our standard 60-day, money-back guarantee. You risk nothing. **See your dealer** or call **1-800-331-0877** today.

B O R L A N D
Software Craftsmanship

CODE: MV40

*Offer good until September 30, 1991. Pricing is in U.S. dollars. Dealer prices may vary. Offer good in U.S. and Canada only. Copyright © 1991 Borland. 1800 Green Hills Road, P.O. Box 660001, Scotts Valley, CA 95067 BI 1411

Circle 13 on reader service card

Windows data access and development tools cross a wide spectrum. Some, like *Forest & Trees*, are simply front ends aimed at executives who need to look at data in existing data bases. Others, like *Access SQL*, include a front end along with a data base server, allowing specified users to update data and developers to create forms-based applications for end users. Still others, like *Easel/Workbench*, are full-blown development tools for programmers, providing maximum control in creating front ends as well as in structuring a data base from the ground up.

■ Innovative Applications

At present, most organizations that are implementing *Windows*-based data access applications are still in the design stage. At the Rand Corporation in Santa Monica, California, programmers are working on an integrated modeling system for military clients that embraces PC applications such as *Excel*, *PowerPoint*, and *Word*; relational data bases on mini-computers and mainframes; and matrix computations written in C language that run on Sun workstations.

When completed, the application will allow users to model the future of the military's personnel, incorporating information such as what percentage are likely to be promoted or leave the service. "We have plans to reduce the size of the military force, and we need to figure out the effect of different policies," says Rand economist Jonathan Cave. With the application, Cave will be able to use *Excel* as a front end to access statistics

stored in the relational data base on the server, such as personnel records and numbers of reenlistments. He can then pull the data together in an *Excel* spreadsheet.

Improving executives' access to information is the goal at the business systems consulting group of Arthur Andersen Company in Boston, where partner Mark Tino is designing applications that give executives timely access to their own company's data base, so they can get a clearer sense of the direction the business is taking. Once completed, the application will deliver data about such critical success factors as the quality of customer service or the profitability of certain divisions. It will also let executives use *Lightship*, a *Windows*-based management reporting system, to do what-if modeling and help them locate problem areas.

The main purpose of Tino's application will be to "help clients think through what business information is important and how to look at it." The beauty—and the difficulty—of the process is that it requires figuring out what crucial information is lacking. "When you get executives to rethink their needs, many of them realize that the information they really need isn't available. It doesn't exist because they've never asked the questions before," says Tino.

■ Grappling With Data Integrity

Naturally, data stored on a mainframe or a minicomputer is well protected partly because it's so difficult to reach. Granting easy to access to just about anyone, on the other hand,

Guide to Windows Data Access Tools

Here's a list of *Windows* data access products. The list includes easy-to-use front ends as well as application development tools directed at programmers. For information on *Forest & Trees*, *Q+E*, *Access SQL*, and *InfoAlliance*, see the reviews that follow in this section.

Choreographer

This graphical user interface development environment is used to create large-scale applications.

GUIDance Technologies
800 Viniol St.

Pittsburgh, PA 15212
412/231-1300,

412/231-2076 (fax)

LIST PRICE: \$7500

Reader service no. 758

Easel/Workbench

Using this set of software development tools you can build graphical applications that run on *Windows*, *OS/2*, and *DOS* platforms.

Easel Corp.

25 Corporate Dr.

Burlington, MA 01803

617/221-2100,

617/221-3099 (fax)

LIST PRICE: \$11,900

Reader service no. 759

Executive Query Tool

Access data from *SQL Server*, *Oracle*, *DB2*, and other data bases with this front end.

Telebit Corp.

1315 Chesapeake Terr.

Sunnyvale, CA 94089

408/734-4333,

408/734-3333 (fax)

LIST PRICE: \$695

Reader service no. 760

Mezzanine

This network server program provides document management for network applications. Two third-party front ends are available: *reQuest* and *Viewz*.

Soros Corp.

10900 N.E. 8th St. #700

Bellevue, WA 98004

800/827-2767,

206/462-0879 (fax)

LIST PRICE: server version

\$2950; *reQuest* \$495

per user; *Viewz* \$345 per

user

Reader service no. 761

Nevisys

Scheduled for release in August, this client-server authoring environment targets Fortune 500 companies that want PC-based access to mainframe data.

Nevis Technologies

300 Corporate Pointe

#440

Culver City, CA 90230

213/338-0257,

213/338-8563 (fax)

LIST PRICE: not available at press time

Reader service no. 762

Object/1

This development environment creates graphical user interfaces for accessing data from *SQL Server*, *mdb4*, and *IBM Data Base Manager*.

Micro Data Base Systems, Inc.

Two Executive Dr.

P.O. Box 6089

Lafayette, IN 47903

317/447-1122,

317/448-6428 (fax)

LIST PRICE: \$995

Reader service no. 763

ObjectView

Developers can build *Windows* applications for *SQL*

Accessing Data the Windows Way

Working with a familiar Windows program, a manager can request data simply by painting and clicking.

The data access program translates the request into a data base query language and sends the request to the mainframe, mini, or server system where the data resides.

The data is retrieved and routed back to the manager, who receives it in the Windows application.

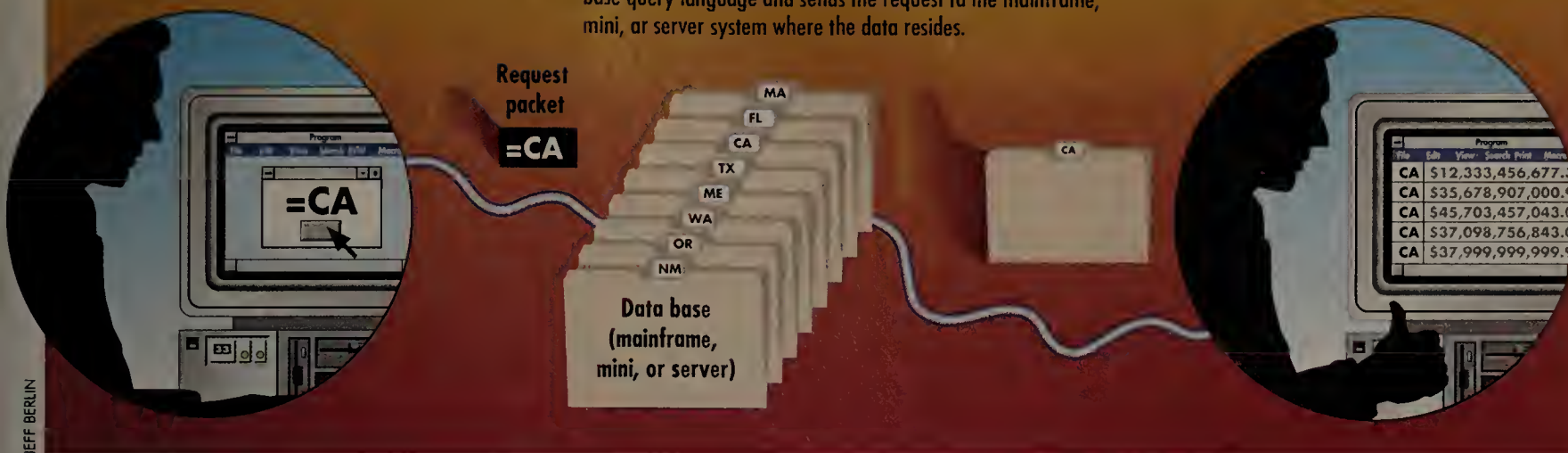

causes concern among MIS directors, who need to make sure that critical data remains both uncorrupted and secure.

Their concern stems from the update features of most data access tools, which allow users to make changes to live data on the server. Another potential source of worry is user access to sensitive or classified data. In order to deal with these questions, administrators must be very careful when deciding who is allowed to access or update certain kinds of data; these privileges can be controlled using the traditional methods of establishing data entry and data access rights for each user.

Many MIS directors are cautiously implementing pilot projects to test the limits of the new software, which is usually designed to make it easier for IS managers to set up multiple levels of security. Software Publishing's *InfoAlliance*, for example, provides built-in, mainframe-like data integrity and security features that allow administrators to set up read-only

views for some people, while providing others with both read and write privileges.

■ A Bright Future

Given the cost of redesigning corporate data systems, not to mention the "political" issues that often emerge in the who-owns-the-data struggle, it's going to be a while before systems that provide enterprisewide data access really take off. But in the long run, these systems have the potential to give managers new and ingenious ways of viewing and using their data. By turning hard-to-get-at data into viable information, data access products promise to change business computing dramatically for the better. Eventually, managers will be able to identify trouble spots, make more accurate projections, and solve problems more creatively—based on a better understanding of the inner workings of their business.

Server using icons, pull-down menus, and tables.

Matesys Corp.
900 Larkspur Landing
Circle #175
Larkspur, CA 94939
415/925-2900,
415/925-2909 (fax)
LIST PRICE: \$899
Reader service no. 764

Omnis 5

Developers can create graphical applications that support SQL and that are portable between PCs and Macs.

Blyth Software Inc.
1065 E. Hillsdale Blvd.
#300
Foster City, CA 94404
415/571-0222,
415/571-1132 (fax)
LIST PRICE: \$1000
Reader service no. 765

PC/SQL-Link Windows Requester

This front end can access data stored in a variety of relational data base formats, including *SQL Server* and *DB2*.

Micro Decisionware
2995 Wilderness Pl.
Boulder, CO 80301
303/443-2706,
303/443-2797 (fax)
LIST PRICE: \$240-\$720
Reader service no. 766

PowerBuilder

Build large-scale client-server applications with a graphical interface using this development tool.

Powersoft Corp.
70 Blanchard Rd.
Burlington, MA 01803
800/395-3525,
617/273-2540 (fax)
LIST PRICE: \$2995
Reader service no. 767

SQL Commander for Windows

Provides data access in SQL data bases.

Datura Corp.
1926 E. Parham Rd.
Richmond, VA 23228
804/264-1225,
804/264-1297 (fax)
LIST PRICE: \$195
Reader service no. 768

SQL Server Library

Using this *Windows Workstation* utility, you can run applications written for Gupta's *SQLWindows* with Microsoft's *SQL Server*.

Automated Design Systems
375 Northridge Rd.
#270
Atlanta, GA 30350
800/366-2552,
404/394-2191 (fax)
LIST PRICE: five-user version of *Windows Workstation* \$495;

unlimited number of users \$1995

Reader service no. 769

SQL SoftLink

Developers can connect *Windows* applications to *SQL Server* using *DDE*.

SQLSoft
10635 N.E. 38th Pl.
Bldg. 24, Suite B
Kirkland, WA 98033
206/822-1287,
206/822-1485 (fax)
LIST PRICE: five-user version \$495

Reader service no. 770

SQLWindows

Developers can create graphical applications for *SQL* data bases. *Quest* is a new ad-hoc querying tool expected in June.

For more information about all the products listed in this section, circle reader service no. 909.

Gupta Technologies
1040 Marsh Rd.
Menlo Park, CA 94025
415/321-9500,
415/321-5471 (fax)
LIST PRICE: *SQLWindows* \$1295; *Quest* \$495
Reader service no. 771

Superbase 4

This relational data base and development system is used to create client-server applications.

Precision, Inc.
8404 Sterling St.
Irving, TX 75063
214/929-4888,
214/929-1655 (fax)
LIST PRICE: single-user version \$695; five-user network extension \$995
Reader service no. 772

Make Your Accounting Clear and Simple. Crystal Accounting for Microsoft Windows 3.0



There's a Peachtree Accounting Product for Every Small Business.

Crystal Accounting™



The Clear Choice for Windows Accounting.

Includes General Ledger, Accounts Receivable, Invoicing, Accounts Payable, Payroll and Financial Report Writer.

\$495

Peachtree Complete® III



The Biggest Value in Small-Business Accounting.

Includes General Ledger, Accounts Receivable, Invoicing, Accounts Payable, Inventory, Purchase Order, Payroll, Fixed Assets and Job Cost.

Winner of the 1990 Computer Shopper Best Buy Award

\$199

Peachtree Double Bonus Bundle™

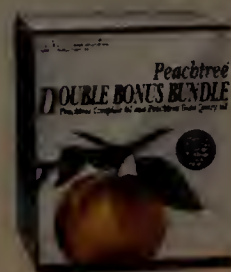

The Top Accounting Value with the Added Benefit of Custom Reporting.

Includes Peachtree Complete III Accounting modules plus Peachtree Data Query. PDQ gives you easy access to the information in your accounting system for the purpose of creating custom reports.

\$298

Accounting software have centered around a competitive war of features. Peachtree Accounting breaks that barrier with a fresh new product that will forever change the way you view their financial picture. Crystal Accounting™ combines the best of both worlds: accounting functionality with the visual appeal of Microsoft Windows 3.0™ to bring you a new way of performing traditional tasks in a way that feels entirely new.

Why Peachtree Accounting? Productivity is the biggest benefit Windows brings to accounting software. Crystal Accounting uses the intuitive graphical interface and logical pull-down menu system to present accounting features that are faster to learn and easier to use, a savings that will pay off for your business now and in the future. And once you learn Crystal Accounting, you'll generally know how to use all Windows applications.

Information is more accessible in Crystal Accounting and can be displayed in multiple windows on the screen. Background processing is also a time saver. For example, you can print checks in one window while you perform other tasks in another.

Crystal Accounting supports multiple currencies when you enter transactions. You can enter transactions in any currency and the program will automatically convert them to your base currency.

Crystal Accounting is designed to be easy to learn and easy to use. The program includes a comprehensive on-line help system that provides detailed information on every feature and function.

Crystal Accounting is designed to be easy to learn and easy to use. The program includes a comprehensive on-line help system that provides detailed information on every feature and function.

Crystal Accounting is designed to be easy to learn and easy to use. The program includes a comprehensive on-line help system that provides detailed information on every feature and function.

Crystal Accounting is designed to be easy to learn and easy to use. The program includes a comprehensive on-line help system that provides detailed information on every feature and function.

Crystal Accounting is designed to be easy to learn and easy to use. The program includes a comprehensive on-line help system that provides detailed information on every feature and function.



Crystal Accounting modules are fully networkable and can handle an unlimited number of transactions, customers, vendors, employees, companies and cash accounts. This is an accounting program that can expand along with your business.

Generating reports with Crystal Accounting is as straightforward as a mouse selection, but flexible enough to give you exactly the information you need in the format you want. You have nearly 100 options for designating the font, font size, style and overall format of reports. All reports can be reviewed on screen, from start to finish, in detail or summary format.

The Financial Report Writer further expands reporting options with an interactive General Ledger that allows you to create a variety of ways to view and print your financial statements. Crystal Accounting prints checks, W-2s, 940s, 1099s, invoices, cash flow statements and more.

Why Peachtree Accounting?

Crystal Accounting is priced at \$495, and when purchased from Peachtree Software, carries a 60-day money-back guarantee. A \$25 restocking fee does apply to product returns.

Peachtree also stands behind its products with a toll-free number for telephone support. As a registered Peachtree user, you may receive support on a pay-per-call basis using a major credit card or prepaid through the PeachCare™ program. Although Crystal represents an entirely new type of accounting software, you can be comfortable with the fact it is published by Peachtree Software, the leading supplier of microcomputer accounting products.

System Requirements

Crystal Accounting requires at least an IBM AT or compatible with a hard drive; 640K of memory (1 Meg is highly recommended); an EGA, VGA or Hercules Graphics Card; DOS 3.1 or greater, and Windows 3.0 or greater. A mouse is highly recommended.

Call Now to Order

or for a dealer near you.

1-800-247-3224

404-564-5800 / FAX 404-564-5888

\$495

Plus \$7.50 Shipping and Handling
(in Georgia, add applicable sales tax)

Crystal Accounting is a trademark of Peachtree Software Incorporated. All other trademarks are owned by their respective companies.

atOnce!®

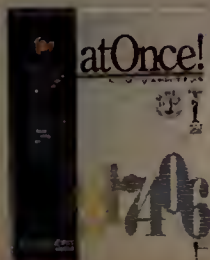

Macintosh Accounting as Easy as It Gets.

Includes General Ledger, Accounts Receivable/Billing, Accounts Payable and Payroll.

Winner of the MacUser Editor's Choice Award and the MacWorld World Class Award

\$395

INSIGHT EXPERT™



The Power to See Beyond the Numbers for Macintosh Users.

Includes General Ledger, Accounts Receivable/Billing, Accounts Payable, Inventory, and Payroll.

Winner of the MacUser Editor's Choice Award and the MacWorld World Class Award

\$695 per module



Peachtree Software®

1505 Pavilion Place, Norcross, GA 30093

PCW

Circle 144 on reader service card

InfoAlliance

Data Access Software

Preview

Robert M. Gentry
& Robert C. Bolt

Your wholesale auto parts operation seems to be held together with baling wire. You keep inventory data in SQL format in IBM OS/2 Extended Edition and your customer list in *dBASE*. To take an order, your salespeople have to print out the inventory data and then move to another PC to input part numbers and prices manually in an order form. To find out how forecasted inventory levels compare with actual inventory, you load *1-2-3* and then jot down the comparisons to input elsewhere. The result: slow and inaccurate data entry and reduced ability to track and analyze trends in your data.

Until *InfoAlliance* appeared, the only way to organize this crazy quilt was to start from scratch, painstakingly restructuring your data within a single data base. Now, with *InfoAlliance*, you can gather this data in the same custom-designed application and print out invoices, reports, and marketing letters. You don't even have to know where the data you want resides or what its file format is. You simply specify that you need the inventory file, and *InfoAlliance* delivers it to your screen.

Originally shipping late last year as an OS/2 *Presentation Manager* program, *InfoAlliance* will soon offer a *Windows* front end that can work with existing *Presentation Manager* front ends on a network. The *Windows* version will provide all the same features,

including querying, reporting, and form creation tools, and an impressive application generator. The smooth windowing interface is also nearly identical, offering well-designed dialog boxes, pull-down menus, and icon shortcuts.

As with Xerox's *FormBase*, you use graphical on-screen forms to enter, query, and view data. When you're ready to analyze the data, you can create simple, predefined columnar reports or design elaborate form-based reports—and even use bit-mapped graphics (a company logo, for example).

An updated version of the core product, due out in late August with the *Windows* front end, will support Dynamic Data Exchange (DDE) and Microsoft's *SQL Server*, for improved data sharing with other *Windows* applications. Currently *InfoAlliance* can draw upon *dBASE*, *1-2-3*, IBM OS/2 Extended Edition Database Manager, and

native *InfoAlliance* data.

Keep in mind that *InfoAlliance* is a major department or company investment. The price is likely to be steep (the previous *Presentation Manager* version cost \$8500 for 10 users), and you'll probably need a part- or full-time administrator. But it's one of the few programs that can make sense of information scattered throughout different data bases.

S N A P S H O T

InfoAlliance for Windows 1.1

A client-server data manager that lets users query and integrate SQL, *dBASE*, and *1-2-3* data, the latest version of *InfoAlliance* offers a slick, form-based *Windows* front end.

KEY FEATURES

- Front end to *dBASE*, *1-2-3*, and IBM OS/2 Extended Edition Database Manager data
- Complete form design and querying
- Report writer and application generator

AVAILABILITY

Late August

PRICING

Unavailable at press time

Software Publishing Corp.

1901 Landings Dr.
Mantain View, CA 94043-7210
415/962-8910

Reader service no. 674

ORDER NUMBER: 000145

CHOCOLATE International Sales ID: TE
Salesperson: ***

Shipping Order Number: 000146 Pat Method: P.O.
Customer ID: 0002 PO# require: 123

Order Date: Jan. 15 1991 Ship Date: 1/17/1991 Shipped by: CG

Bill To	Ship To	Totals
Choc 'o Lot 20202 E. Main Avenue Box 10 Los Angeles CA 92122 USA	Choc 'o Lot 20202 E. Main Avenue Box 10 Los Angeles CA 92122 USA	Total Amount: \$ 5,175.00 Discount: 310.50 Sales Tax: 291.87 Order Amount: \$ 5,156.37

Product	Description	Qty On-hand	Price	Quantity	Amount
10007	Milk Crisp Bar 48/3	***	€0.00 /case	75 Cases	1,500.00
10002	Almond Bar 48/3	***	€2.50 /case	50 Cases	1,125.00
10006	Milk Bar 48/3	***	€9.50 /case	75 Cases	1,575.00

InfoAlliance for *Windows* lets you use the common business form as your window on a wealth of information drawn from different *dBASE*, *1-2-3*, and SQL data sources.

WordScan™ The Most Accurate OCR You Can Buy.

And We'll Prove It.

ognition we build into our hig
ces. Our unique **pop-up** editor
sults
e cha
o the
marie
ther OCR products. You can eve
it accurately recognizes un

POP-UP

Our unique Pop-Up Verifier™ guarantees the most accurate results possible. Proof twice as fast without referring to the original document.

We started with the lowest error-rate OCR technology in the industry. Then we added exclusive features to make WordScan even more accurate. With WordScan you get the same state-of-the-art recognition we build into our high-end systems, at desktop prices.

Powerful features make WordScan even more accurate.

Our unique *Pop-Up Verifier* guarantees the most accurate results possible. It pops up an enlarged image of any questionable character or word so you can proof without referring to the original document.

And because WordScan uses dictionaries during recognition, we don't make mistakes common to other OCR products. You can even add your

"WORDSCAN PLUS
REDEFINES WHAT WE EXPECT
FROM AN OCR PACKAGE. ITS
EXCEPTIONAL ACCURACY, WEALTH
OF FEATURES, AND HANDS-OFF
DESIGN SET A
NEW STANDARD."
—PC MAGAZINE



own words so WordScan accurately recognizes unusual or specialized terms.

Zap figures or text right from a fax card to your word processor or spreadsheet. No fuzzy print-outs. No retyping. No errors. And only WordScan has built-in dot-matrix support to read even draft quality dot-matrix documents *accurately*. Most OCR products can't do this at all or charge you extra.

Other unique WordScan features get the job done faster, better.

Clipping, another WordScan timesaver, lets you choose just what you want on the page. Text, image, or both. All in one pass.

Deferred Processing™ lets you scan large documents now, but do OCR later so your PC is not tied up.

Make different documents look the same with our exclusive *Style Sheet* feature.

Process multiple documents into separate files automatically. Just put a blank page between documents and WordScan does the rest.

We'll send you the proof.

To see the results of head-to-head, real-world comparison tests with the leading competitive OCR software products, or to get the name of a dealer where you can make the comparisons yourself, just give us a call at 800-544-7051.



Also available in French and German.

CALERA
RECOGNITION SYSTEMS

2500 Augustine Drive, Santa Clara, CA 95054 USA. 800-544-7051; outside USA, 408-986-8006; FAX 408-986-1440

© 1991 Calera Recognition Systems, Inc. Calera® is a registered trademark of Calera Recognition Systems, Inc. WordScan, PopUp Verifier and Deferred Processing are trademarks of Calera Recognition Systems, Inc.

Circle 47 on reader service card

Forest & Trees for Windows

Data Access Software

Review

Robert M. Gentry
& Robert C. Bolt

A manufacturing executive at a large company types a memo in *WordPerfect* under *Windows 3.0*. Suddenly, an alarm issues from his PC and a note pops up, warning him that inventory of a key material has fallen dangerously low. The name and phone extension of the appropriate buyer also appear in the note, so the manager can instruct the buyer to correct the problem, averting a potential disaster in the nick of time.

Forest & Trees for Windows, a SQL front end by Channel Computing, can gather such critical information from disparate sources—PCs, minicomputers, mainframes—and combine it into a single customized on-screen report.

Forest & Trees' Query Assist feature allows users to set up simple SQL queries using a point-and-click interface. For complex queries, however, most executives will probably turn to an in-house developer. Using the program's application generator, a developer can set up a series of queries and display their results in a customized dashboard of "views"—windows that display vital signs like cash position. Clickable icons set up by the developer let users update the query rapidly to obtain the latest data, read and write notes, display graphs and reports, or show an information "tree" that depicts a given view's relationship to other data.

Forest & Trees offers an alarm that can include a calculation of, for example,

how far off budget this week's figures are. Visual alarms can be set to pop up if expenses exceed budget by more than a given percentage. With *Forest & Trees'* timed-query capability, the information can be gathered automatically, every Monday morning, say.

When it's time to analyze the results of a query, managers can take advantage of *Forest & Trees'* report-generation and graphing capabilities. You can build an impressive array of graphs and even display them on your "dashboard." However, to print graphs, you must export them or move them via the *Windows* Clipboard to other applications.

At press time, *PC World* learned that the upcoming version 2.0 of *Forest & Trees* will allow users to perform certain complex SQL functions, such as joining tables, by pointing and clicking

instead of typing in commands. Additionally, users will be able to display entire tables in views instead of only single columns of data. A free upgrade will be available to all registered users.

Forest & Trees' Standard Edition costs \$495 and allows you to access data in 1-2-3, *Excel*, *dBASE*, *R:base*, *Paradox*, flat files, and ASCII files. Version 2.0 will provide a \$1495 Client/Server Edition that bundles support for *Oracle Server*, Microsoft's *SQL Server*, and Gupta's *SQLBase*. An optional interface is available to *DB2*, IBM's mainframe data base, through Micro Decisionware.

Unlike data base server front ends such as *Q+E* and *Access SQL*, *Forest & Trees* can't add or update records in a data base. It appeals to managers who continually need to monitor fast-changing data stored on a LAN, a mini, or a mainframe. It's especially good for executives who want a data access program that converts critical corporate data into meaningful information.

WHERE TO BUY

Forest & Trees for Windows 1.0

Channel Computing, Inc.
53 Main St.

Newmarket, NH 03867

800/289-0053, 603/659-7590 (fax)

List price: \$495 Standard Edition, \$1495 Client/Server Edition

REQUIREMENTS: 2MB RAM, Windows 3.0, hard disk

TECHNICAL SUPPORT: unlimited, toll-free number, M-F 8-8

OTHER SUPPORT: 60-day money-back guarantee

Reader service no. 641

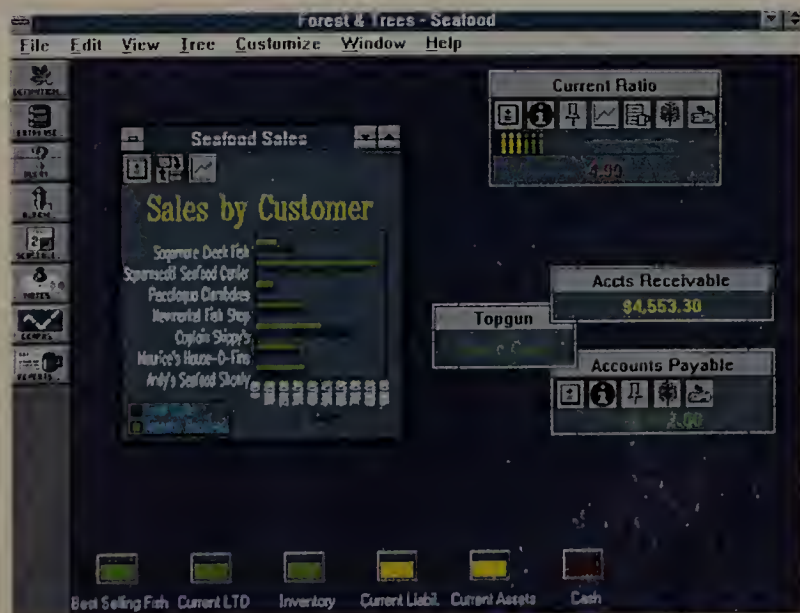

Forest & Trees allows you to create a customized "dashboard" displaying the results of queries. The results of a query can be a number, a list, or even a graph.

Data Access Software**Q+E
Review**

Robert M. Gentry
& Robert C. Bolt

A purchasing executive for a chain of supermarkets orders fresh produce every week. Using *Excel*, she forecasts purchasing requirements, runs what-if scenarios, and creates graphs to use in contract negotiations. But the process has a weak link: The executive can't obtain timely sales figures from the stores. The data she needs resides in an *Oracle* data base on a minicomputer, and requested reports don't reach her for at least a week.

Q+E, a multipurpose data base access tool from Pioneer Software, helps solve this type of problem. A knowledgeable user could create *Excel* macros that call *Q+E* functions, providing the purchasing executive with point-and-click access to the required minicomputer data base information and graphing it automatically as well.

The name *Q+E* stands for *query and edit*, the product's basic data base functions. The querying portion enables

you to draw data from diverse sources, while the editing tools allow you to update data in the source data base, unlike with *Forest & Trees*.

Q+E's main strength is working as an ad hoc query tool, and it makes creating queries as easy as *Access SQL* does. You create a query by pointing and clicking; the actual SQL statements are built for you behind the scenes. After you open a table, you can refine the query by simply highlighting specific columns or cells. More complicated querying, such as the purchasing executive needed, must be set up by power users familiar with DDE and *Windows* application macros.

In addition to querying data bases, *Q+E* allows you to update, delete, and add records as well as create and define new tables and data bases. Some important built-in safeguards help data base administrators manage all this power. At installation, they can choose full ca-

pabilities or limit *Q+E* to a read-only version. Anyone working with a fully capable copy must select an Allow Editing option in order to modify data in a query window. This step prevents users from inadvertently writing changes to the underlying data base.

Q+E can draw data from a healthy menu of sources. Its \$199 standard edition accesses *dBASE* and compatibles and *Paradox*, as well as ASCII text files and *Excel* files. A \$299 server edition adds Microsoft's *SQL Server*, *Oracle Server*, *Sybase*, IBM OS/2 Extended Edition Database Manager, IBM's mainframe data base (*DB2*), and Novell's *NetWare SQL*. Additionally, Microsoft makes its own add-in version of *Q+E* available free to registered *Excel 3.0* users. This version supports only *SQL Server*, *dBASE*, and ASCII files.

Unlike *Access SQL*, *Q+E* is not designed for developing customized, menu-driven *Windows* applications to hand off to executives or nontechnical end users. *Q+E* offers no menu-building feature, and its data entry forms capability has few customization options. However, *Q+E* finds its niche as a versatile querying tool that's especially recommended for users who need to link SQL and other data sources on one side with friendly *Windows* applications on the other.

With *Q+E*, you can easily set up complex SQL queries that open multiple data base tables in different windows. Here, two tables are joined in a third window (at bottom) that combines information about several company departments and their employees.

EMPNO	ENAME	JOB	MGR	HIREDATE
1	7369 SMITH	CLERK		
2	7499 ALLEN	SALESMAN		
3	7521 WARD	SALESMAN		
4	7566 JONES	MANAGER		
5	7654 MARTIN	SALESMAN		
6	7698 BLAKE	MANAGER		
7	7782 CLARK	MANAGER		
8	7788 SCOTT	ANALYST		
9	7839 KING	PRESIDENT		11/17/81 12
10	7844 TURNER	SALESMAN	7698	9/8/81 12:01

DNAME	DEPTNO	LOC
1 ACCOUNTING	10	NEW YORK
2 RESEARCH	20	DALLAS
3 SALES	30	CHICAGO
4 OPERATIONS	40	BOSTON

DNAME	SCOTT.DEPT2	LOC	EMPNO	ENAME	JOB	MGR
1 ACCOUNTING		10 NEW YORK	7782	CLARK	MANAGER	7839
2			7839	KING	PRESIDENT	
3			7934	MILLER	CLERK	7782
4 RESEARCH		20 DALLAS	7369	SMITH	CLERK	7902
5			7876	BLAKE	CLERK	7788
6			7902	FORD	ANALYST	7566
7			7788	SCOTT	ANALYST	7566
8			7566	JONES	MANAGER	7839
9 SALES		30 CHICAGO	7499	ALLEN	SALESMAN	7698
10			7698	BLAKE	MANAGER	7839
11			7654	MARTIN	SALESMAN	7698
12			7788	JAMES	CLERK	7698

WHERE TO BUY**Q+E 2.6**

Pioneer Software
5540 Centerview Dr. #324
Raleigh, NC 27606
800/876-3101, 919/859-3334 (fox)
LIST PRICE: standard edition \$199, server edition \$299, five-user server edition \$999;
Microsoft version included with Excel 3.0
REQUIREMENTS: 1.5MB RAM, Windows 3.0, hard disk
TECHNICAL SUPPORT: unlimited, no toll-free number, M-F 9-5
OTHER SUPPORT: paid support plans available; BBS for paid support plans
Reader service no. 672



PerFORM PRO FOR FORMS THAT FOLLOW FUNCTIONS

You use forms to capture and communicate information. You own PCs for the same reason. So why aren't your forms computerized?

Sure, you can create forms in many word processing packages. You can even design attractive forms using desktop publishing. But you need a total solution. You need the leader in forms processing software. You need PerFORM PRO.

PerFORM PRO lets you implement a complete forms management system immediately.

Or you can start with just the basics, using tools created specifically for form designing. Then expand to electronic form filling when you're ready.

You can add complementary Delrina products. Soon, you'll be able to automatically turn paper forms into PerFORM forms. Right now, you can use WinFax to fax completed forms directly from any Windows application.

Wherever you start, you'll save money. For every \$1 spent printing forms, the average corporation spends another \$60 designing, updating, warehousing, distributing and filling them.

You'll save time too. A leading North American financial institution cut their form-filling time in half when they switched from paper forms to PerFORM forms.

SIMPLE DESIGNING

PerFORM Pro's WYSIWYG "Designer" software runs under Windows 3.0. And

it makes form designing easier and more complete than any of the old ways. You'll find an array of tools. A wide choice of typefaces. Over 100 sample forms. And the ability to add graphics like your company's logo. For security, PerFORM PRO's powerful electronic signatures can secure data. And the final form design can also be locked.

EVEN SIMPLER FILLING

PerFORM PRO "Filler" runs stand-alone or networked. And takes the frustration out of form-filling, making it fast, easy and error-free. Multi-platform solutions enable any IBM PC user to take advantage of PerFORM PRO's powerful filling features. Like validation, database lookup, indexing and over 65 functions for automatic math calculations, "if... then" statements, date functions, financial calculations and more.

PerFORM PRO will read and write to dBASE or ASCII files, sharing common information across several forms. You can create dBASE indexes to help you find data. And you can group related forms together so that common information only has to be entered once. You'll save time with fast printing too, especially on HP LaserJets.

If you're not completely satisfied, return the entire package for a full refund within 60 days.

Ask your dealer about PerFORM PRO today. Or call our toll-free number for more information on the complete forms management solution.

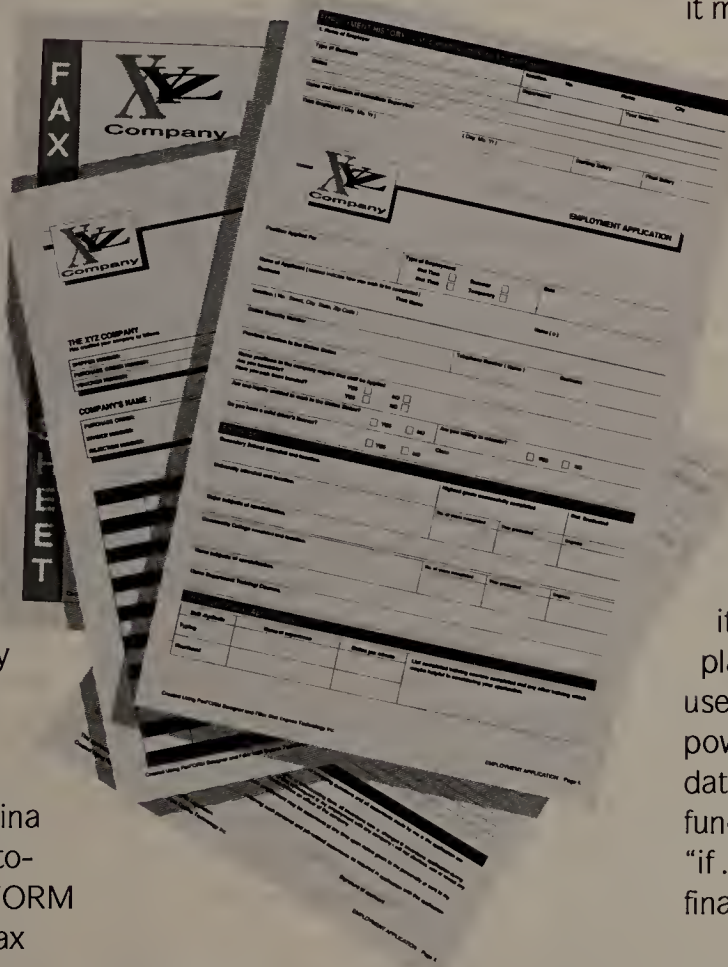

PerFORM PRO



DELRINA
TECHNOLOGY INC.

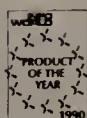

FOR MORE
INFORMATION,
CALL TOLL-FREE



1-800-268-6082

Circle 61 on reader service card

Access SQL

Data Access Software

Review

Robert M. Gentry
& Robert C. Bolt

At a busy mail-order company in New York, the linchpin of the entire business is a customer information data base. In the sales department, telephone sales reps enter each customer's name, address, and order information into an electronic form, automatically updating the central data base. This information is accessible in the executive office, where a top manager clicks on a custom-designed menu option that delivers an up-to-the-minute list of the top ten customers. Meanwhile, somewhere in Albuquerque, a sales manager uses a custom laptop application to tap into the same data base and update it with that day's sales leads.

Access SQL allows this kind of enterprisewide access to a central data base. *Access SQL* is a front end that can act as a stand-alone data base management system, thanks to a built-in copy of Gupta's *SQLBase* server engine. The pro-

gram allows users to view, manipulate, and update information in a SQL data base and, unlike *Forest & Trees* and *Q+E*, it's geared to organizations that want to create custom applications for end users.

Like *Q+E*, *Access SQL* allows you to create complex SQL statements merely by pointing and clicking on standard *Windows* menus, buttons, or boxes, making it easy for managers with little training to perform ad hoc queries, view and modify tables, and access reports.

Taking full advantage of the product, however, requires a developer's services. But instead of requiring the developer to use a programming language, *Access SQL* is designed specifically as a forms development environment for creating applications such as the telephone salesperson's order entry tool.

The first step in designing a form is creating queries, which define what data will be accessible to the user. Queries can all be defined in advance or

created individually and linked to different sections of a form or other application. *Access SQL* helps out with a default form layout, or you can customize the form with options like buttons, pop-up pick lists, and drop-down menus.

Although *Access SQL* has no graphing capabilities, its excellent report generation allows users to pour in data from numerous sources and to use calculated fields. Like *InfoAlliance*, *Access SQL* offers sophisticated data security, sure to appeal to administrators. Features include assignable passwords and privilege levels, automatic logging of data base transactions, and backup utilities.

All this power comes at a price. *Access SQL* costs \$695 for the single-user version, which allows developers to build applications without being on a network, and \$1595 for a network version that supports four developers. Run-time versions are extra, as are Gupta gateway products that provide back-end communication with *Oracle Server* and IBM's *DB2*. An interface for Microsoft's *SQL Server* is under development.

Unlike *Forest & Trees*, *Access SQL* is designed for businesses dependent on a data base that is regularly accessed and updated by several departments. Its unique benefit, compared with a tool like *Q+E*, is its ability to create customized applications, providing users with push-button access to the data they need to get the job done.

With *Access SQL*, it's easy to build a SQL query just by pointing and clicking. The query appears in the top window; the results (in this case, all professors who earn more than \$40,000 annually) appear below.

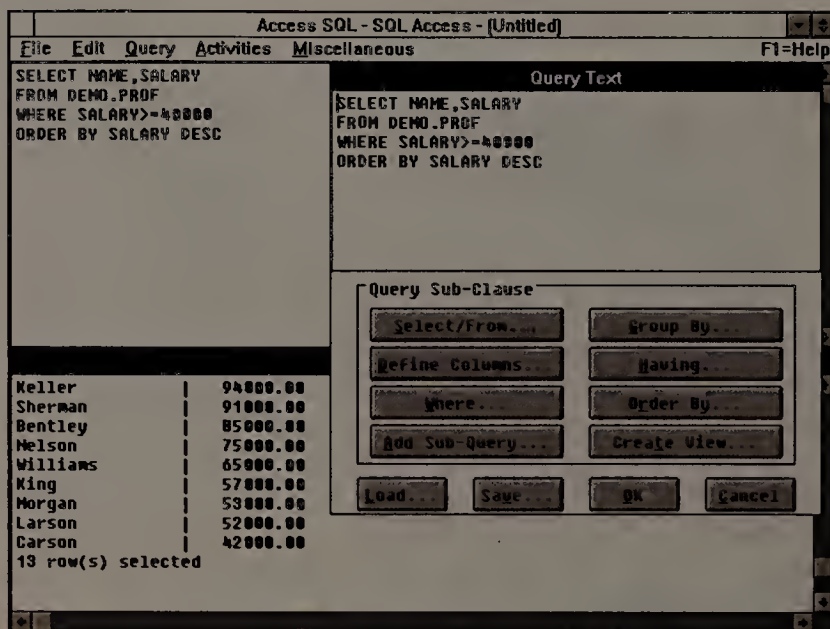

WHERE TO BUY

Access SQL 1.20

Software Products Int'l
9920 Pacific Heights Blvd.
San Diego, CA 92121
800/937-4774, 619/450-1921 (fax)
REQUIREMENTS: 640K, Windows 3.0, hard disk; runs on any NetBIOS-compatible network
LIST PRICE: single-user version \$695, four-user network version \$1595, four-user run-time \$545
TECHNICAL SUPPORT: 90 days free, toll-free number, M-F 8-5
OTHER SUPPORT: BBS, paid support plans available
Reader service no. 671

TI microLaser™ printers open new windows.

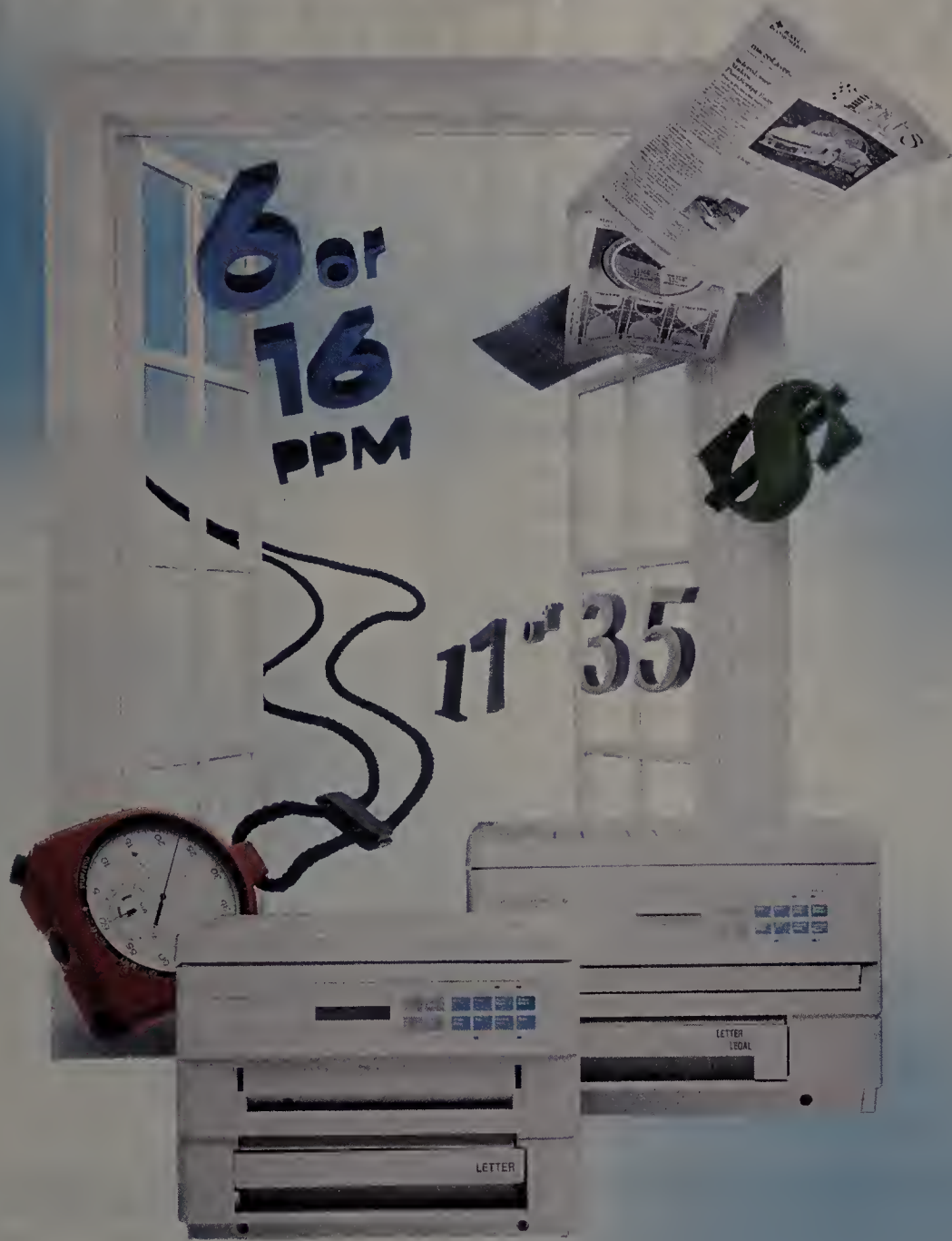

With powerful fonts and graphics, ease of use and economy.

By now you've heard how fast and easy Microsoft® Windows™ makes it to tap all that PC power you've got on your desk.

Well now there's an affordable, easy way to put that power on paper — microLaser from Texas Instruments.

Right out of the box, microLaser comes with what you need to print the razzle-dazzle pages of text and graphics you've dreamed of creating.

Just plug it in and go.

That's because microLaser PS models come with the Adobe® PostScript® language



and the memory it takes to use it. Plus you get your choice of either 17 or 35 scalable fonts, starting at just \$1,999.*

When it comes to print speed, microLaser zips along at 6 ppm. If you need a shared printer solution, turn to its cousin, microLaser XL. This workhorse gallops at a formidable 16 ppm.

If all that isn't enough, just look at what else you get with microLaser. It's the smallest printer in its class. It handles more paper and envelopes in more ways. And it supports more than 4,000



software packages, including your Windows applications.

So when you add it all up,

you'll understand why MacUser needs the power, convenience and economy of microLaser. Let microLaser open new windows for you.

For the name of the nearest dealer, call **1-800-527-3500.**

The microLaser PS17 has earned the 1990 PC World Best Buy award; microLaser PS35 has earned the 1990 InfoWorld Excellent Value award and 4½ mice from MacUser, October 1990.



**TEXAS
INSTRUMENTS**

* TI suggested retail price. (Dealers' prices may vary.) microLaser is a trademark of Texas Instruments Incorporated. Adobe, PostScript and the PostScript Logo are registered trademarks of Adobe Systems, Inc. Microsoft is a registered trademark and Windows is a trademark of Microsoft Corporation. ©1991 TI 71816

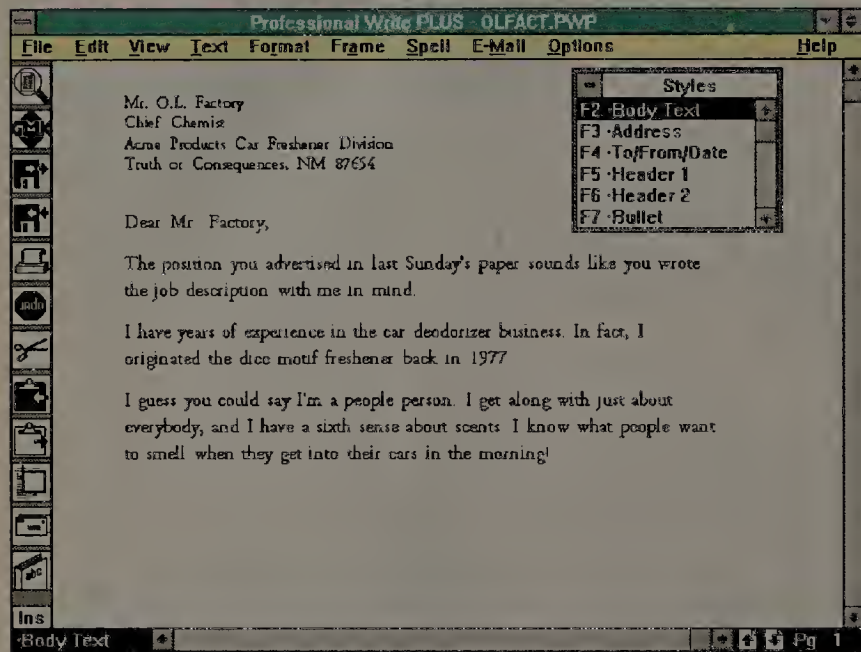
Now there's a word processor more on their minds than

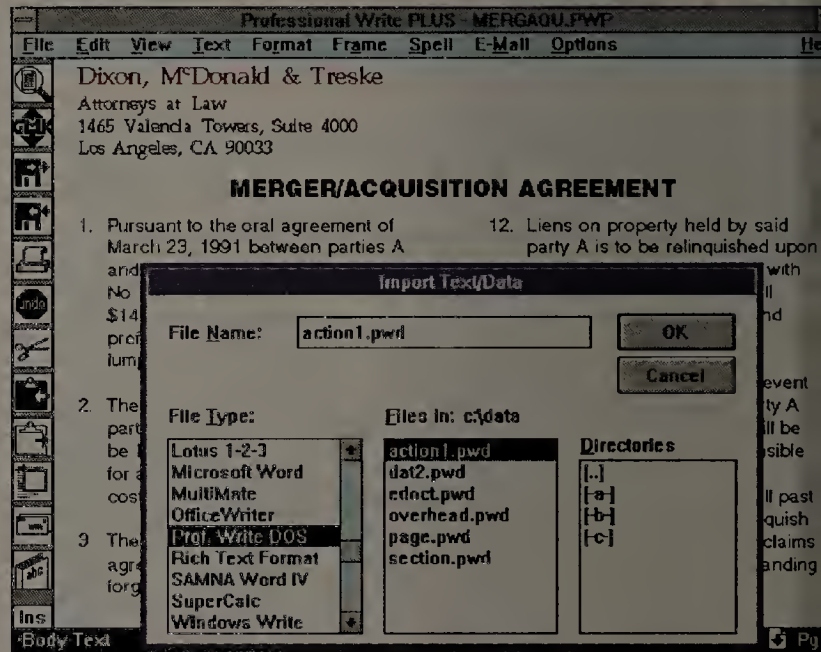

Professional Write PLUS lets busy people handle routine tasks easily. And offers a choice of 24 ready-made style templates.



It makes nearly everybody compatible, at least as far as sharing data is concerned.

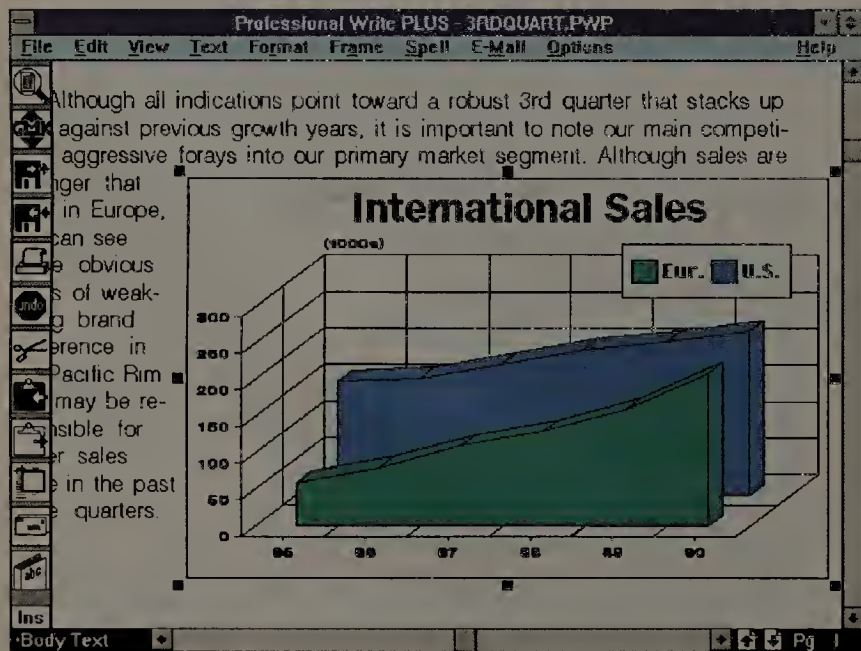

Importing graphics is a snap. And the same can be said for moving and rescaling them.

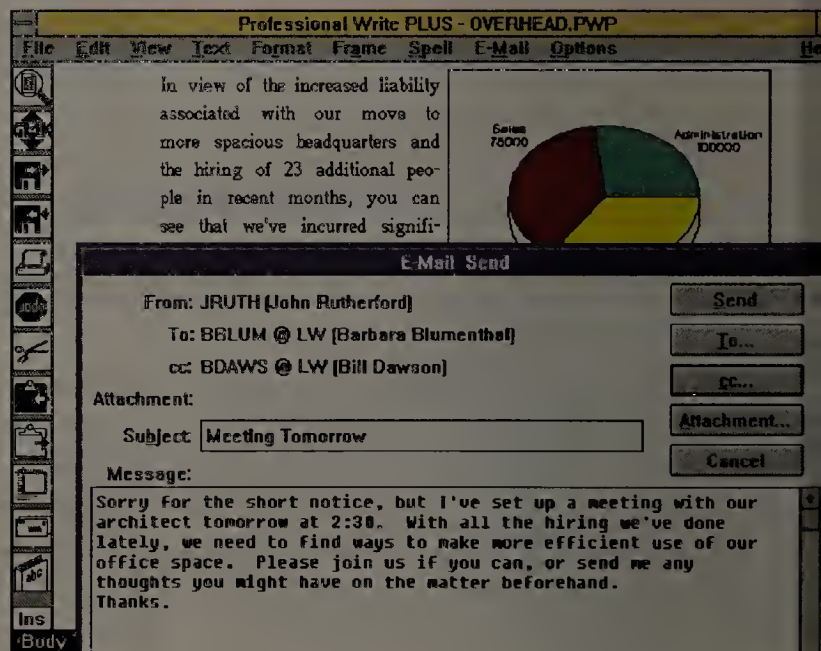

Its E-mail front end lets you send and receive messages and data without exiting from your document.

Introducing a new concept in Windows word processing, Professional

Processor for people who have in word processing.

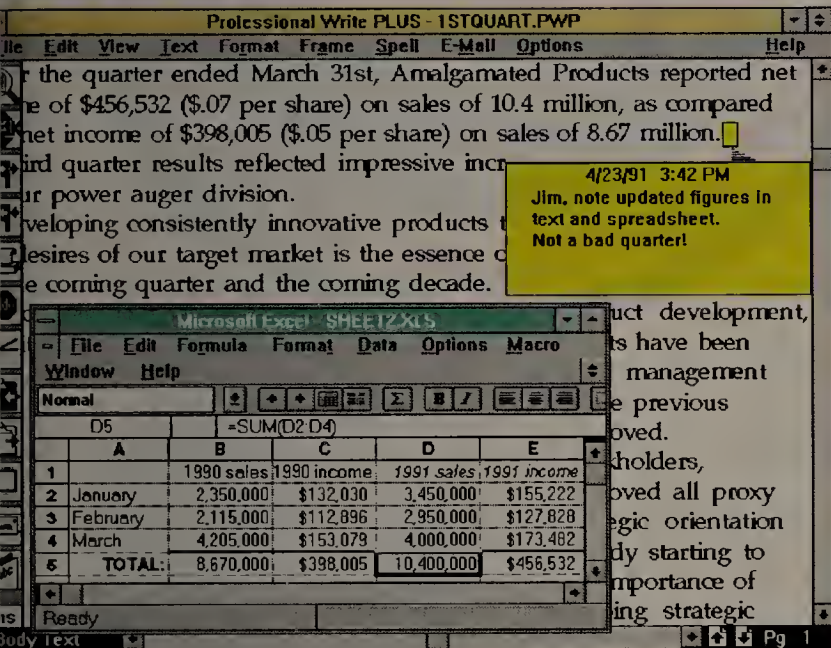

Updating figures and text from other Windows applications is automatic via DDE links.

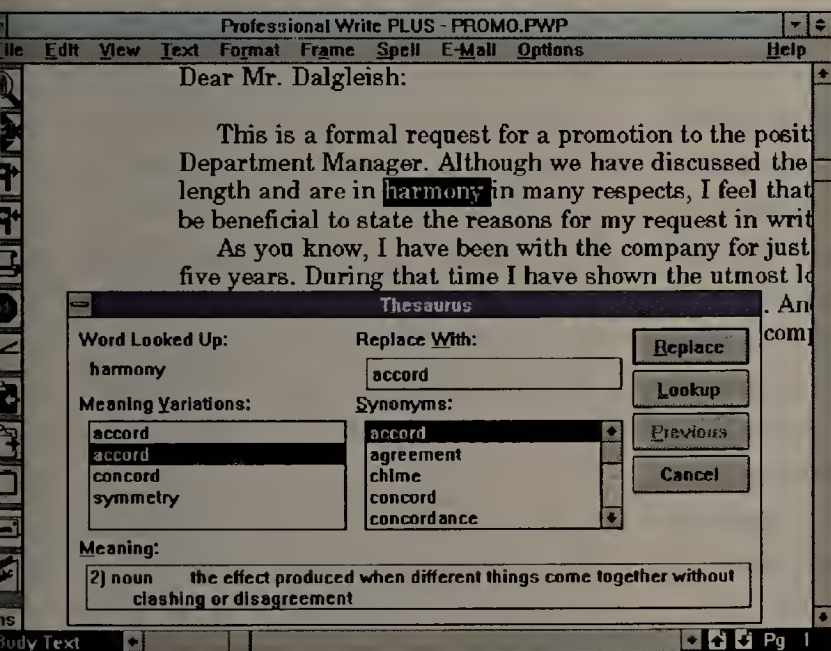

And Professional Write PLUS even helps with grammar, spelling and word choice. So you always look your persuasive best.

Business professionals have more pressing concerns than learning a word processor. And better things to do with their time than studying a manual.

For them, there's no better Windows™ word processor than Professional Write PLUS® from Software Publishing Corporation.

It's easy to learn. So they can get up to speed fast. And get cracking on everything from minor memos to major proposals. On paper or on E-mail.

And it's so in touch with users' needs, it won the PC Week Shoot-Out for Document Processing. Proving better than WordPerfect® 5.1 and Microsoft Word® for Windows. Not to mention earning InfoWorld's Recommended Product Seal.

So call for a free trial disk today. And discover a better way to help business professionals take care of the really important stuff.

SPC SOFTWARE PUBLISHING CORPORATION

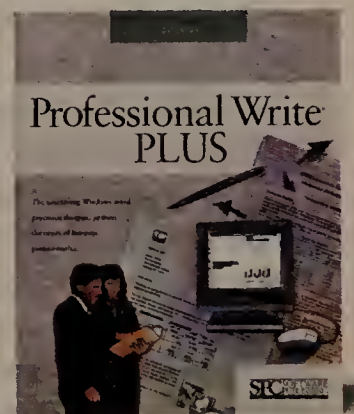

Write PLUS. Call 1-800-336-8360, Operator 513, for a free trial disk.

WordPerfect is a registered trademark of WordPerfect Corporation. ©1991 Software Publishing Corporation. All rights reserved.

Windows

Road Test

Alice LaPlante

3.0



Users are the ultimate consumer advocates. In a new PC World series, users report from the trenches on their real-life experiences—this month with Windows 3.0.

First impressions *aren't* everything.

Only after living with a product for several months do you begin to get a real sense of its pluses and minuses and to know whether it's going to meet your needs. That's why we're instituting a new feature—the *PC World* Road Test. Each month, we'll put several users in the reviewer's seat and feature their first-person assessments of hardware and software products.

Our road testers bring to their evaluation a level of use and experience not generally found in magazine reviews. They've all used the product day in and day out—learning shortcuts, identifying strengths and weaknesses, and discovering firsthand whether it works for them. Each month, you'll be able to learn what a product is *really* like from people whose productivity and effectiveness depend on it—and you can make informed buying decisions as a result.

This month's Road Test reports the experiences and assessments of six

users of *Windows 3.0*. We've selected a cross section of users who work in different professions and represent various levels of PC expertise.

Only two features got a fairly consistent review from users: the graphical user interface and the file manager. After years of experimentation, Microsoft seems to have figured out how to design an appealing and useful GUI. The same can't be said for the file manager, however, which received a barely passing grade from several of our road testers.

Read on to find out more about the features users love and the ones they can live without.

John Kirkpatrick

John is a longtime Macintosh user. He used Windows sparingly prior to 3.0's release. He uses his PC to write, edit, and format reports.

As a corporate operating environment, *Windows* is barely adequate. It's slow and cumbersome, and it doesn't

really do the things it's proclaimed to do. But *Windows* has its purposes: It introduces users to a quasigraphical environment, allows them to do rudimentary task switching, and prepares them for the more complex operating environments, such as OS/2, that are on the way.

Windows' graphical interface barely makes the grade. It's extremely slow and takes an extraordinary amount of overhead. It's a little more intuitive than DOS, but that's it.

The main reason I use *Windows* is because of its task-switching capability. But without the help of Quarterdeck's *QEMM-386 5.1*, this would be a much weaker feature, since *Windows* does such a poor job of managing its extended and expanded memory for DOS programs.

Mary Maki

Mary's been a Windows 3.0 user since June 1990. Her job duties include developing and producing internal documents such as newsletters, manuals, forms, and fliers.

Once you know *Windows'* limitations, you can probably get value out of it, but it didn't work for me. After using it for eight months, I gave up.

My main problem with *Windows* was how it worked—actually, didn't



Name: John Kirkpatrick
Title: PC specialist
Company: GDS Associates
 (electric utility consultants)
Hardware: 20-MHz 386, 4MB
 RAM, 100MB hard drive
Software: *Charisma, Designer,*
WordPerfect, 1-2-3



Name: Mary Maki
Position: Graphic specialist
Company: Bell Atlantic
Hardware: 16-MHz 386, 12MB
 RAM, 40MB hard drive
Software: *Ventura Publisher,*
Designer, PageMaker



Name: Munir Mandivawalla
Title: Teacher/graduate student
Organization: Claremont
 Graduate School/Cal Poly
 Technical Institute
Hardware: 25-MHz 386, 4MB
 RAM, 40MB hard drive
Software: *Word for Windows,*
Corel Draw, Excel

work—with *Ventura Publisher*. The PostScript driver didn't support the paper sizes I use with my Linotronic typesetter, and a number of *Ventura's* features weren't usable under *Windows*, even though they worked fine under *GEM*.

The multitasking aspect of *Windows* isn't a big improvement over DOS. I rarely got the cursor back while something was processing in the background. The file management system also needs work. It's so confusing that for a long time I thought I was doing something wrong. Then I realized it was just poorly implemented.

For me, *Windows's* strongest feature was being able to cut and paste between applications. But I can't say *Windows* improved my productivity. I lost a lot of time because of all the bugs.

Munir Mandivawalla

Munir became a "regular" Windows user after the introduction of version 3.0. He uses his PC primarily for word processing and for tracking and tabulating student grades.

Windows is still a fairly primitive environment, but with the advent of 3.0 it's usable for most business purposes.

The graphical interface is getting there, but it needs to be more object oriented—like Hewlett-Packard's *NewWave*. I'd like to be able to put together documents from different applications and interact with them directly.

Under *Windows* there'll always be some applications that won't work the way others do. I guess we'll just have to live with the inconsistencies.

The cut-and-paste feature is fine for anything that has to do with text. But for graphics, some formats make it impossible to do smooth cuts and pastes.

A lot of people have said that their productivity increased tremendously because of *Windows*. I'd put a different spin on it: My effectiveness has increased. The things I now do, using *Windows*, I just wouldn't have attempted before.

Mark McNally

Mark has been using Windows 3.0 since it debuted last spring. He uses his PC primarily to manage his investment portfolio.

Right from the beginning, I was amazed at how easy it was to maneuver and navigate through *Windows*. I was able to pick up *Word for Windows* and *Excel* almost immediately and start cutting and pasting text between them.

The WYSIWYG feature is especially important. Before, I had to print things several times before I got them right. Now, with Print Preview, I can see how things are going to turn out before I print them.

But DDE is probably the key feature that *Windows* offers. I used DDE to write a program that allows *Crosstalk for Windows* to call up Dow Jones News/Retrieval, cut out the stock quotes I need, and automatically download them into an *Excel* spreadsheet. Then, *Excel* performs the necessary calculations and creates a chart, which is there waiting for me in the morning.

My biggest complaint? There's not enough information about DDE. I had to figure it out and teach it to myself. It took a lot of trial and error, which kind of wasted my time. In the end, however, it was worth it.

Sharyn Pendleton

Sharyn never used a PC before Windows 3.0 was introduced. She uses PageMaker to create a calendar of classes offered by the city of San Carlos.

I like *Windows*, but I needed a lot of training to get where I am today—and I still don't understand all the features. I'm still a little intimidated. Anyone who says you can use *Windows* immediately even if you don't know anything about PCs is dead wrong! Still, *Windows* makes using the computer less intimidating. It lets me do my job and insulates me from having to understand the technical stuff.

The cut-and-paste feature is my fa-



PAM ADAMS

Name: Mark McNally
Title: Store manager
Hardware: 20-MHz 286, 4MB RAM, 40MB hard drive
Software: Word for Windows, Excel, Crosstalk for Windows



BRIAN DEVON

Name: Sharyn Pendleton
Title: Administrative clerk
Organization: City of San Carlos, California
Hardware: 386SX, 2MB RAM, 40MB hard drive
Software: Word for Windows, PageMaker, Excel, Arts & Letters



JON READ

Name: Bob Raeside
Title: Administrator
Company: Rockwell International
Hardware: 20-MHz 386, 4MB RAM, 110MB hard drive
Software: Word for Windows, PageMaker, Corel Draw, Excel, 1-2-3, Freelance Plus

avorite. It's a real improvement over actually cutting and pasting strips of paper that come out of a printer! But the WYSIWYG feature isn't perfect. We bought a PostScript cartridge for our LaserJet, and the document isn't coming out the way it looks on the screen. So I have to print things out over and over again until I get it right.

I haven't had the nerve to try the multitasking feature yet. I'm nervous I'll lose what I'm working on. I've come a long way—I used to be afraid to touch anything on the keyboard.

Bob Raeside

Bob's been using Windows since version 2.0 was released, and switched to version 3.0 last spring. He uses his PC to write reports, review documents, and track budgets.

The difference between working in a Windows and a non-Windows environment is like night and day. The obvious strong point is that Windows applications all look and feel the same. In just a few minutes you can get up to speed on a program you've never seen before.

But multitasking is really why you

buy Windows. I'm constantly going back and forth between applications—from a graphics package to a spreadsheet and back to E-mail.

The cut-and-paste feature just doesn't hack it in non-Windows applications, though. It's not a smooth operation. I don't care for the file manager, either. It's cumbersome, and nothing follows intuitively. There's also no easy way out of the thing. I use Norton Commander instead.

Making the switch to an entirely Windows environment isn't easy. I consider myself fairly adaptable, but I just couldn't give up 1-2-3. I think until more Windows packages are available, a lot of users won't want to switch: It means they have to relearn everything. ●

Sharon Fisher is a San Francisco-based freelance writer specializing in data communications. Robert M. Gentry is vice president and Robert C. Bolt is president of Database Server Systems, a consulting company in South San Francisco that specializes in data base servers and client-server technology. Alice LaPlante is a freelance writer in Palo Alto, California.



Windows 3.0 Report Card

Features	John Kirkpatrick	Mary Maki	Munir Mandiwalla	Mark McNally	Sharyn Pendleton	Bob Raeside
Graphical interface	C+	B-	B	A	B	B
Consistency between applications	D	B	A	A	B	A
Ability to cut and paste	C	A	C	A	A	C
WYSIWYG	B	C	B	A	C	B+
DDE	B+	*	B	A	*	*
Multitasking	A	C	A	A	*	A
File management system	C-	C-	B	B	B	D-
Overall	B	C	A	A	B	B

*User has not fully tested or used feature

The Drudgery Of Image Processing Just Went Out The Window

Automatic Filters remove spots, sharpen resolution, adjust brightness and contrast, blend, and equalize scanned images.

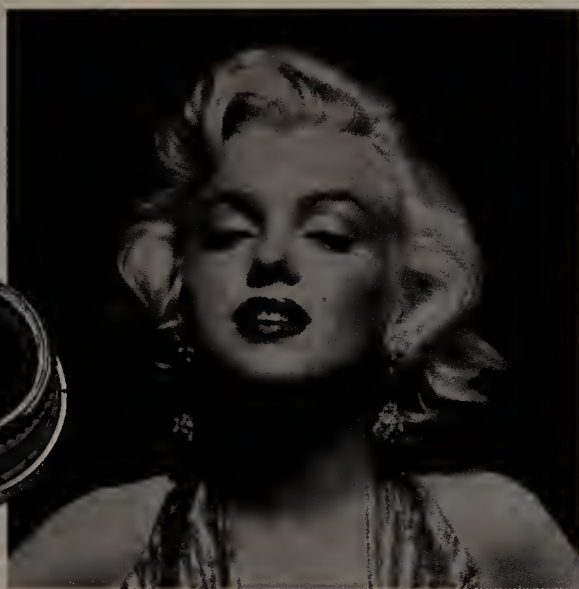

Zoom In and Zoom Out in multiple levels while accessing all tools, retouching features, and special effects.

Special Effects let you tint, smudge, add patterns and gradient fills, create 3-D effects, style text, give images a mosaic look, simulate "motion blur," and more.



Create and edit images with up to 16.7 million colors or 256 shades of gray.

With Publisher's Paintbrush®—ZSoft's new, top-of-the-line image processing program, custom built for Windows™ 3.0. The program designed for professionals. Integrating ZSoft's award-winning paint tools, complete scanner control, plus the most powerful, sophisticated image processing capabilities available. All in one easy-to-use application.

Complete image control is yours: multiple level zooms let you move from precise editing...to larger than screen size images... while accessing all tools. Automatic filters amplify detail and save hours of retouching.

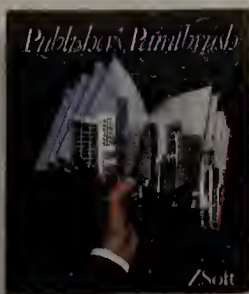

Gray scale calibration ensures realistic output. View multiple versions of images in multiple windows for easy comparison while retouching, cloning, and cutting-and-pasting. Extensive file support (PCX, TIF, GIF, BMP, EPS*, TGA and more) guarantees compatibility.

Enhance photos and create powerful visual effects for brochures, newsletters, presentations, and more. With Publisher's Paintbrush, creativity knows no limits. For more information about the image processing program for professionals, call us at (404) 428-0008.

ZSoft
CORPORATION

To update, send \$75 (add \$4.90 shipping/handling) and your original Publisher's Paintbrush program disk to: ZSoft Update, Dept. WX, 450 Franklin Rd., Suite 100, Marietta, GA 30067. Specify 5.25" or 3.5" disk. GA residents add (3%) sales tax. Canadian customers add \$15.90 for air shipping. Outside N. America, add \$15.90 for surface shipping, \$24.90 via air. Payment in U.S. funds by check, money order, VISA, MC or AX. Upgrades from all ZSoft PAINT programs available, call for details. (404) 428-0008.

© 1991 ZSoft Corporation

*EPS file support is write only. System Requirements: Microsoft Windows™ 3.0 or higher, Windows-capable computer with a hard disk, display adapter and drawing device. Publisher's Paintbrush is a registered trademark of ZSoft Corporation. Windows is a trademark of Microsoft Corporation. Photo licensed by The Roger Richman Agency, Inc., Beverly Hills, CA.

Circle 320 on reader service card

The Windows Shopper's Guide.

- Product Directory
- Feature Articles
- Reviews and more!

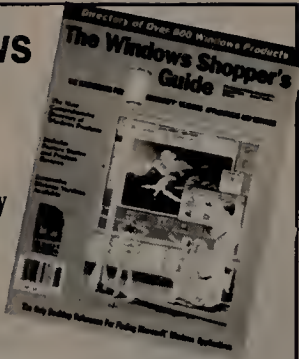

The most comprehensive directory of applications currently available for Microsoft Windows*. 224 pages packed with product listings and exciting articles.

A Publication of WHITEFOX™ COMMUNICATIONS, INC.

Only \$19.95 (U.S. Orders)
Plus \$3.50 Shipping & Handling

Order Today

1-800-669-5612

(Canada add \$10.00
Europe add \$12.00)

Visa • Mastercard

Price Subject to Change

*Microsoft is a registered trademark and Microsoft Windows is a Trademark of Microsoft.

Circle 349 on reader service card

Nuclear Computing

File ShareWare Public Domain Help

Windows ShareWare

• Applications • Utilities • ToolBook •
• Games • Icons • Sounds • Fonts •

OVER 350 PROGRAMS!

Version 3.0 specific-compatible

Call or write today for free catalog, or send \$7.50 for postage & handling to receive:

Six programs and 2,000 icons FREE!

NUCLEAR COMPUTING

P.O. Box 15757, Dept. 159
N. Hollywood, CA 91615
(818) 764-5374

Circle 334 on reader service card

PC WORLD

Find out
what's in it
for you.

501 Second Street
San Francisco, CA 94107

NEW!

ANNOUNCING

WINFAX PRO

Only \$19.95

Send and Receive faxes while working in Windows 3

“WINFAX is one of those small software miracles that does one thing really well: It makes sending a fax as easy as printing from your printer.”

DELRIINA
TECHNOLOGY INC.

To find out more call **1-800-268-6082**

Alfred Poor
PC Magazine
February 26, 1991

- ▶ Send faxes from any Windows application unattended using WINFAX PRO's programmable phone books
- ▶ Receive faxes in background while you work in Windows
- ▶ Send a broadcast fax to an entire group with a single command
- ▶ Print plain paper faxes from your printer. No more curly fax paper.
- ▶ Fully customizable cover pages

Circle 347 on reader service card

Linear programming optimization

MINI-MAX™

for Windows 3.0
\$395



NEW!

TREUHAND
OF TEXAS

POB 32, Kingsville, TX 78364
512 595 7810, Fax 512 595 0446

Circle 348 on reader service card

Mechanical Requirements:

Camera Ready Art

On ads without halftones or screens, please send a Velox or PMT (stat). For ads with halftones or screens, we require that you send us film. This assures you the highest quality reproduction of your halftones. All film needs to be right reading, emulsion down negatives.

Negatives

Right reading, emulsion side down. 133-line screen preferred by printer, 120-150 acceptable. Density of tone should not exceed the following: B&W 80%.

Printing process—Web offset

Binding method—Perfect

Note: Ads to be black & white only.

Maintain your momentum in the Windows Marketplace. Advertise in the Quarterly Windows Catalog.

Call Sandra Wade or Duane Hampson at PC WORLD for Details

800-435-7766

In CA:

800-435-7760

PC WORLD

From financial analysis and publishing software to pointing devices and scanner systems, *PC WORLD WINDOWS Catalog* creates the perfect selling environment for all your Windows products. This special section of inexpensive 1/8 page ads allows buyers immediate access to the windows products they have been looking for, to quickly compare specs and prices and then to place their order.

— Coming soon to a department under you. —

NIGHT OF THE LIVING DEADLINES.



Project Calendar™ presents your schedules in a familiar calendar format—and that's just one of the many On Target reports.

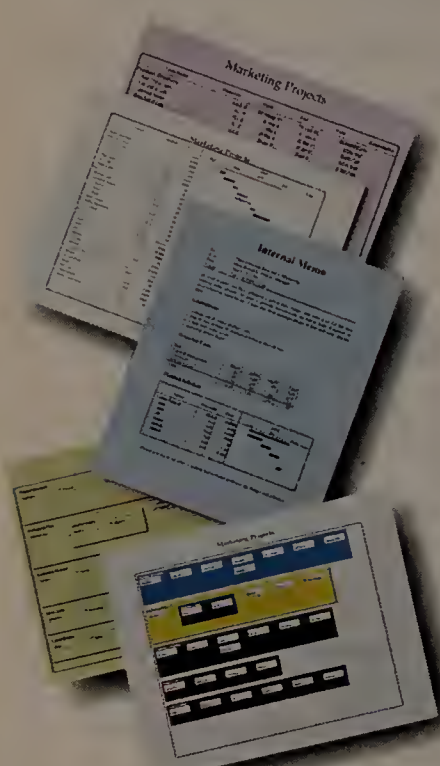

On Target creates a number of different reports. You can also copy graphics into other Windows applications.



With On Target, everyone is clear about their responsibilities—so your team can work together more effectively.

Circle 272 on reader service card

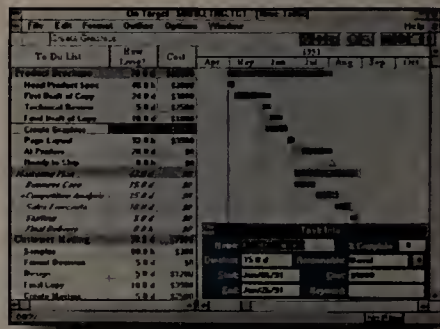

On Target is designed specifically for Windows™ 3.0. Its graphical user interface, familiar spreadsheet format, and full color WYSIWYG graphics make project planning easy.

It's 2:30 a.m. Do you know where your projects stand? Now you can avoid those horrifying all-nighters with On Target™—the Windows 3.0 project planner from Symantec.

On Target is the easiest way to keep tabs on virtually all your projects at once. It's the most appropriate way, short of formal "project management," to manage all your schedules and deadlines.

On Target instantly converts your projects into a variety of detailed schedules, charts and graphs. Just enter your schedules into the familiar spreadsheet interface, and choose your own colors, fonts, and display format. On Target does all the rest.

On Target's *Schedule Assistant*™ guides you logically through the planning process. It even comes with *Starter Schedules* to help you start planning right away. So if your workload has become a nightmare, rest easy. It's all in a day's work with On Target.

Call now for a free demo disk.*



1-800-228-4122 Ext. 303-W

SYMANTEC.

*Demo disk available in US and Canada only. Outside the US, call (408) 253-9600. © 1991 Symantec Corporation. On Target, Project Calendar and Schedule Assistant are trademarks of Symantec Corp. All other products or brand names listed are trademarks or registered trademarks of their respective holders.

YOUR

PowerBASE**
PCWORLD



FREE

PowerBASE**
PCWORLD



PowerBase** DISK

PowerBASE**
PCWORLD



Get a free disk just for subscribing to PC World. Tap into 42 of our readers' all-time favorite utilities from "Star-Dot-Star," PC World's monthly How-To forum.

YES! Please enter my subscription to PC World for 12 monthly issues at the preferred rate of only \$19.97. I'll save 33% off the regular subscription rate and 58% off the annual newsstand price. I'll also receive my PowerBase Disk absolutely free!**

NAME _____

COMPANY _____

ADDRESS _____

CITY / STATE / ZIP _____

Annual newsstand price, \$47.40; basic subscription rate, \$29.90. Please allow 6 to 8 weeks for delivery of your first issue. Offer good in the U.S. only.

PC WORLD

4FW98

You get fast, easy new tricks for WordPerfect, WordStar, DOS, Lotus 1-2-3, dBase, Turbo Pascal, Turbo C, Basic and more!

YES! Please enter my subscription to PC World for 12 monthly issues at the preferred rate of only \$19.97. I'll save 33% off the regular subscription rate and 58% off the annual newsstand price. I'll also receive my PowerBase Disk absolutely free!**

NAME _____

COMPANY _____

ADDRESS _____

CITY / STATE / ZIP _____

Annual newsstand price, \$47.40; basic subscription rate, \$29.90. Please allow 6 to 8 weeks for delivery of your first issue. Offer good in the U.S. only.

PC WORLD

4FW98

These 42 time-saving utilities are not available in any store, but they can be yours—FREE—just for subscribing to PC World.

YES! Please enter my subscription to PC World for 12 monthly issues at the preferred rate of only \$19.97. I'll save 33% off the regular subscription rate and 58% off the annual newsstand price. I'll also receive my PowerBase Disk absolutely free!**

NAME _____

COMPANY _____

ADDRESS _____

CITY / STATE / ZIP _____

Annual newsstand price, \$47.40; basic subscription rate, \$29.90. Please allow 6 to 8 weeks for delivery of your first issue. Offer good in the U.S. only.

PC WORLD

4FW98

PowerBase ** diskette is offered solely by PC World Magazine. It should not be confused with 'power-base,' which is relational database software offered by Compuware Corporation.

Attention:
Recipient is entitled to
42 FREE utilities plus
33% off
the regular
subscription rate.



BUSINESS REPLY MAIL

FIRST CLASS PERMIT NO. 1262 BOULDER, CO

POSTAGE WILL BE PAID BY ADDRESSEE

PC WORLD

Subscription Department
P.O. Box 51833
Boulder, Colorado 80321-1833



NO POSTAGE
NECESSARY
IF MAILED
IN THE
UNITED STATES

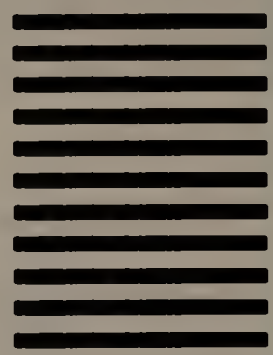

Attention:
Recipient is entitled to
42 FREE utilities plus
33% off
the regular
subscription rate.



BUSINESS REPLY MAIL

FIRST CLASS PERMIT NO. 1262 BOULDER, CO

POSTAGE WILL BE PAID BY ADDRESSEE

PC WORLD

Subscription Department
P.O. Box 51833
Boulder, Colorado 80321-1833



NO POSTAGE
NECESSARY
IF MAILED
IN THE
UNITED STATES

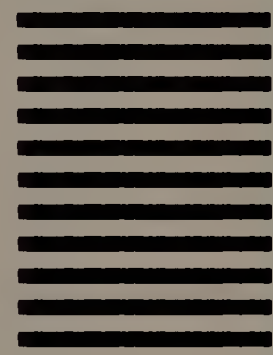

Attention:
Recipient is entitled to
42 FREE utilities plus
33% off
the regular
subscription rate.



BUSINESS REPLY MAIL

FIRST CLASS PERMIT NO. 1262 BOULDER, CO

POSTAGE WILL BE PAID BY ADDRESSEE

PC WORLD

Subscription Department
P.O. Box 51833
Boulder, Colorado 80321-1833



NO POSTAGE
NECESSARY
IF MAILED
IN THE
UNITED STATES

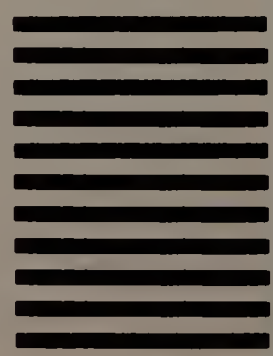

You get
more
out of it
because
we put
more
into it

You get more out of your computer with PC World. Because every issue is crammed with hands-on tutorials, free programs, product reviews, advice, tips and techniques designed to help you get the most out of your system.



**Receive the
PowerBase**
Disk FREE
when you
subscribe**

Now you can get this handy, menu-driven disk which contains the best of "Star-Dot-Star"—PC World's popular monthly forum for readers' how-to's—absolutely FREE when you subscribe to PC World. Your disk contains invaluable time-and work-saving macros and utilities for such popular programs as WordPerfect...WordStar...dBase...Lotus 1-2-3... and others.

To get your free disk, simply fill out the subscription card on the reverse side. Do it today!

Create Spreadsheet Reports With Style

Need to get a message across with numbers? Here's how to create effective spreadsheet reports using tried-and-true desktop publishing techniques.

John Walkenbach

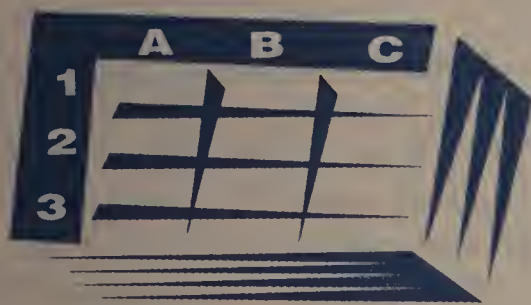

Spreadsheets

What happens when one of the new graphical spreadsheets joins forces with a laser printer? Depending on the user's knowledge of design, the result can be an attention-grabbing document—or a forbidding report likely to land in the “read it later” pile.

In the past, formatting a spreadsheet report involved little more than underlining titles and adding dollar signs and decimal places. Today, the process includes specifying fonts, attributes like italics, type size, borders, shading, and even clip art. This article presents basic

layout and design tips to help you produce visually effective reports—without overwhelming your reader.

► Clarity Is the Goal

The purpose of a spreadsheet report should be immediately obvious to anyone who looks at it. To avoid losing the reader in endless columns of numbers, you should support your message with titles and explanatory text, as shown in our first example.

To emphasize your main points, it's useful to set off headings and titles by shading them. But boldface the text so it's legible.

Although colored backgrounds and text might look great on screen, background colors are often converted to patterns of dots on a black-and-white printer. Run some tests before you spend too much time manipulating colors.

If your spreadsheet supports embedded images, you can use clip art—as

long as it really adds to your message. As shown in our second example, clip art can easily make a serious report look frivolous.

Another design flaw is putting too much information on a page. If you can, spread lengthy reports across several pages, and avoid the temptation to reduce margins to squeeze in a few extra columns or rows.

On the other hand, you don't want to push only a few lines onto a second page. The Print to Fit features in *Quattro Pro* and *1-2-3* can help: They squeeze your report by using smaller fonts. In *Quattro Pro 3.0*, you can accomplish this by selecting */Print* followed by *Print to fit*. In *1-2-3*, release 2.3, use *:Print Layout Compression Automatic*.

► Working With Fonts

It's only natural to want to get the most out of your new PostScript printer or font cartridge by using multiple type styles. But for readability, you should

The Good, the Bad, and the Ugly

Loan Amortization Schedule

Prepared for: Bill and Mary Higgins
July 13, 1991

This amortization schedule shows the amount of each monthly payment that is applied to interest and principal for the first five years. It is based on the following assumptions:

Purchase Price.....	\$195,000
Down Payment.....	\$40,000
Loan Amount.....	\$155,000
Interest Rate.....	12.50%
Term (in months).....	360

Month	Payment Amount	Paid to Interest	Paid to Principal	New Balance
1	\$1,654	\$1,614	\$40	\$154,960
2	1,654	1,614	40	154,920
3	1,654	1,613	41	154,879
4	1,654	1,613	41	154,838
5	1,654	1,612	42	154,796
6	1,654	1,612	42	154,754
7	1,654	1,612	42	154,712
8	1,654	1,611	43	154,669
9	1,654	1,611	43	154,626
10	1,654	1,610	44	154,582
11	1,654	1,610	44	154,538
12	1,654	1,609	45	154,493
13	1,654	1,609	45	154,448
14	1,654	1,609	46	154,402

* Loan Amortization Schedule *

Price:	\$195,000.00	
Down Payment:	\$40,000.00	
Loan Amount:	\$155,000.00	
Interest Rate:	12.5000%	
Term:	360 months	

Period	Payment Amount	Paid to Interest	Paid to Princ.	New Balance
1	\$1,654.25	\$1,614.58	\$39.67	\$154,960.33
2	\$1,654.25	\$1,614.17	\$40.08	\$154,920.25
3	\$1,654.25	\$1,613.75	\$40.50	\$154,879.76
4	\$1,654.25	\$1,613.33	\$40.92	\$154,838.84
5	654.25	\$1,612.90	\$41.34	\$154,797.49

Loan Amortization Schedule

Price: \$195,000.00
Down Payment: \$40,000.00
Loan Amount: \$155,000.00
Interest Rate: 12.5000%
Term: 360 months

Period	Pmt Amt	Interest Pd	Pd/Princ	Balance
1	\$1,654.25	\$1,614.58	\$39.67	\$154,960.33
2	\$1,654.25	\$1,614.17	\$40.08	\$154,920.25
3	\$1,654.25	\$1,613.75	\$40.50	\$154,879.76
4	\$1,654.25	\$1,613.33	\$40.92	\$154,838.84
5	\$1,654.25	\$1,612.90	\$41.34	\$154,797.49
6	\$1,654.25	\$1,612.47	\$41.76	\$154,755.72

In the first example (above left), a clear, concise spreadsheet report presents a personalized message at the top and elaborates with numbers below. The second example (top right) uses less text and too many enhancements, which give the report a frivolous look and make it difficult to understand. The absence of formatting in the third example makes it, quite simply, an undifferentiated sea of confusion.

limit most documents to two typefaces.

Use different type sizes and enhancements to set off titles, headings, and subheadings. But don't go overboard: Too many enhancements make a report illegible. Use bold, italic, and underlining only for titles and headers; sans serif fonts such as Helvetica or Swiss make numbers easier to read.

A good photocopier can extend your printer's capability. For example, if your report format is landscape and your printer has the fonts you need only in portrait mode, specify smaller type in portrait mode, and use the copier to reorient the page and enlarge it.

► Consistency Is Critical

If you design multipage reports, you'll want elements to be consistent from page to page. The reader's eye should focus on the message, not the design.

Many spreadsheets provide a style option to maintain a coherent look. You

define a style using fonts, type size, enhancements, colors, and borders; you can apply it to given cells or globally.

It's easy to set up a style. In *Excel 3.0*, select a cell formatted to your liking, then click on *Format*, click on *Style*, and type a name for the style. To apply the style, select the cells you want to format, then click on the arrow next to the current style in the tool bar.

In *1-2-3 2.3*, you can format by selecting any of the WYSIWYG format commands. Then select *:Named-style Define* and specify one of eight styles provided. Select the formatted cell, and give the style a name and description. To apply the style, select *:Named-style*, choose the number from 1 to 8 that represents the style you defined, then select the cells you want to format.

Quattro Pro's styles don't apply across worksheets, but you can "define" up to eight fonts for the same worksheet. Select */Style Font Edit-fonts*, then choose any of eight predefined fonts to

edit. Menus guide you through the definition of typeface, size, color and attributes. To use a defined font in a cell or range, select */Style Font*, choose the font number, and select the cells to format.

When printing a multipage report, you'll want your output to be consistent, too. Selected row and column titles should automatically appear on each page. In *Excel 3.0*, simply select your header row or column, then click on *Options*, and select *Set print titles*. In *Quattro Pro*, use */Print Headings*; in *1-2-3*, select */Print Printer Options Borders*, and choose columns or rows.

Creating an attractive spreadsheet report involves some trial and error. Since you usually can't see an entire page at once, use the page preview to save trips to the printer. By using these rules, you'll create a well-designed report with maximum impact. ●

John Walkenbach is a contributing editor for PC World.

Words Into Print



Word Processing

Tips for getting the most out of your word processor

This month: Address letters quickly with your word processor's boilerplate text features, and import data base files of addresses into Word and WordPerfect.

George Campbell

If you're typing addresses from your Rolodex into letters or other documents, you're wasting the power of your word processor. Instead, why not simply insert addresses electronically? Using any word processor's boilerplate text feature, you can create a list of frequently used addresses for instant insertion.

Using Word Glossaries

In all versions of *Word* prior to version 5.5, you can use the glossary to insert an address automatically. After entering an address and salutation, highlight the text. Press <Esc>c, type any abbreviation to stand for the address, and press <Enter>. To make the shortcut permanent, save the glossary by pressing

<Esc>igs<Enter>.

In *Word 5.5*, follow the same steps but press <Alt>-E0, type the abbreviation, then press <Alt>-D to store it.

Now you can insert the address at the cursor position in any document. Just type the abbreviation and press <F3>, or press <Esc>i<F1> and choose from a list of abbreviations. In *Word 5.5*, press <Alt>-E0 to pick from a list.

WordPerfect 5.x Block Saves

WordPerfect doesn't offer glossary files, but it's easy to create address files, then merge them into your documents.

Type an address and salutation, move the cursor to the beginning of the first line, press <Alt>-<F4>, and mark the block. Press <F10> to save the address, and type a name for it.

Insert an address block in a letter by positioning the cursor, pressing <Shift>-<F10>, typing the block's name, and pressing <Enter>. If you have forgotten the name, press <F5><Enter>, choose the file, then press r.

Automating Long Address Lists

If you work with many addresses, you'll have a hard time remembering all those

WORDPERFECT SHORTCUT

Importing Addresses from Data Base Files

If you have addresses stored in a data base, your *WordPerfect* address list is halfway completed. All you have to do is convert and format the text.

Start by exporting your data in comma-delimited or mail-merge format from within your data base. You'll get an ASCII text file, with records surrounded by quotation marks and separated by commas. Export just the fields you'll use in the address blocks, in the order you'll use them.

To bring the file into *WordPerfect*, press <Ctrl>-<F5>tr, type the path and file name for the exported data, then press <Enter>. Save the file under a new name in case you make an error.

To format the address list, you need to add codes to the

imported data base file. To format the file while it's still loaded, do the following keystrokes, step by step:

1. <Alt>-<F2>n<Alt>-<F2>,<Alt>-<F2><Home><Home><Cursor Up>
2. <Alt>-<F2>n<Enter><Alt>-<F2><Enter><Enter><Alt>-<F2><Home><Home><Cursor Up>
3. <Alt>-<F2>n<Alt>-<F2><Enter><Alt>-<F2><Home><Home><Cursor Up>
4. <Alt>-<F2>n<Alt>-<F2><Alt>-<F2><Home><Home><Cursor Up>
5. To save the new file, press <F10><Enter>y.

If your original data base used separate fields for first and last names, or for cities, states, or ZIP codes, you'll have to do a little editing to finish the job.

abbreviations. Fortunately, you can use your word processor's document-switching and split-screen features to make address selection easier.

Start by creating your address list. Type the addresses in a blank document just as they will appear in your letters, separating each address with a blank line. Then follow these steps:

1. Split the screen or switch documents.
2. Load your address list in the second document.
3. In the address list screen, search for a name or other text.
4. Mark the address as a block.
5. Switch back to your letter document and paste the block in at the cursor position.

Word 4.0/5.0 List Tools

Here's how the process works in *Word*:

Open a blank screen (for the letter), then follow these steps:

1. To split the screen, press **<Esc>wsh12<Tab>y<Enter>**.
2. To load the list, press **<Esc>tl**, type the list's file name, then press **<Enter>**.
3. Press **<Esc>s** to open the search function, enter a name or other informa-



By taking advantage of WordPerfect's split-screen function, you can copy an address from an address file and paste it into your working document.

tion you want to find, and press **<Enter>**. *Word* will locate the address.

5. Select the address text. (If you used **<Shift>-<Enter>** within the address, you can press **<F10>** to select the entire address.)

6. Press **<Delete><Insert><F1><Insert>** to paste in the block.

WordPerfect Address Lists

Users of *WordPerfect 5.0* or later versions can follow a similar approach:

1. To split the screen, press **<Ctrl>-<F3>w12<Enter>**.
2. Press **<Enter><Shift>-<F3>** to switch back to the document window.
3. To load the address list, press **<Shift>-<F10>** and type the list's file name.
4. To search for an address, press **<Home><Home><Cursor Up><F2>**, type the search text, and then press **<F2>** again. If you need to continue the search, press **<F2>** twice to repeat the process.

5. Move the cursor to the beginning of the address, press **<Alt>-<F4>**, then highlight the block with the cursor keys.

6. To copy the block to the letter, press **<Ctrl>-<F4>bc<Shift>-<F3><Enter>**.

With other word processors, you can follow similar steps, substituting the appropriate keystrokes for your program. In *Word* and *WordPerfect*, you can also record macros to further automate the job. ●

George Campbell is a contributing editor for PC World.

WORD SHORTCUT

Importing a Data Base File to Word

If you have a data base file containing addresses, you can turn it into a *Word* address list. Start by exporting the comma-delimited data base file as an ASCII file. (If your data base has more than 500 records, you'll have to break it into smaller chunks.) Then load the exported file into a blank *Word 4.0* or *5.0* screen. Save the file under a new name.

To convert the file for use as a *Word* address list, complete with

proper formatting, press the following keys:

1. **<Esc>r<Tab><Enter><Esc>ts**
2. **<Esc>rp<Tab>pp<Enter><Esc>ts**
3. **<Esc>r<Tab>n<Enter><Esc>ts**
4. **<Esc>r<Tab><Delete><Enter><Esc>ts**

You'll have to do some editing if names, cities, states, or ZIP codes are broken into separate fields in the original data base.

Spreadsheets (A..Z)

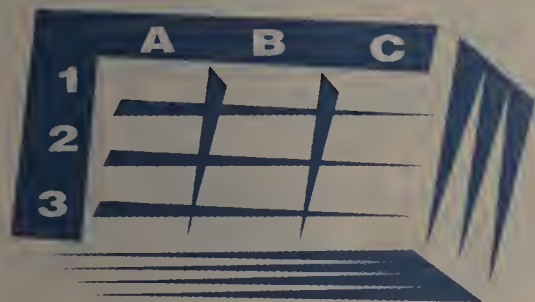

Spreadsheets

Practical tips for building better worksheets

This month: What if...?

Richard Scoville

Survival in business hinges on making smart financial decisions; your spreadsheet program can improve on your intuition by letting you explore options before taking the plunge. This column introduces sensitivity analysis in 1-2-3 release 2.2—a general what-if method for evaluating cost benefits of various scenarios based on one input variable. Our example is purchasing a cellular phone service, but you can apply the same steps to adopting a pricing policy, for example, by projecting profits or to selecting optimum investment plans by projecting returns.

In our scenario, we assume you've already chosen the model of cellular phone you're going to buy. Even more important is which billing plan to select. Most plans charge a base amount each month, which covers a specified amount of airtime. Once you've used up that time, you pay by the minute. You anticipate using the phone for about 75 min-

utes per month; the salesperson suggests the Value plan. It sounds reasonable, but you'd like to know how the bill would look if you used the phone more or less than you've projected.

The worksheet in **FIGURE 1** shows a prototypical approach. It consists of a data entry area containing pricing criteria for each plan based on the single input variable of 75 minutes' monthly usage, a table (generated with the Data Table command) to compare charges for different usage levels, and a graph to provide clear comparisons.

To build the model, begin with a blank worksheet and use the following steps to keep all the numbers consistent: Select */Worksheet Global Format*, and press **<Enter>**. Enter the labels and numbers in A1..F8, and the label in A10. To highlight the data entry cells, move

to cell B3 and select */Range Unprotect*, and press **<Enter>**. Repeat the procedure on the range B6..F8.

Now compute the monthly charges. Move to B10 and then enter the formula `@IF(B3<B7,B6,(B3-B7)*B8+B6)`. In English, this rather tricky formula means that if the number of minutes used ($B3$) is less than the number of free minutes per month ($B7$), then display just the base fee ($B6$); otherwise, calculate the number of minutes used in excess of the free minutes ($B3-B7$), multiply it by the per-minute price ($B8$), and add that figure to the base fee ($B6$). The dollar signs denote absolute cell addresses to ensure that when you copy the formula, all the copies refer to cell B3 instead of the equivalent in other columns. After entering the formula in B3, select */Copy*, press **<Enter>**, move to

Two Ways to Count the Costs

FIGURE 1: One worksheet can show you your least expensive phone rental options in two ways: in a data table, with figures for a range of minutes of usage, and in a graph.

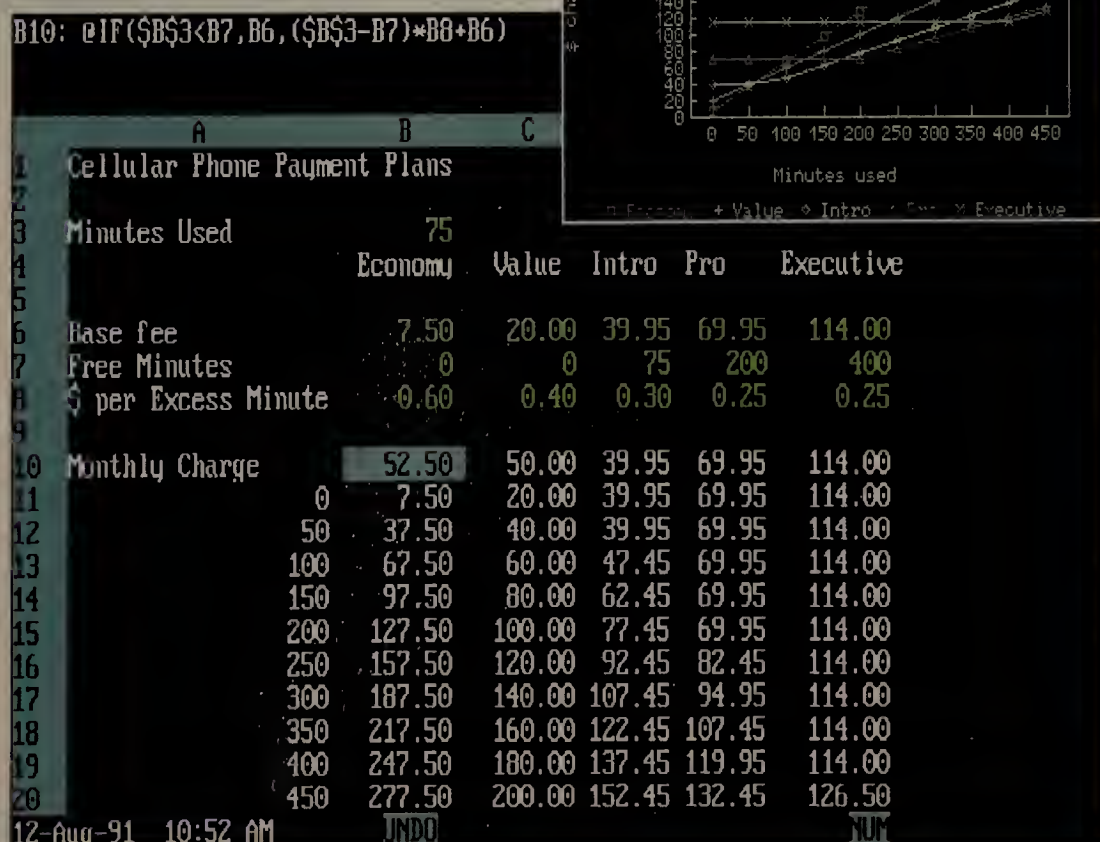

C10, press <Period>, use the cursor keys to highlight the range C10..F10, and press <Enter> again.

By plugging various values into B3, you can compare the cost of the plans for a given amount of airtime; the next step is to build a table to lay out the plan costs for an array of minutes. Start by building the list of minutes: Move to cell A11, select /Data Fill, press <Period>, use the cursor keys to highlight the range A11..A20, and press <Enter>; enter 0 for the Start value, 50 for the Step value, and 450 for the Stop value. Next, the table of charges: Put the cell pointer on A10 and select /Data Table 1, press <Period>, highlight the range A10..F20, and press <Enter>. Then, enter B3 for the input cell.

The table gives you an idea of how costs vary under each plan. To make things clearer, turn the table into a line graph. Put the cell pointer on A11 and (in 1-2-3 release 2.2 or 3.x) select /Graph Group. Press <Period>, use the cursor keys to highlight the range A11..F20, and press <Enter>. Select Columnwise, and the graph ranges are set to display the plan costs. To set up a graph legend, select Options Legend Range, move to cell B4, press <Period>, highlight the range B4..F4, and press <Enter>. Select Color to display your graph in color. Choose Titles to label the *x*-axis Minutes used and the *y*-axis \$ charged. Select Quit to return to the Graph menu, then View to see the data.

Now you've got the big picture. The Economy plan is cheapest when airtime is less than about 50 minutes per month. If airtime is between 50 and about 180 minutes, you'll want the Introduction plan; between 180 and about 375, the Professional plan; above 375, the Executive. For your projected use of 75 minutes, the choice is clear: the Introduction plan. It's interesting that there's always a plan less pricey than the one they recommend. ☺

Richard Scoville and Ralph Soucie are contributing editors for PC World.

SPREADSHEET TOOLBOX

Allowing for Uncertainty in What-If Analysis

If you've ever drafted a budget and suspected you were just guessing at the numbers, you'll appreciate *Delta Manager 1.11*'s frank approach to uncertainty. Instead of the single value a 1-2-3 sensitivity analysis can handle, this add-in lets you enter a range of values. For example, if you think sales will be \$80,000 plus or minus \$10,000, you enter 70000<x<10000. *Delta Manager* assumes your data is based on a normal distribution and takes your high and low values to be the standard error. From then on, all your calculations reflect the appropriate range of uncertainty, which you can adjust to a 68, 95, or 99.7 percent confidence interval. So you might find

out, based on your input uncertainty, that profits will likely range from \$5000 to \$8000 but could go as high as \$12,000 or as low as \$1000!

Like all statistical procedures, *Delta Manager*'s can mislead naive souls who violate its underlying assumptions—for instance, that the input variables for which you've estimated uncertainty are statistically independent. But *Delta Manager* beats guessing, and it can give you a real sense of the range of results you can expect.

Delta Manager \$99.95; PC Publishing, 1033 Massachusetts Ave., Cambridge, MA 02138, 617/661-8050, 617/661-7811 (fax)
Reader service no. 601

EXCEL SHORTCUT

One-Step Graph Title Updates

Ralph Soucie

If you update a worksheet and chart each month—for a sales summary, for example—you can change both titles at once by linking the title cells. To illustrate the technique, open a worksheet and enter a title in cell A1. Enter some sample numbers and select the range containing them, then choose *File New* and select *Chart*.

When the chart file opens, select *Chart Attach Text* and choose the *Chart Title* option.

Type an equal sign, =, then change to the worksheet window and point to cell A1. The cell address appears in the formula bar. Press <Enter>; the text entry in the worksheet appears as the title of the chart. Any changes to the contents of cell A1 will be reflected automatically in the chart title. You can link other chart text objects (such as axis labels and unattached text) to worksheet cells in a similar manner.

Data Basics



Data Management

Tips and techniques for managing your data

This month: The dating game

Steve Cummings

When is as important a business question as *what* or *how much*, and learning your data manager's date-related capabilities can help you find the answer. Whether you want a tally of all your receipts from last October, a list of employees hired after August 1, 1990, a warning to pop up two weeks before a deadline, or the average price you paid for pencils during the past 30 days, you can make good use of some simple functions that identify and manipulate date information.

Let's start with a simple example: suppose you keep a to-do list similar to the one I described in the June column, where every task has a date field called *Deadline*. Think of how convenient it would be (albeit depressing) to quickly pull up your most pressing chores—those due today or (even worse) yesterday. Thanks to your program's *current date* function, you can easily do just that.

No Date Like the Present

Every data manager can read the current date from your PC's system clock. In *dBASE* and its derivatives (like *Alpha Four*, *FoxPro*, and *Clipper*) the function for doing this is called `DATE()`, and you would use it in a command like `LIST FOR Deadline <= DATE()`. In the friendlier *dBASE IV* environment, when you create or modify a query, you would type `<=DATE()` in the box below the *Deadline* heading, then press `<F2>` to get the results. Outside the *dBASE* world, the function has other names: In *Paradox*, it's called `TODAY()`; in *Q&A*, `@DATE`. *R:base* doesn't have a function for this job, but its predefined variable `#DATE` can be used similarly.

Whatever they call their functions, all data management programs let you calculate dates in the same way: When you add or subtract numbers, you add or subtract days. If your *Deadline* field contains the date 08/20/91, the formula `Deadline - 7` produces the date 08/13/91. And to tell your customers their bills are past due after 30 days, your invoice could include the text **Your bill is delinquent after**, followed by a calculated field that adds 30 to the current date; in *Paradox*, you'd use `TODAY() + 30`.

Weeks, Months, and Years

Want to look at the orders you received in a given calendar year? Most data managers have a function that extracts

dBASE SHORTCUT

A Functional, Formatted Date

Lincoln Spector

Ask *dBASE III* or *IV* or any of their clones what the contents of a date field are, and the answer you'll get back will be something like '08/05/91'; fine for your own information, but not for a report. A combination of date and string functions, however, can make the dates in your reports look just the way you want.

For instance, to print a date like 'Monday, August 5, 1991', you would use the statement `CDOW(date field) + ', ' + CMONTH(date field) + ' ' + LTRIM(STR(DAY(date field))) + ', ' + LTRIM(STR(YEAR(date field)))` in a calculated field in your report.

That looks horribly complicated until you know how it

works. `CDOW()` reads a date and writes the day of the week; `CMONTH()` does the same with the month. To get the day's number in a format you can mix with text, use `LTRIM(STR(DAY(date field)))`. The `DAY()` function reads a date and writes the day of the month as a number, 5 in our example. The `STR()` function reads a number and writes a 10-digit text string, so the 5 becomes ' 5'. `LTRIM()` removes the extra blanks, returning the text string '5'. `LTRIM(STR(YEAR(date field)))` does the same job for the year.

The full statement may be large, but it gives you a nice-looking date.

The Three Most Important Companies Big and Small Price, Quality



PC Brand 386SX Application Station

- 16MHz 80386SX CPU operating at Zero Wait States
- 512K RAM (expandable to 8MB)
- 40MB Hard Drive
- 12" Mono Graphics Monitor
- Mono Graphics Card

\$1,067

Add \$160 For SX/20MHz
Lease For \$41/Month

PC Brand 386/25 VGA Windows Workstation

- 25MHz 80386DX CPU operating at Zero Wait States
- 2MB RAM (expandable to 16MB)
- 40MB Hard Drive
- 14" VGA Color Monitor (640x480 res.)
- 16 Bit Super VGA Card
- DOS 4.01/ Windows 3.0/ Mouse

\$1,998

Lease For \$77/Month

PC Brand 386/25 Cache VGA Windows Workstation

- 25MHz 80386DX CPU operating at Zero Wait States
- Cache Processor w/32K Static RAM
- 2MB RAM (expandable to 16MB)
- 80MB Hard Drive
- 14" VGA Color Monitor (640x480 Res.)
- 16 Bit Super VGA Card
- DOS 4.01/ Windows 3.0/ Mouse

\$2,338

Add \$100 For 386/33MHz
Lease For \$90/Month

We Will Customize

Any system to your exact specifications, with name brand Hardware and Software products from vendors like Novell, NEC, Paradise, ATI and many others, at outstanding prices. Call for quotation.

Ask About Our Optional Service Plus Program

- Guaranteed Trade-In on your existing PC Brand Computer when you Upgrade to one of our more Powerful models.
- On-Site Service up to 5-Years

All Systems Include:

- 1.2 MB or 1.44MB Floppy Drive
- 1 Parallel and 2 Serial Ports
- 101 Key Click/Tactile Keyboard
- 200 Watt Power Supply
- Real Time Clock/Calendar with 5-Year Battery
- Desk-Top or Slim-Line Case

Video Options

- Mono Graphics
- VGA Mono
- VGA Color (640 x 480)
- Super VGA Color (1024x768)

Case Options

- Slim Line
- Mini Tower
- Server Tower
- Desk Top

Hard Drive Options

- 40MB
- 80MB
- 100MB
- 200MB
- 320MB
- 640MB

286 Systems also available.
Call for Pricing.

Prices & specifications subject to change. TRW National Computer Maintenance Services-Free 90 Day on site service for 386/SX, 386/DX, and 486's for customers located within a 100 mile radius of any of over 200TRW service centers. On site service for 286's available at extra cost. Call for details.*Monthly payments based on 36 month Lease

Important Reasons Why are turning to PC Brand... and Support.

PC Brand 386/33 Cache Super Windows Workstation

- 33MHz 80386DX CPU operating at Zero Wait States
- Cache Processor w/64K Static RAM
- 4MB RAM (expandable to 16MB)
- 100MB Hard Drive
- 14" Super VGA Color Monitor (1024x768 Res.)
- 16 Bit High Performance Super VGA Card with 1MB Video RAM
- DOS 4.01/ Windows 3.0/ Mouse

\$2,780
Lease For \$107/Month

PC Brand 486/25 ISA Application Workstation

- 25MHz 80486DX CPU operating at Zero Wait States
- Built-In 8K 4-Way Set Associative Cache
- Optional 128K Secondary Cache (Standard with 486/33)
- 1MB RAM (expandable to 16MB)
- 80MB Hard Drive
- 14" Monochrome Grey Scale Monitor
- 16 Bit Super VGA Card

\$2,813
Add \$200 For 486/33MHz ISA
Lease For \$108/Month

PC Brand 486/33 ISA Super Windows Workstation

- 33MHz 80486DX CPU operating at Zero Wait States
- Built-In 8K 4-Way Set Associative Cache
- 128K Secondary Cache
- 4MB RAM (expandable to 16MB)
- 100MB Hard Drive
- 14" Super VGA Color Monitor (1024x768 Res.)
- 16 Bit High Performance Super VGA Card with 1MB Video RAM
- DOS 4.01/ Windows 3.0/ Mouse

\$3,780
Lease For \$145/Month

PC Brand 486/33 EISA Network Tower Server

- 33MHz 80486DX CPU operating at Zero Wait States
- Built-In 8K 4-Way Set Associative Cache
- 128K Secondary Cache
- 4MB RAM (expandable to 32MB)
- High Performance EISA Ethernet Card
- 200MB Hard Drive
- 12" Mono Graphics Monitor
- Mono Graphics Card
- Server Tower Case

\$5,636
Lease For \$216/Month

NEW!

- On-Site Service by TRW†
- 5-Year Prorated Warranty
- Volume Purchase Discounts
- 30-Day Money Back Guarantee
- Unlimited Toll-Free Tech Support
- Tech Support Bulletin Board

PC BRAND™

Tel: 1-800-722-7263 Fax: 1-800-722-7392

Call 1-800-PC Brand Today

PC Brand, Inc. 877 Supreme Drive, Bensenville, IL 60106 • International Fax #708-616-2888 International Voice #708-860-2300 We are open Mon. thru Fri.: 7am to 7pm; Saturday 8am to 4pm Central Time. MasterCard, VISA, Discover, PC Brand Direct Advantage MasterCard, Checks & Approved P.O.s Accepted

WOR891

Circle 198 on reader service card

the year from the full date, ignoring the month and day. *dBASE* calls this function YEAR(); typing YEAR(ORDERDATE) = 1990 in the *dBASE IV* Query Design screen's condition box (brought up with the *Condition Add condition box* option) finds all the orders placed in 1990. *Paradox* calls this function YEAR() too, while in *R:base* it's IYR() and in *Q&A* @YEAR(). Similar functions typically extract the month as a number from 1 to 12, the month as a text string ("August"), the day of the month (in numbers), and the day of the week (as a number or name).

To handle these calculations, your data manager stores dates in a format all its own. If you want to mix a date with standard text—say, to index on Name and Purchase Date together, or to include a date in a sentence—you'll need to convert the date to a text string first. Most data managers have a function for this. In *dBASE* the function is called DTOC(), for Date To Character;



When you define a data base in Q&A, you can pick one of 20 date formats. In reports, you can modify the look further using functions in a calculated field.

if you've stored dates in a field called Sale-Date, the command ? "This item was sold to you on " + DTOC(Sale-Date) displays a

statement like 'This item was sold to you on 08/05/91.'

But that's not the nicest way to display a date. What if you prefer to say 'This item was sold on Monday, August 5, 1991'? Printing a proper-looking date in *dBASE* involves a complicated statement with functions inside of functions (see the sidebar "dBASE Shortcut"). Luckily, other programs offer simpler ways to do this; *Q&A*, for instance, lets you select from a wide range of data formats—from 8/5/91 to 5.08.1991 to August 5, 1991—when you define your data base. However, you'll still need to use a few functions to get Monday, August 5, 1991.

Date functions are useful tools for focusing on the information you really want in your data base. Don't overlook their power. ☺

Steve Cummings is the author of Understanding Quicken (Sybex, Alameda, California, 1990) and a PC World contributing editor. Celeste Robinson is the author of The Best Book of Paradox (Howard W. Sams and Co., Carmel, Indiana, 1990). Lincoln Spector is a PC World assistant editor.

PARADOX SHORTCUT

Monthly Summaries

Celeste Robinson

Reports, particularly annual ones, are often divided by month. A report of last year's sales, for instance, might contain a subtotal for each month. Luckily, the *Paradox* report generator makes displaying a monthly subtotal easy.

Enter the report generator, and arrange your fields in a Form or Table band as you would for any other report. To create another band for the subtotals, press <F10> and select *Group Insert Range*. A menu bar will display the fields in your table; select the date field. You'll next be prompted to group by

Day, Week, Month, or Year; select *Month*.

Next, you must place the new band. Move the cursor into the Page band above or below the form band and press <Enter>. You now have a new band that prints whenever the month in your date field changes. To place monthly sales subtotals in this band, move the cursor into the band, press <F10>, and select *Field Place Summary Regular*. Select your Sales Amount field, then *Sum PerGroup*. When you print your report, your sales will be grouped, and totaled, by month.

The Art of Persuasion



Publishing & Graphics

Expert advice for creating high-impact documents and presentations

This month: creating color presentations, and speeding chart redraws in Freelance

Richard Jantz

Unless you're Woody Allen, putting out your message in black-and-white puts you at a disadvantage. Color helps get your point across more quickly and effectively—a color pie chart is far easier to grasp than one using gray shades or cross-hatching. But choosing the right colors for your overheads or 35mm slides is a lot trickier than flipping open a box of Crayolas.

It's no secret that different colors produce different moods and effects, and that some color combinations look better than others. Top presentation programs like Software Publishing's *Harvard Graphics* and Microsoft's *PowerPoint* provide predesigned *color schemes*—sets of coordinated hues for backgrounds, text, borders, and such elements as the bars in a bar chart. But

they don't tell you which scheme is appropriate for a particular type of presentation or help you create attractive custom color schemes to make your message stand apart from the crowd.

This month we discuss the art of mixing and matching colors to produce effective presentations. For a handy visual guide to colors that work well together, take a peek at the *color wheel* shown in **FIGURE 1**. Then follow these simple guidelines to choose the right colors for your slides, overheads, and on-screen presentations.

- Choose colors that play a meaningful part in your message, such as those used in your company's logo or product packaging. On the other hand,

if you're presenting a bid to, say, Kodak, you may want a color scheme that goes well with that company's yellow-and-red logo.

- Choose colors that reflect the emotional mood of your presentation. For a serious business discussion, use *cool* colors—shades of green, blue, or violet—to evoke a sense of trust. If you're launching a new product line, *warm* colors like red, orange, and yellow help generate excitement.

- Use a consistent color scheme throughout your presentation. If you incorporate existing slides in your presentation, make sure the color schemes match.

- Adjust the color scheme to match

Wheel of Color



FIGURE 1: Color wheels like this have been around for centuries, and they're still useful for choosing colors that don't clash. Colors that are adjacent or opposite provide harmonious color combinations. By changing the lightness and intensity of the colors shown, you can produce millions of additional hues.

your output medium. For example, dark backgrounds and light text work great for color slides and screen shows, but you'll want light backgrounds and dark text for overheads.

- Avoid using too many colors or color contrasts in a chart. Although some programs offer as many as 16 hues per color scheme, the most effective charts use only 4 or 5. If you must add more—say, to represent a dozen bars in a bar chart—use light, medium, and dark versions of a small set of hues.

- Use the color wheel to select harmonious color combinations. To create subtle contrasts (for example, between the shaded areas of a 3-D chart), pick colors that are adjacent on the color wheel. For striking contrasts—to set off the most important part of a chart—choose colors from opposite sides of the wheel.

- If you add color clip art (such as a logo) or scanned images to a slide, make sure the image's colors don't clash with or blend into the other colors in your chart. A picture of the United States flag may add a patriotic touch to a chart, but it won't show up well against a dark blue or red background.

- Avoid using red and green shades to display chart data such as the different sections in an area chart. If members of your audience are color-blind—as are from 6 to 10 percent of the male population—they'll have trouble distinguishing between the red and green sections.

Finally, if color presentations play a starring role in your job, consider adding a color reference book to your library. Two good resources are *The Power of Color in Design for Desktop Publishing* (MIS Press, Portland, Oregon, 1990) and *Color Harmony: A Guide to Creative Color Combinations* (Rockport Publishers, Rockport, Massachusetts, 1987). ●

PC World contributing editor Richard Jantz is the author of *Ventura for Windows 3.0* (John Wiley & Sons, New York, 1991).

DESKTOP PRESENTATIONS TOOLBOX

Clear and Easy Color Transparencies

So you want to print your overheads in living color, but your budget is strictly black and white? Leave the color marking pens and color adhesive film in your desk drawer—now there's an easier way to add a splash of color to those lackluster monochrome transparencies.

3M's Laser Printer Film and Avery's ColorFrames add the color to the transparency *before* you print it. Simply place the transparencies in your laser and print as normal. On 3M's color transparencies, your text and data charts show up crisply against a light-blue or light-yellow background, whereas

Avery's clear transparencies surround your charts with bright blue, green, or red borders. These products cost the same per page as regular transparencies and can be found at most office supply stores. Pick either one to add a dash of color to your next presentation.

Avery ColorFrames (50 sheets) \$32; Avery Commercial Products Division, 818 Oak Park Rd., Covina, CA 91724; 800/541-5507

Reader service no. 616

3M Laser Printer Film (50 sheets) \$26; Visual Systems Division, 3M Austin Center, Austin, TX 78769-2963; 800/328-1371

Reader service no. 617

NUTS & BOLTS

Fast Chart Redraws in Freelance

If you use *Freelance Plus's* drawing tools to enhance your presentation charts, you know how annoying it is to wait for the screen to redraw. The screen refreshes every time you use the View command to change page views and whenever you return to the current page after using the Print Preview command.

Fortunately, there are ways to speed things up. First, you don't have to wait for *Freelance* to redraw the screen completely. By pressing <Esc> or the right mouse button, you can stop redrawing the screen whenever

you want. Second, *Freelance* redraws objects faster if you first turn off the highlight indicators (small squares that identify a selected object). Just press <F8> or use the Options Highlight command to conceal the indicators before the screen redraws.

Finally, you can always move part of a complex drawing to *Freelance's* alternate work space ('Page 2 of 2') while editing, and then move it back to the current page when done. It takes less time for the screen to redraw only part of an image.

Windows Workshop



Windows

Practical advice on mastering Windows 3.0

This month: Learn to tune up WIN.INI.

Jesse Berst and Scott Dunn

Model T owners had to be part mechanic to keep their tin lizzies going. It's not that bad for *Windows* users, but knowing what goes on in WIN.INI, a key part of the *Windows* engine, doesn't hurt.

WIN.INI is an initialization file, a sort of combined AUTOEXEC.BAT and CONFIG.SYS that tells *Windows* and its applications at start-up how the environment is configured, where resources like printers are, and more. If you just need basic transportation, you won't have to dig into WIN.INI, since many of its functions can be managed from the *Windows* Control Panel. But if you want to auto-load programs, fine-tune performance, run *Windows* on a network, or otherwise customize the environment, this is where you start (for a guide to WIN.INI functions and settings and how they relate to Control Panel options, see the figure).

Checking Under the Hood

Since WIN.INI is an ASCII file, you can edit it with any text processor. Or if you double-click WIN.INI in *Windows*' File Manager, it will automatically be loaded in the Notepad.

Poke around, and you'll see that WIN.INI is divided into sections, each with a heading in square brackets. Many of these sections correspond to Control Panel icons. Applications like *Excel* also add sections during installation that specify where a program finds its fonts, dictionaries, and so on.

In each section are statements in the format *function=value*. The value (words or numbers) represents the function's setting. For instance, Spooler=yes tells *Windows* to use Print Manager whenever a *Windows* application prints a file.

Let's Do Launch

One simple modification you can make

to streamline operations is having WIN.INI launch one or more programs every time you run *Windows*.

First, make a backup of WIN.INI. Then open WIN.INI, and at the top of the [windows] section, locate the run= and load= statements. To run a program automatically, type in its full path and executable file name after run=. To load one as an icon on the desktop, use the load= line. To start multiple programs, separate the names with either a *single* space or a comma—but not both. The limit per line is 127 characters.

For example, if you wanted WIN.INI to automatically put *PageMaker 4.0*'s icon on the desktop and open *Excel* and *Windows*' Clock utility, you'd set up the file as follows:

```
load=c:\pm4\pm4.exe
run=c:\excel\excel.exe clock.exe
```

This trick also works for a DOS program. Simply type in its path and either its executable file name or the name of

WINDOWS SHORTCUT











Save Those Program Groups!

Setting up *Windows* so that everything—applications, desktop colors, fonts, and so on—is just the way you want it can take some time. Don't let a system crash, or even the installation of a new *Windows* application, destroy your work. Religiously back up all initialization (INI) files, especially WIN.INI and SYSTEM.INI. When fate strikes, you can restore your backup copies to *Windows*' subdirectory and save yourself a lot of trouble.

Don't forget to back up PROGRAM.MAN.INI too. This file stores the configuration of all the program groups you have laboriously crafted. Just remember that it doesn't include the actual group files (with the extension GRP). If a crash destroys any GRP files, restoring PROGRAM.MAN.INI won't help much—you'll still have to re-create each group from scratch. So be doubly safe and back up all the GRP files as well. In the event of a disaster, you'll be prepared.

WIN.INI Starts Windows the Way You Want It

Here's a guide to the major sections of WIN.INI, Windows' customizable start-up file.

Section name	Function	Primary control point	
[windows]	Settings for many customizing features, including automatic program launching; window border width; speed of keyboard, mouse click, and cursor blink; beep options; program extensions; and various network and printer specifications	Various Control Panel functions	    
[desktop]	Settings for wallpaper, desktop pattern, and grid for placing windows and icons	Control Panel, Desktop icon	
[extensions]	List of file name extensions associated with applications	File Manager, Associate command	
[ports]	Settings for communications and printer ports and for printing file to disk	Control Panel, Ports icon	
[fonts]	List of installed FON-format screen fonts	Control Panel, Fonts icon	
[PrinterPorts]	List of active and inactive installed printers, including port assignments and time-out settings	Control Panel, Printers icon	
[devices]	List of available printers, similar to [PrinterPorts] list but without the time-out settings; used only by Windows 2.x applications	Control Panel, Printers icon	
[colors]	List of RGB values that determine the color of various portions of the Windows interface	Control Panel, Color icon	

the program's PIF file. Note: If two or more full-screen DOS applications are listed on the run= line, only the last one will open full screen.

Auto-Opening Data Files

Automatically opening a specific data file into a *Windows* or DOS application is almost as easy to do. The first trick is associating the file's extension with the application; the second trick is listing the data file (*not* the application) after the run= or load= statement.

The easiest way to associate a file's extension is by running the File Manager. If you want to associate a TXT file, for example, open a directory window and select *any* data file with the TXT extension, then open the File menu and pick the *Associate* command. In the dia-

log box, type in the executable file name of the program you want to associate the data file with (such as **C:\WINDOWS\WRITE.EXE**), and press <Enter>.

If you need to associate more than one file extension with a program, you can do it faster by opening WIN.INI and going to the [extensions] section. The statements here follow the format *nnn=program.exe ^.nnn*, where *nnn* is the data file's extension and *program.exe* the name and path of the executable program file.

For example, to associate all TXT files with *Windows Write*, you'd type **txt=c:\windows\write.exe ^.txt** (A side benefit: Once you've associated the TXT extension with *Write*, double-clicking any TXT file in the File Manager will force *Write* to load it.)

When you've made the necessary file associations, you can finish creating an auto-loading file. Go back to the run= or load= line and type in the name of the desired data file. For example, to load TODO.TXT into *Write* automatically when you start *Windows*, type **run=c:\windows\todo.txt** Save WIN.INI, restart *Windows*, and you're in business.

You've learned the basics—stay tuned next month for some advanced WIN.INI tinkering, including automatic font downloading. ☺

Jesse Berst is a contributing editor for PC World. He and Scott Dunn are coauthors of 101 Windows Tips (Peachpit Press, Berkeley, California, 1991).

The Information Edge



Communications

On-line resources for business and professional users

This month: Find out if Dow Jones News/Retrieval is worth the price, and discover another way of legal networking via the Electronic Bar Association Network.

Judy Heim

Dow Jones News/Retrieval (DJN/R) is a comprehensive on-line source of business information, offering up-to-the-minute stock quotes along with access to the full text of 350 business newspapers and magazines. Its only flaw is sky-high pricing. Dow starts at \$7.60 an hour (300 baud at night), but when you add daytime access fees, surcharges for certain services, and a nasty per-character charge, you can end up paying \$171 per hour—plus an \$18 annual service fee. Some surcharges are lower, but most of the useful features hover uncomfortably close to that \$171 price point.

Q. What's available on Dow Jones News/Retrieval?

A. DJN/R consists of four main data bases:

- Business and World Newswires holds the Dow Jones business news wires, plus the *Wall Street Journal*, *Barron's*, and Japan's Kyodo news wire.

- Dow Jones Text Library contains the full text of 350 national and regional business publications.

- Company/Industry Information offers a wide range of data—including earnings forecasts, company reports, and analysts' reports—on all publicly traded companies in the world.

- Quotes, Statistics, and Commentary delivers current and historical stock quotes as well as mutual fund reports.

Best of all, DJN/R is easier to search than a newspaper stock quote listing. You can choose a fast command-line interface or well-designed menus. To search the full text of news wire and publication holdings, simply enter the words you want to search for, and (if you like) a date range. Dow checks its files and returns a list of headlines. Once you select those that interest you, full text scrolls across the screen.

Q. What does DJN/R offer that you can't get anywhere else?

A. It's the only on-line source for the four Business and World Newswires, plus full text of the *Wall Street Journal*, *Barron's*, *Business & Finance Report*, and *American Demographics*. Also exclusive: transcriptions of the TV show *Wall Street Week* and up-to-the-minute reports on SEC filings. But Dow's main draw is its up-to-the-second stock quotes. CompuServe, GENie, and Prodigy also offer stock quotes, and for a lot less, but only with a 15-minute delay.

Q. Can I find any of the nonexclusive information on DJN/R elsewhere for less?

A. Yes, indeed. GENie offers daily and historical stock prices for just \$4.95 a month, if you log on at night.

CompuServe (CIS) offers a variety of useful financial features. For instance, Rategram lets you search for securities and certificates of deposit with the highest return, and several other features make it easy to analyze your investment portfolio. CIS also offers Vestor Buy/

ON-LINE SHORTCUT

Choosing the Fastest Error Correction Protocol

If you're downloading files from CompuServe, always use its proprietary error-checking protocol, CompuServe-B. This protocol is really fast, mainly because of its large block size and because it doesn't pause between blocks for an acknowledgement. On other on-line services,

YMODEM or ZMODEM are your best choices. The former gains speed thanks to the large blocks in which it sends data; the latter sends information in highly efficient data streams instead of blocks (but falls back to block format if it encounters line noise).

Sell Recommendations and Money Magazine's Info Center.

Basic hourly charges on CIS range from \$6 to \$12.80, plus \$2 per month. True, some CIS features have surcharges, but they are generally much lower than you'll find on DJN/R. For example, Money Magazine's Fund-Watch Online actually offers more details than you'll find on DJN/R, and it costs only \$21 to \$27.50 an hour. On DJN/R you pay \$36 to \$171 an hour, plus per-character charges.

Q. Will DJN/R track news on particular companies that interest me?

A. You bet—if you're willing to pay the price. DJN/R's clipping feature, which also costs \$171 an hour (2400 baud during the day), lets you create up to ten folders with five search phrases in each. It culls all appropriate news from the DJN/R news wires; then every time you log on, the scoop is waiting for you. DJN/R's tracking feature lets you keep tabs on stock prices as well as breaking news on 25 companies or industries—and it costs the same \$171 an hour plus an additional \$82 a month. But remember, almost every on-line service, including CompuServe, GEnie, and NewsNet, offers similar capabilities for a whole lot less.

Q. If I decide DJN/R is worthwhile for my business, how can I keep my bills down?

A. Log on after hours. DJN/R's evening rates and surcharges are dramatically lower than its day rates. And invest in a 2400-baud modem (the fastest DJN/R supports), which lowers your bit-per-second cost. That way if you really need up-to-the-second quotes and other exclusive goodies from DJN/R, you'll know you're getting them at the best possible price. ☉

Judy Heim is a contributing editor for PC World. Nick Kees is an intellectual property lawyer in Mil-

THE PROFESSIONAL EDGE

Electronic Bar Offers Lawyers an On-Line Alternative

Nick Kees

If your legal firm is counting pennies, or if you're a law student who can't yet afford to fly first class, check out a new low-cost on-line service for lawyers: the Electronic Bar Association Network.

Like the better-known ABA/net, EBA/net offers on-line conferences, E-mail, legal forms, and access to research data bases. Unfortunately, EBA/net is somewhat underpowered. Its message conferences are sparse, and you can't send E-mail to outside services. Since it has fewer members, opportunities for networking are thin too. And while the price is low, it's not *that* low.

Still, EBA/net is only a few steps behind ABA/Net. Its access to essential data bases like Lexis/Nexis, Dialog, BRS, Vu/Text, and NewsNet is just as strong. And you'll find more than 900 legal forms—including promissory notes, contracts, bankruptcy forms, corporation forms, and litigation-related forms—in the format of every

leading word processor. The forms are available on ABA/net too, but only uncompressed—and costing \$400 per hour at 2400 baud. EBA/net offers compressed ZIP files at no extra cost. And if you're looking for on-line access to the popular *Law MUG Newsletter*, you'll find it here, exclusively.

A subscription to EBA/net is \$10 per month, plus hourly charges that range from \$11 to \$17. ABA/net's hourly charges are about the same—but while there's no monthly charge, you're stuck with a \$30 monthly minimum and hefty surcharges. For very small firms, especially those that don't need to be on line every day, EBA/net's cost savings will be welcome. But most legal outfits will probably be happier with ABA/net with its bigger subscribership and wider choice of forums.

EBA/net Electronic Bar Association Legal Information Network, P.O. Box 11191, Chicago, IL 60611-0191, 312/951-8451

Reader service no. 605

waukeez specializing in software and electronics.

For more information about all services in this article, circle reader service no. 901.

WHERE TO BUY

Dow Jones News/Retrieval
P.O. Box 300
Princeton, NJ 08543
800/522-3567 ext. 2224
Reader service no. 602

General Electric Information Service

401 N. Washington St.
Rockville, MD 20850
800/638-9636, 800/638-8369 modem
(type **hhh**<Enter> when you get the connect string, then type **signup** when you see U#=)
Reader service no. 603

CompuServe Information Service

5000 Arlington Centre Blvd.
P.O. Box 20212
Columbus, OH 43220
800/848-8199
Reader service no. 604

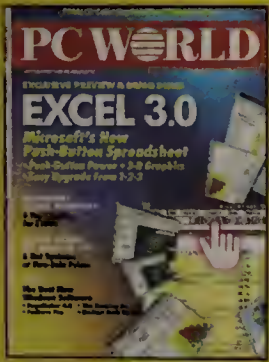

Subscribe to PC WORLD and save 58%. Plus, receive 42 Free Utilities.

You'll receive FREE our PowerBase** Disk complete with 42 Tips and Utilities to use with your software packages. Tips and tricks for:

- WordPerfect ■ Turbo C
- Turbo Pascal ■ Basic
- Paradox ■ Lotus 1-2-3
- WordStar ■ And much more!

Yes, I want to stay ahead of the competition with PC WORLD's product reviews, hot news and How To tips and techniques. I'll pay only \$19.97 for 12 monthly issues-almost 58% off the annual newsstand price-plus I'll receive FREE PC WORLD's PowerBase** Disk.

NAME _____

COMPANY _____

ADDRESS _____

CITY/STATE/ZIP _____

**Mail this card or
Call 800-825-7595**

Basic annual subscription price is \$29.90. Savings based on annual newsstand price of \$47.40. Please allow 6 to 8 weeks for delivery of your first issue. Offer good only in the U.S. PowerBase** diskette is offered solely by PC WORLD Magazine. It should not be confused with "power-base" which is relational database software offered by Compuware Corporation.

PC WORLD

4F284

+
58%
OFF

+





NO POSTAGE
NECESSARY
IF MAILED
IN THE
UNITED STATES

BUSINESS REPLY MAIL
FIRST CLASS PERMIT NO. 1262 BOULDER, CO

POSTAGE WILL BE PAID BY ADDRESSEE

PC WORLD

Subscription Department
P.O. Box 51833
Boulder, Colorado 80321-1833

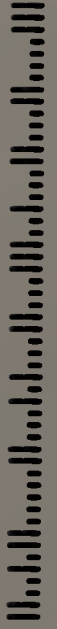

User Group Tips

Helpful hints from members of the nation's user groups

Around the Block Again With WordPerfect

Tired of running around the block in *WordPerfect* every time you need to make more than one change to a section of text? There's an easy way to avoid manual reblocking after boldfacing, underlining, or moving text. Once you have marked the original block and, say, underlined the text, just press **<F12>** or **<Alt>-<F4>**, and then press **<Ctrl>-<Home>** twice. The block will be re-highlighted, and your cursor will snap back to where you began the block.

Thomas M. Taulli

Pasadena IBM Users Group

Mouseless Ami Pro Word Deletes

Windows word processing jocks get so accustomed to using a mouse, they sometimes overlook more efficient keyboard solutions. Sure, it's great to be able to delete large blocks by highlighting with the mouse and pressing **<Delete>**. But when you have to remove a number of single words in one section of a document, this method can actually slow you down. It's often easier to jump the cursor a word at a time with **<Ctrl>-<Cursor Right>** or **<Ctrl>-<Cursor Left>**, a sentence to the right with **<Ctrl>-<Period>**, or a sentence to the left with **<Ctrl>-<Comma>**. Place the cursor on the first character of the word you want deleted, and use **<Ctrl>-<Shift>-<Delete>** to clip the word with any trailing spaces. You'll get the job done quickly while keeping your hands on the keyboard.

Ronald Ogg

Diablo Valley PC Users Group

Copy AUTOEXEC.BAT for Protection

If your system starts misbehaving, check **AUTOEXEC.BAT**—the file in your root directory that initializes your system when you boot up. Software you've recently installed may have changed it. If you're on a LAN, for example, adding a **PATH** command to the end of your **AUTOEXEC.BAT** may wipe out the network drive mapping, preventing you from working with the LAN as you're used to. Other changes can be more subtle; some programs don't even let you know they're making them. If you're like most users and have only a nodding acquaintance with your **AUTOEXEC.BAT**, it can be hard to spot changes.

Right now, while everything is working the way you want, archive a copy of **AUTOEXEC.BAT**. You should have a separate **\DOS** directory for all DOS files on the **C:** drive of your hard disk. Enter **copy c:\autoexec.bat c:\dos**. Then, if you experience problems with your system, enter **comp c:\autoexec.bat c:\dos**. If the two files are different, print them to see what's changed in the new one.

If you can't spot an obvious troublemaker, use an ASCII editor to remove all the new lines except the first. Reboot, and if everything works all right, add another line and boot again. Repeat the process until you have identified the problem instruction. Remove the offending line, and call the software vendor's technical support to help find a work-around that will let you use the program in your environment.

Charles Suitt

North Texas PC Users Group

A Neat Wrap-Up for Long Text Fields in Paradox Reports

If your *Paradox* tables have fields from 80 to 255 characters in length, you can't show their contents in single lines on a

standard screen or in a letter-width report. But you can use **WordWrap** in the *Paradox* report generator to print long fields out on a few neat lines.

Press **rd*** **<Enter>** and select the name of the table. Highlight the number of an unused report, press **<Enter>**, type a description, and press **f** to design a free-form report. You'll see a design screen containing every field in the table in a vertical column. Delete any elements you don't want: Press **fe** and place the cursor on fields you want to erase; you can remove nonhighlighted text elements if you like, with **<Backspace>** and **<Delete>**.

Press **<F10>fp** and select the field type; you'll bring up a list of the fields of that type in the table. Select the field you want to wrap, and cursor to where you want to start. Press **<Enter>**; the cursor will go to the right end of the line. Hold down **<Cursor Left>** to move to where you want the right margin. Press **<Enter><F10>fw**, and press **<Enter>**. Answer the prompt and enter the number of lines sufficient to display the contents of the field. A notice will appear at bottom right letting you know the word wrap value has been recorded. Select any other fields you want to include in the report, and then take a look at the output: Press **<F10>o** and select *Printer, Screen, or File* for your report. You'll get clean, professional results.

Steve Feldman

Twin Cities PC User Group

Are you a user group member with a tip to share? Send it to User Group Tips, PC World, 501 Second St. #600, San Francisco, CA 94107; Compu-Serve 74055,412; MCI Mail PC World Editorial; or 415/442-1891 (fax)—include your phone number. We pay \$50 and throw in a PC World T-shirt for each tip we use—and you get to see your name in PC World. ☺



While others struggle to break into Windows, the #1 Windows database just got better.

If you're moving your database operations to Microsoft® Windows™, you need dependability and experience. You should be looking at Superbase®, the world's best-selling Windows database.

Superbase has all the tools you need to create Windows relational database applications that really work. An intuitive and easy-to-use interface. A superior Form Designer. Powerful procedural and non-procedural tools for application development. Full DDE and DLL support. Network connectivity and WYSIWYG functionality. Even non-programmers can build powerful applications quickly and easily.

And now, Superbase SQL Library lets you connect to multiple SQL databases and servers like Microsoft SQL Server, Gupta's SQL Base®, Oracle® Server and others. Concurrently.

Proven Performance

While other companies scramble to produce their first Windows version, Superbase is celebrating its third year as a Windows database technology. Three years of continual refinement have made the new Version 1.3 the solid, dependable and easy to use product that it is today.

Which is why it is the leading Windows DBMS. Why it is used with confidence by major corporations around the world. Why it was selected by Microsoft and AT&T for some of the largest Defense Department and US Government PC contracts ever awarded. And why hundreds of VARs and systems consultants use it as their database platform of choice for Windows application development.

A Complete System

Superbase is a complete family of products designed to meet a broad range of requirements, from executive use with Superbase 2, to MIS application development

with Superbase 4. Not only are these products fully upward-compatible, but applications designed with Superbase 4 can run with Superbase 2 as well as with royalty-free Runtime Systems. Version 1.3's Network Extensions offer state-of-the-art concurrency control on networks, while Superbase SQL Library ensures easy integration with SQL database servers.

Find out why Superbase is the only Windows database that can meet all

of your Windows database needs.

Visit your dealer today or call us for information and a working model demo disk.

PRICING:

Superbase 2	\$345.00
Superbase 4	\$695.00
Superbase SQL Library	\$495.00
Superbase 4 Developers Edition	\$1295.00
Superbase 4 Developers Upgrade (Runtime)		\$600.00
Superbase Network Extensions	CALL

Superbase is available through all major retail dealers including Egghead Software, Corporate Software, SoftWarehouse and independent dealers and VARs everywhere. All prices are US list.

SUPERBASE®

1-800-562-9909

Precision, Incorporated

8404 Sterling Street • Irving, TX 75063

Tel: (214) 929-4888 • Fax: (214) 929-1655

Superbase is a registered trademark of Precision Software, Ltd. Precision acknowledges all trademarks belonging to their respective companies.



MICROSOFT
WINDOWS
Version 3.0 Compatible Product

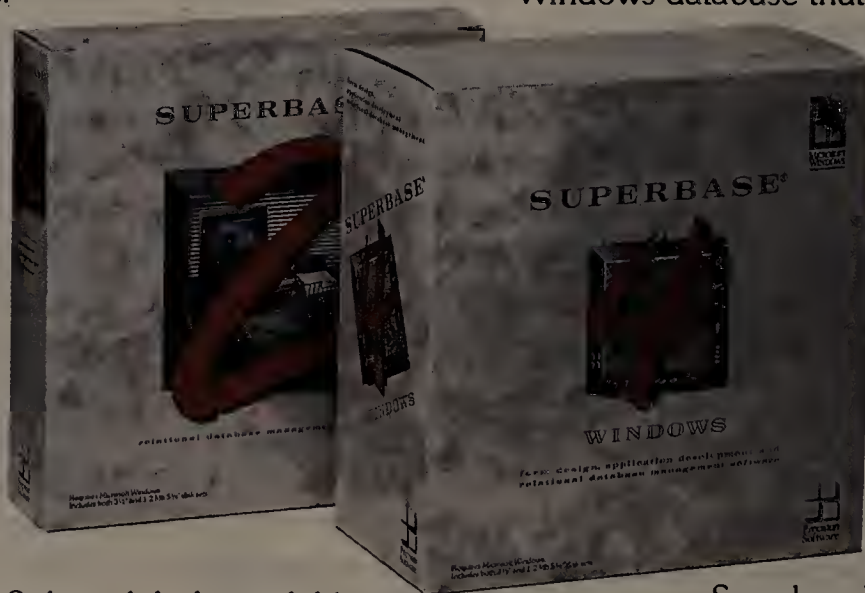

Circle 244 on reader service card

Precision
Software

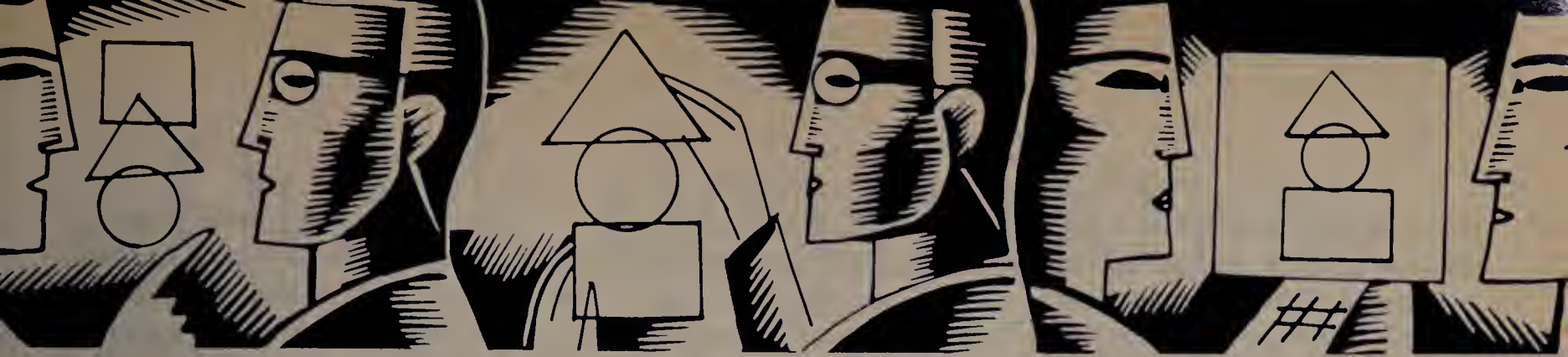

STAR-DOT-STAR *.*

A global exchange of personal computer discoveries

List available memory and disk space fast and in color, shrink your Q&A and ThinkTank data bases, delete multiple files in one swell foop, check your 1-2-3 errors at the door, and read about DOS and assembly.

Edited by Brett Glass

To Boldly Go Where CHKDSK Can't

Every time I use CHKDSK.COM, I want it to tell me just two things: how much space is left on my disk and how much memory is free. On a fast machine this information comes quickly, but on an early PC or one with a slow hard disk, the wait can be intolerable. This problem led me to develop Freespace (FS.COM). It's many times faster than CHKDSK, produces a clearer display (in color on most machines), and needs less than 4K of RAM, as opposed to CHKDSK's 40K.

I've tested Freespace on 8088s,

80286s, and 80386s using DOS 3.0 to 3.3. To use it, type `fs d:` where `d:` is any valid drive. If you type just `fs`, the program uses the default drive.

*Brian Mowers
Southfield, Michigan*

Editor's note: Mr. Mowers doesn't mention one of the best applications for his program: networked drives, where CHKDSK, which needs exclusive access to the physical drive, doesn't work at all. I altered his original code to let the program work on disks larger than 64MB and to fix a few minor bugs.

To create the program, type the seemingly senseless text in LISTING 1 into an ASCII text file called FS.DAT.

Double-check the code for errors. At the DOS prompt, type `debug <fs.dat` to create your FS.COM program file, which you should then move to a directory listed in your PATH command.

If you compare FS.COM's memory estimate to CHKDSK's, you'll see that it's more conservative. The reason: CHKDSK adds back its environment space and FS doesn't. FS's number is probably closer to the actual amount of memory a program will have available when it runs.

Slim Down Your Symantec Data Base Files

Surprise! Your disk is just as crowded (continues)

```
N MF.COM
E 0100 FC 33 D2 BE 80 00 AC 0A C0 74 08 46 AC 24 5F 2C
E 0110 40 8A D0 B4 36 CD 21 3D FF FF 75 09 BA 2E 02 B4
E 0120 09 CD 21 EB 52 BE 23 02 F7 E1 F7 E3 B9 0A 00 D1
E 0130 EA D1 D8 E2 FA BB 10 27 F7 F3 8B F8 8B C2 B9 04
E 0140 00 E8 8A 00 8B C7 B9 03 00 E8 82 00 BE 1B 02 B9
E 0150 08 00 E8 8F 00 BA 0A 02 B4 09 CD 21 B4 03 CD 10
E 0160 BD 1B 02 B8 01 13 BB 4F 00 B9 09 00 B2 11 CD 10
E 0170 BA 25 02 B4 09 CD 21 2E A1 02 00 8C CB 2B C3 B9
E 0180 10 00 F7 E1 BE 02 02 B9 04 00 73 3C BB 10 27 F7
E 0190 F3 8B F8 8B C2 E8 36 00 8B C7 B9 02 00 E8 2E 00
E 01A0 BE FC 01 B9 06 00 E8 3B 00 BA F0 01 B4 09 CD 21
E 01B0 B4 03 CD 10 BD FC 01 B8 01 13 BB 4F 00 B9 07 00
E 01C0 B2 2E CD 10 B4 4C CD 21 41 E8 02 00 EB D2 BB 0A
E 01D0 00 33 D2 F7 F3 80 CA 30 88 14 4E 80 3C 2C 75 01
E 01E0 4E E2 EE C3 80 3C 30 77 06 C6 04 20 46 E2 F5 C3
E 01F0 DE 20 46 72 65 65 20 52 61 6D 3A 20 20 20 20 2C
E 0200 20 20 20 20 62 79 74 65 73 24 46 72 65 65 20 44
E 0210 69 73 68 20 53 70 61 63 65 3A 20 20 2C 20 20 20
E 0220 2C 20 20 20 24 20 4B 20 62 79 74 65 73 24 07 20
E 0230 2A 2A 2A 20 44 72 69 76 65 20 6C 65 74 74 65 72
E 0240 20 69 73 20 69 6E 76 61 6C 69 64 20 2A 2A 2A 20
E 0250 20 24
RCX
0152
W
Q
```

LISTING 1: This file, FS.DAT, contains DEBUG keystrokes to create FS.COM, a speedy utility that displays free disk space and RAM.

after you delete records from a Q&A data base as before. For instance, I had an employee information data base named PERSON with 440 records in it. A directory listing showed a 675K DTF file and a 343K IDX file. After using Q&A's *File Remove* command to remove all but 20 of the entries, as far as DOS was concerned I still had nearly

1MB tied up in those files.

To remedy this problem, copy the contents of your old data files to new ones, then rename the new ones: After deleting a large number of records, select *File Copy Copy design with IA info* from the Q&A main menu, and call your new files something like PERSON2. Next, select *File Copy Copy selected*

forms. Press <F10> twice to copy all the nondeleted records in the data base; the new DTF and IDX files will be considerably smaller. You may now use DOS to delete the original files and rename the new ones.

*Emmett A. Dulaney
Fort Wayne, Indiana*

Editor's note: Q&A isn't the only Symantec product with this problem. No matter how many headlines and documents you delete from a ThinkTank outline file, it stays at the largest size it's ever been. The solution for ThinkTank is similar to the one for Q&A: Write the contents to a file (in ThinkTank's case, a "structured" file), then create a new data base, and read the data back in using the Port Text Receive Wordprocessor command. Other products, such as Borland's Reflex, pack their data bases on command, making these measures unnecessary.

Delete Tall Heaps of Files in a Single Bound

I use UNIX as well as DOS, and I prefer
(continues)

So You're Feeling Squeezed

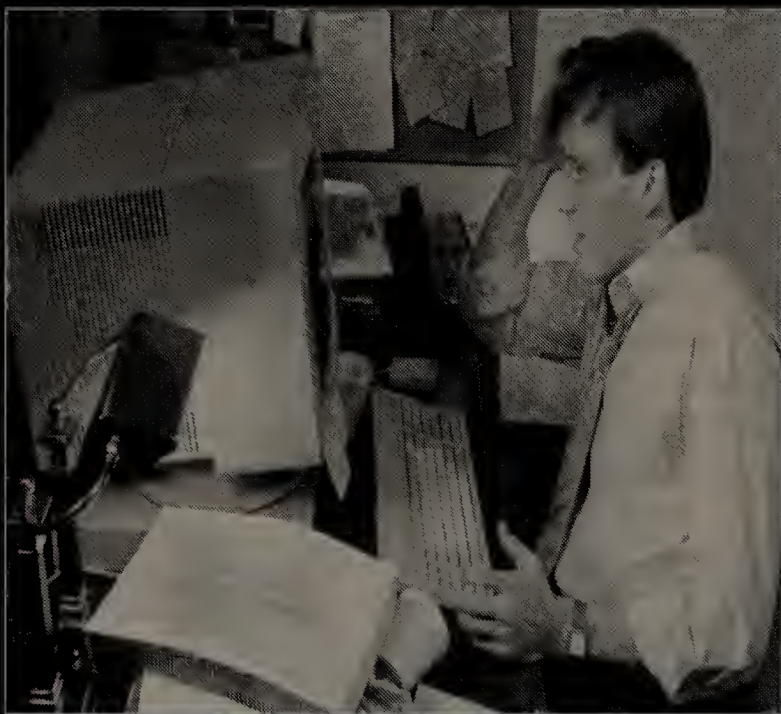

Another typical day at the office — rush projects, training seminars, capital crunches and trade shows — just for starters. No need to panic. *Now there's help.*

Rent a PC or a workstation from Genstar — Apple, IBM, Compaq, Toshiba or Sun Microsystems. Get the equipment overnight and keep it as long as you want. Imagine using state-of-the-art equipment with no obsolescence worries. Plus, you can expense, rather than capitalize, to take the pinch off your balance sheet.

One call and we're on your team. Together, we'll find the best way to take the squeeze off. Call toll free today.

GENSTAR
RENTAL ECONOMICS, INC.

1-800-422-3300 (US)

1-800-387-6646 (Canada)

1-800-361-5447 (PQ and the Maritimes)

POWER TIP NO. 198

Setting Date Formats in Worksheet Headers and Footers

To print the current date in your 1-2-3 or Quattro Pro worksheet, place @ in the header or footer. The format of the printed date is determined by the format you select for the clock display on the status line. You can reset the date's format with /Options!Other!Clock in Quattro Pro or /Worksheet Global Default Other Clock in 1-2-3.

*Robert J. Sandler
New Milford, New Jersey*

Quick, do you know
the first name
in microprocessors?

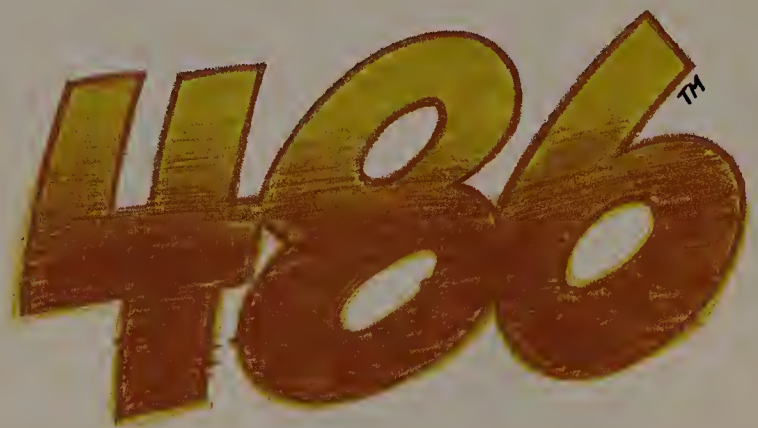
_____  486™

_____  386

_____  386SX™

its RM (remove) command to DOS's DEL and ERASE as a way of deleting files. RM lets you delete many files by specifying them all in one command line, such as `rm fhm.* *.doc *.dat test.drw *.dwg`, something DEL could never dream of. To bring this old UNIX friend into the DOS world, I developed a batch file, RM.BAT [see LISTING 2]. Put this file

in a directory on your path, and you can delete up to nine files or wild-card file groups. Note that if you're using an earlier version of DOS than 3.1, you need to remove the @ sign at the beginning of the 'Echo off' command in this file.

*Faheem Ahmad
Blacksburg, Virginia*

```
@echo off
if "%1"==" " goto MSG
if "%1"==" /?" goto MSG
:START
if "%1"==" " goto END
erase %1
shift
goto START
:MSG
echo Deletes the files listed
echo on the command line.
echo Wildcards are allowed.
echo RM file [file [file...]]
:END
echo on
```

LISTING 2: RM.BAT deletes lists of filespecs (each of which may contain wild cards) in one swell foop.

Editor's note: This batch file is an excellent demonstration of the DOS SHIFT command, which "steps" through a list of batch file arguments so %2 becomes %1 and %3 becomes %2, allowing you to process up to nine parameters in a loop. The OS/2 shell's ERASE and DEL commands already allow multiple file specs, but Microsoft hasn't added them to DOS for fear of creating incompatibilities.

To ERR Is Electronic

In a 1-2-3 worksheet, I have to calculate the difference between two numbers as a percentage of the second one. I used to do this with the formula $(B12-C12)/C12$. But if cell C12 was empty, which it was if I hadn't yet typed a value, the formula produced an ERR value. That didn't suit me; if C12 was blank, I wanted the cell with the formula to be blank as well.

To solve the problem, I replaced the formula with a new one, `@IF(@ISERR((B12-C12)/C12)," ",(B12-C12)/C12)`, which leaves the formula cell blank if C12 is empty. The @ISERR function evaluates the original formula and returns a true value if the result is ERR. @IF puts a blank in the cell if @ISERR is true or does the calculation again if @ISERR is false.

*Robert Siegel
Vienna, Virginia*

(continues)

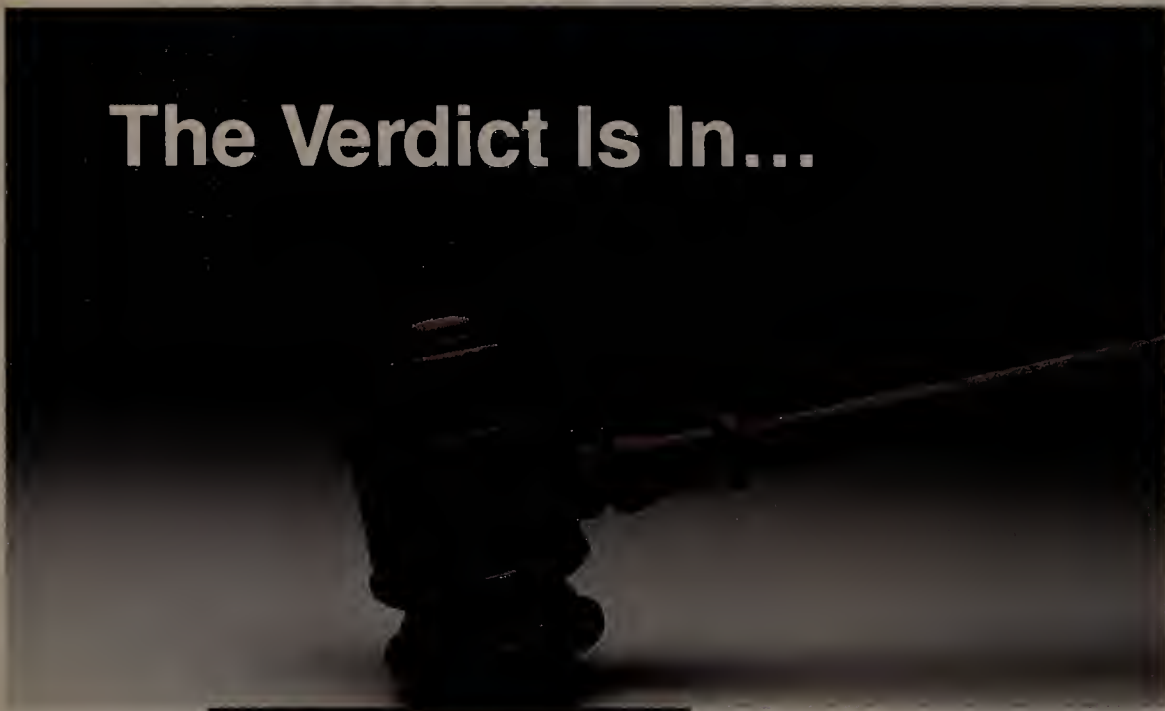

The Verdict Is In...

CLARION
PROFESSIONAL DEVELOPER™

Simply the Best.

"We've always liked Clarion's powerful, straightforward language, which has the readability of COBOL or BASIC and the structural integrity of Pascal. And it's more economical than any of these, getting more done in a line of code than virtually any other language...Clarion Professional Developer 2.1 goes beyond these basic strengths."

PC Magazine — Technical Excellence Awards

"Corporate developers and buyers delivered the highest overall score to Clarion Professional."

PC Week — Winner of Corporate DBMS Satisfaction Poll, 1989/1990

"Clarion is the system of choice for the serious applications programmer." **InfoWorld**

"It is almost easy enough for a novice to use...but programmers will find its editor and full-feature procedural language gives them plenty of room to maneuver."

PC Magazine — Editor's Choice



CLARION SOFTWARE™
150 East Sample Road
Pompano Beach, Florida
(305) 785-4555 • 1-800-354-5444

Circle 36 on reader service card

Time's up.

Intel 486™

Intel 386™

Intel 386SX™

You scored perfectly. Because Intel is the world's leader in microprocessor design and development. It's also the company that introduced the first microprocessor. And when it comes to investing money into the technology, Intel is first again. Giving you the assurance that with an Intel microprocessor inside your computer, you'll have the power and compatibility to take you into the future.

So if you want all that working for you, make sure the 386SX, 386 or 486 computer you choose has the first name in microprocessors inside. Intel.

intel®
The Computer Inside.™

Intel486, Intel386, and Intel386SX are trademarks of the Intel Corporation. ©1991 Intel Corporation. All rights reserved.

Circle 112 on reader service card

YOU WANT MORE INFORMATION BEFORE YOU BUY?

YOU GOT IT!

Turn to the Reader Service Card and product indexes at the back of this issue of *PC World*, circle the number of the product or company you want information about, and send it in.

We'll pay the postage. It's just another way that *PC World* delivers more of the news, reviews, and information you need to make intelligent PC buying decisions.

PC WORLD

**PC WORLD
GIVES YOU A
WINNING HAND!**

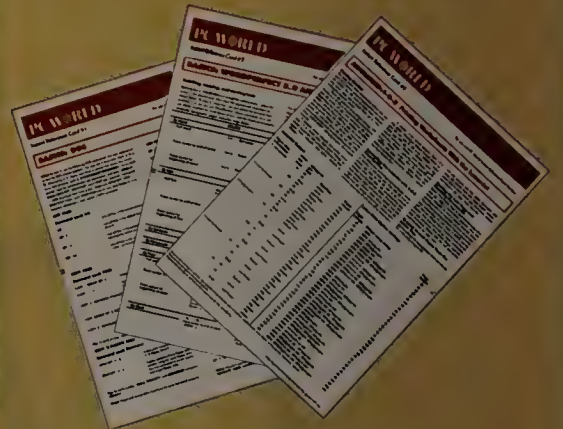

Tired of flipping through user manuals?

Can't *find* the user manual?

Need lightning-quick access to key commands and features?

Need a software reference you can take anywhere?

**PC WORLD'S NEW
INSTANT REFERENCE CARD
IS YOUR BEST BET.**

This monthly pullout card gives you a full house of tips on using essential applications. One side provides basic commands that get you started; side two raises the stakes, with advanced pointers to help experienced users squeeze every bit of productivity out of their software and hardware investment.

**LOOK FOR THESE
INSTANT REFERENCE CARDS:**

WordPerfect
Microsoft Word
Windows 3.0
Procomm Plus
Ventura Publisher
Paradox
Excel
PageMaker
1-2-3
DOS
CompuServe
...and more!

BASICS: DOS 5.0

How it works: When you start your PC, DOS's command processor, COMMAND.COM, starts automatically. This program brings DOS's internal commands into memory ready for you to run by typing their names at the DOS command line or prompt. Commonly used internal commands include CD, COPY, DEL, DIR, MD, and RD. In addition, DOS provides external commands, each with its own executable file, which you should store in a directory named \DOS on your hard disk. These files have EXE or COM extensions, for example, CHKDSK.COM, COMP.COM, and XCOPY.EXE. A BAT, or batch, file is a text file in which you list a sequence of commands, each on its own line. If named AUTOEXEC.BAT and stored in the root directory of the boot drive (A: or C:), it executes automatically whenever you start your PC.

ENTERING DOS COMMANDS

You can run an internal command (and any file with an EXE, COM, or BAT extension) by typing its name (without the extension) and pressing **<Enter>**. You can define some commands more specifically with the use of *switches*—characters or words that follow a command, often separated from it by a forward slash (/). DOS provides the following command line options:

Don't execute the command	<Esc>
Pause a command	<Ctrl>-S or <Pause>
Stop a command	<Ctrl>-C or <Ctrl>-<Break>

DOS also enables you to edit and reuse the last command entered.

Copy one character at a time	<F1> or <Cursor Right>
Copy up to a character	<F2> character
Copy all remaining characters	<F3>
Delete up to a character	<F4> character
Edit a command without executing	<F5>

NAVIGATING YOUR HARD DISK

If an external command is not in the default directory of the default drive, you can either prefix the command with its drive and/or directory path, or change to that directory and then issue the command. An alternative to these methods for commonly used commands is to issue a PATH command that lists their directories.

Give DOS a list of directories to search for commands	PATH=C:\DOS;C:\BATCH;C:\123
Make DOS prompt display the default directory	PROMPT \$P\$G
List a directory's files and subdirectories	DIR C:\DIR1
List them in five columns, one screen at a time	DIR C:\DIR1 /W /P
List files with an EXE extension in the default directory of the default drive	DIR *.EXE

Note: The asterisk, or star (*), represents any number of characters; the question mark (?), only one. You can use definite characters in conjunction with wild cards (e.g., R???.EXE, R*.*). to be more specific.

Change to drive A:	A:
Change the default directory	CD C:\DIR1\DIR2
Create a new directory	MD C:\DIR1\NEWDIRECTORY
Remove a directory	RD C:\DIR1\OLDDIRECTORY

Note: You can't remove a drive's root directory (e.g., A:\), the directory you're in when you issue the RD command, or a directory containing files or subdirectories.

HANDLING FILES

Enable/disable subsequent copy verification

Copy a file from the default directory to a specific directory

Copy a file to the default directory

Copy a file under a different name

Compare a file with its copy

Delete a file

Rename a file without copying it

View the contents of a text file

VERIFY ON/VERIFY OFF

COPY FILENAME.EXT C:\DIR1

COPY C:\DIR1\FILENAME.EXT

COPY C:\DIR1\FILENAME.EXT

C:\DIR2\NEWNAME.EXT

COMP C:\DIR1\FILENAME.EXT

C:\DIR2\NEWNAME.EXT

DEL C:\DIR1\FILENAME.EXT

REN C:\DIR1\FILENAME.EXT

NEWNAME.EXT

TYPE FILENAME.EXT

Copying Groups of Files

Copy files and subdirectories under DIR1

Copy files made on or after a date

Have XCOPY ask yes/no for each file

Duplicate a disk using two floppy drives

XCOPY C:\DIR1 D:\DIR2 /S

XCOPY C:\DIR1 A: /D:08-22-91

XCOPY C:\DIR1 A: /P

DISKCOPY A: B:

Duplicate a disk using same floppy drive

DISKCOPY A: A:

Note: VERIFY does not ensure an accurate copy. Always use COMP after COPY, and DISKCOMP after DISKCOPY.

MANAGING DISKS

Format a bootable floppy disk

Format a 360K floppy in a 1.2MB drive

Format a 720K floppy in a 1.44MB drive

Back up drive C:'s files and subdirectories to drive A:

Back up a specific directory's WK1 files

Back up files modified since last backup

Restore backed-up files and subdirectories

Restore certain files to their original directory

Restore files modified since last backup

FORMAT A: /S

FORMAT A: /4

FORMAT B: /N:9 /T:80

BACKUP C:\ A: /S

BACKUP C:\DIR1 *.WK1 A:

BACKUP C:\ A: /M /S

RESTORE A: C:\ /S

RESTORE A: C:*.WK1 /S

RESTORE A: C: /M

CHECKING AND CONFIGURING YOUR SYSTEM

Check the version of DOS

Check or correct system time

Check or correct system date

Clear the screen

Check disk and memory usage

Fix any file errors during a check

Check a particular file

VER

TIME

DATE

CLS

CHKDSK

CHKDSK /F

CHKDSK FILENAME.EXT

ADVANCED: DOS 5.0

How it works: DOS 5.0 provides several command line and memory management commands not present in other versions. You issue them like other commands, either from the DOS prompt or as lines in CONFIG.SYS or AUTOEXEC.BAT files. Two of them, DOSSHELL and EDIT, launch menu-driven programs.

UNDELETE AND UNFORMAT

These two commands undo other commands issued in error. Although they restore recently deleted files and recently formatted disks, there's no guarantee they can retrieve something once you've performed other operations on a disk.

UNDELETE C:\DIR1 /ALL
Restore any deleted files in DIR1

UNDELETE C:\DIR1 /LIST
List deleted files without restoring

UNDELETE C:\DIR1 /CONFIRM
Restore files on a formatted disk

UNDELETE C:\DIR1 /TEST
List files without restoring

Notes: If you format a disk using the /U switch (e.g., FORMAT A: /U), you cannot restore it using UNDELETE. Also, these instructions assume that UNDELETE.EXE and UNFORMAT.COM are in a directory listed in the most recently executed PATH command.

Fold Here

USING THE DOS SHELL

The shell program has three basic windows: a directory tree of the selected disk, a file listing for the live directory, and a main DOS command window.

<Alt> and first letter of menu name, or click with mouse

Select a command from a menu

click with mouse

Open menu, type highlighted letter, or click with mouse

Select a different drive

Toggle between windows

Select several consecutive files

Hold down **<Ctrl>** while clicking on file names, or highlight first file, **<Shift>**-**<F8>**, use cursor keys and **<Space>**

bar to select files, **<Shift>**-**<F8>**

Press **<Delete>**

Press **<F7>**

Press **<F8>**

Press **<F9>**

View contents

Copy selected files

Move selected files

Delete selected files

Display previous/next command

Move one character left/right

Move to beginning/end of command

Move one word left/right

Delete characters to beginning/end

Delete entire command

Toggle insert/overwrite

Display all commands in buffer

Display starting with character(s)

Display nth command

Display first/last command in buffer

EDITING DOS COMMANDS WITH DOSKEY

The DOSKEY command opens a buffer to store the commands you issue from the DOS prompt for you to reuse or edit.

<Cursor Up>/<Cursor Down>

<Cursor Left>/<Cursor Right>

<Home>/<End>

<Ctrl>-<Cursor Left>/<Ctrl>

<Ctrl>-<Cursor Right>

<Ctrl>-<Home>/<Ctrl>-<End>

<Esc>

<Insert>

<F7>

<F8>

<F9>

EDITING FILES WITH EDIT

DOS 5.0's EDIT is a character editor for text files that works with a mouse or the keyboard.

Start EDIT to edit filename

Open a menu

<Alt> and first letter of menu name, or click on menu name

Select a command from a menu

click with mouse

Open menu, type highlighted letter, or click on command, or press shortcut keys

Choose **Help** or press **<F1>**

Move one character/line at a time

<Cursor Up>, **<Cursor Down>**

<Ctrl>-<Cursor Left>/<Ctrl>

Move one word left/right

<Cursor Right>

<Home>/<End>

Scroll up/down one screen

Move to beginning/end of file

Select text

or press mouse button and drag across text

Move text

Select text, choose **File Cut** or press **<Shift>-<Delete>**, move to new location, choose **File Paste** or press **<Shift>-<Insert>**

Copy text

Select text, choose **File Copy** or press **<Shift>-<Insert>**

location, choose **File Paste** or press **<Ctrl>-<Insert>**, move to new location, choose **File Paste** or press **<Shift>-<Insert>**

Delete text

Select text, choose **File Clear** or press **<Delete>**

Choose **Search Find**, type text to find

Choose **Search Replace**, type text to replace, **<Tab>**, type replacement text

Choose **File Print**

Choose **File Save**, type file name

OPTIMIZING MEMORY USAGE

Install high memory driver

Add **DEVICE=DOS\HIMEM.SYS** to beginning of CONFIG.SYS file

Load DOS into extended memory

requires HIMEM.SYS

Add **DOS=HIGH** to CONFIG.SYS file;

requires HIMEM.SYS

Use 640K of extended memory

Add **DEVICE=DOS\EMM386.EXE**

to emulate expanded

486 processor and HIMEM.SYS

Use 512K of extended memory

Add **DEVICE=DOS\SMARTDRV.SYS**

for disk caching

Use 512K of extended memory

Add **DEVICE=DOS\RAMDRIVE.SYS**

as a RAM disk

Install Ramdrive in upper memory

RAMDRIVE.SYS 512 /a to

CONFIG.SYS after HIMEM.SYS

Load DOSKEY in upper memory

Add **LOADHIGH \DOS\DOSKEY.COM**

to AUTOEXEC.BAT; requires HIMEM.SYS

Check memory usage

MEM

Note: These instructions assume that HIMEM.SYS, EMM386.EXE,

SMARTDRV.SYS, RAMDRIVE.SYS, and DOSKEY.COM are in a directory

called \DOS on the boot drive.

NO CHARGE!

We Added...to DesignCAD 3D version 3.1: A Basic-like programming language entitled BasicCAD. We added new commands. We added hardware support for dozens and dozens of new devices. We made hundreds of overall internal enhancements!

We improved the manuals, the packaging and the speed.

How much extra did we charge? Nada. Nothing. Zip. No extra charge at all.

Oh, sure...our accountant said we could increase the price. Our lawyer said there was no legal reason not to charge more. A minister said we had no moral obligation to keep the same price!

So, why didn't we raise the price for DesignCAD 3D version 3.1?

Because...in the Great American Tradition we said

"Aw...What the Heck. Let's see the other guys beat this price!"

DesignCAD 3D version 3.1 sells for \$399.

Does this include everything? Yes. We include everything! The programming language, the hardware device drivers (more than 450), built-in shading capability, hidden line removal capability, solid-object modeling capability, translators to-and-from other file formats, are all included!

How can you afford to sell a program like this at such a low price?

This is our most often asked question. We have a simple answer. Volume. We sell thousands of these programs each month! If we were to charge thousands of dollars per copy (like our competitors) we would restrict our sales to the professional trades only.

By lowering our price we sell to professional architects and engineers as well as the ordinary individual! Many ordinary individuals purchase DesignCAD 3D for personal projects. Many people purchase DesignCAD 3D and perform CAD

Drafting at nights and on weekends as a second job!

People design "dream homes" and "widgets"

The uses are limited only by YOUR imagination!

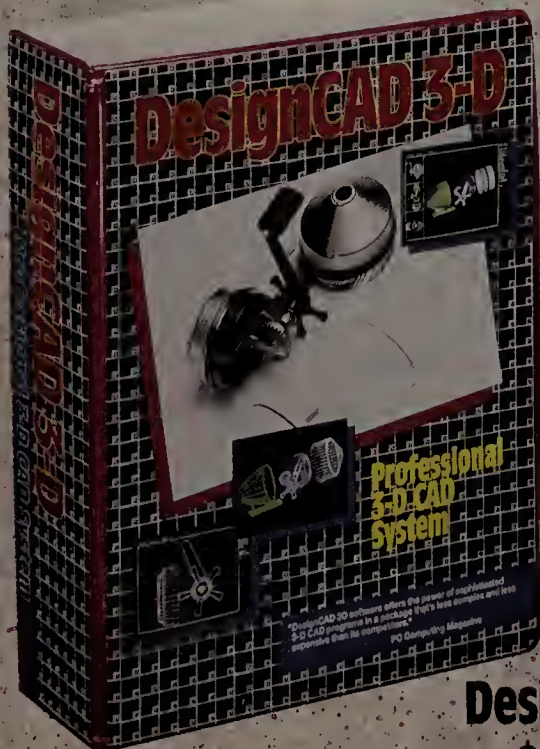

If there ever was a CAD program out to prove that AutoCAD, CADKEY, VersaCAD, and other \$3000 programs are overpriced, it's DesignCAD!

(MicroCAD News review)

**DesignCAD 3D
\$399**



December 11, 1990
DesignCAD 3-D, Version 3.1

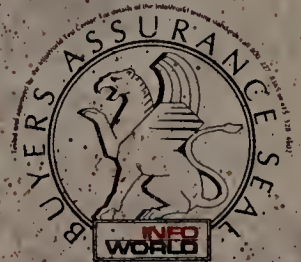

American

Small Business Computers, Inc.
One American Way • Pryor, Oklahoma 74361
(918) 825-4844 • FAX (918) 825-6359

IN EUROPE CONTACT:

American Small Business Computers, Europe
102 Rue La Fontaine • F75016 Paris, France
Phone 331 4520 2791 • Fax 331 452 06539

Remember - American Small Business Computers also sells a 2D version of DesignCAD. It costs only \$299!
Write or call for FREE brochures that will help you determine which program best suits your need.

Circle 306 on reader service card

So many columns, so little time.

We've taken two of our best selling Lotus add-ins—Sideways and P.D.Queue—and combined them into one money-saving package. So you can print as many columns as you want, and get back to work fast.

Sideways turns your text on its side as it prints. So you can make great-looking extra-wide spreadsheet printouts all in one piece—without staples, glue or tape.

And P.D.Queue, the add-in print spooler, gives you back control of your computer seconds after you start a printout. So you can get right back to work while P.D.Queue operates your printer in the background.

Now you can get both at one great price of \$129.95—a savings of over 25%.

Ask for "Sideways with P.D.Queue" at your software dealer or call us at 1-800-822-3865 ext. 228.

**Sideways[®]
printing
without
the wait.**

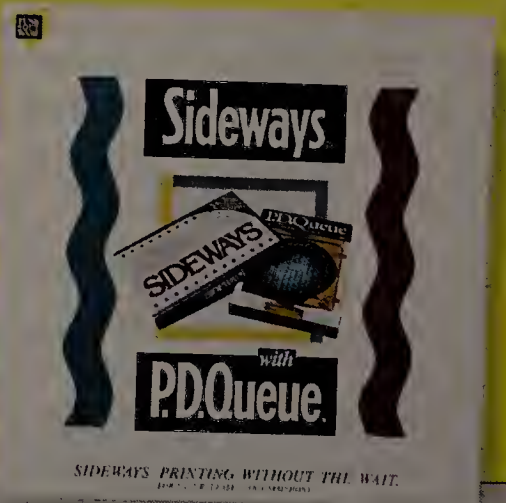

**FUNK
SOFTWARE**

FOR 1-2-3 RELEASE 2 AND SYMPHONY.

© 1991 Funk Software, Inc. Sideways and P.D.Queue are trademarks of Funk Software, Inc., 222 Third St., Cambridge, MA 02142.

Circle 60 on reader service card

Editor's note: You can make this trick even easier by placing the formula that might produce an error in a cell that's outside the range of what you see and print. For instance, if you put the formula that does the calculation in, say, AK12, you can use the formula @IF(@ISERR(AK12),"",AK12). This approach has two advantages: First, the math isn't done twice; second, you can edit the formula once—rather than twice—if it needs to be changed.

Brett Glass is a contributing editor for PC World.

Have a macro, batch file, short program, or general tip you're proud of? Star-Dot-Star pays \$25 to \$200 per tip used. Send your tips to Star-Dot-Star, PC World, 501 Second St. #600, San Francisco, CA 94107; Compu-Serve 74055,412; MCI Mail 179-3813; or 415/442-1891 (fax). We cannot acknowledge submitted materials. ●

PC WORLD PC WORLD PC WORLD

BACK ISSUES

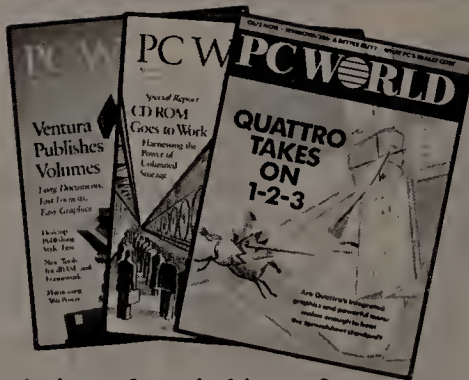

Is your PC World library complete? Or are you missing a few vital issues? Now's your chance to fill in the gaps with back issues of PC World—the best source for computing productivity. Each issue is available for \$6 per copy, while supplies last, including surface delivery via UPS. For orders of 12 or more issues, you pay just \$2.95 per copy.

For airmail delivery in the U.S. and Canada, please add \$6 per copy. For all other countries, back issues are \$20 per copy, including airmail delivery. Prepayment is required in U.S. dollars.

Simply enclose payment, specify the issues and quantities desired and send to :

PC World
Back Issue Department,
144 Townsend Street,
San Francisco, CA 94107

*Sorry, credit card orders cannot be accepted.
For Express Service call 1-800-395-5763.*

POWER TIP NO. 199

Easily Navigate Windows Subdirectories

Windows 2.xx's crude MS-DOS Executive has one saving grace: With it, you can quickly move up to a parent directory by pressing <Backspace>. With Windows 3.0, you can do the same thing in the File Manager and in file-oriented dialog boxes by repeatedly clicking the [...] at the top of the directory list. Depending on the complexity of your disk's directory structure, no more than three or four clicks should put you in the root directory. From there, you can find anything quickly.

*Richard Mann
Roy, Utah*

The Dawn of A New Era...

Operation Desert Storm ushered in a new era of combat technology: where high-tech air power represents unmatched military might. MicroProse salutes the changing face of modern combat with *Gunship 2000* — the dawning of a new age in simulation technology.

The only multi-helicopter, 3-D combat simulation on the market!



Gunship 2000 combines all the features you demand in a state-of-the-art simulation into one revolutionary package.

MICRO PROSE

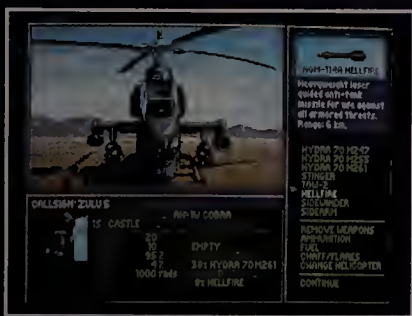

Multiple Weapons Systems To Command

Command a flight of five helicopters. Choose from Apaches, Cobras, Blackhawks, Longbows and more.



Groundbreaking 3-D Graphics

Improved Super 3-D Graphics generate terrain, especially low-level flight, with unprecedented detail. Multiple views of the action, inside and outside the cockpit.

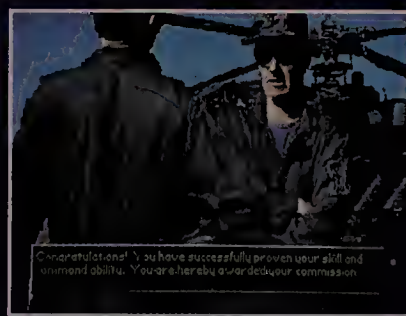

Scenarios Drawn From Today's Headlines

Select missions in Central Europe or the Persian Gulf.

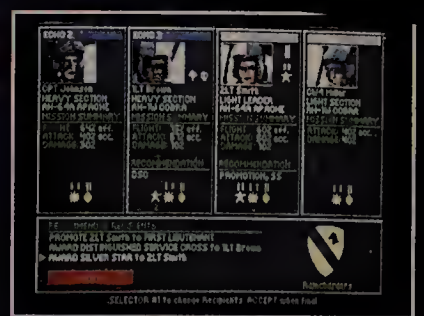

Non-Stop Action & Constant Challenge

Crew members have individual talents, and improve over time. Full campaign option.

For IBM-PC/Tandy/compatibles. For the latest information on release dates and availabilities, call MicroProse Customer Service at 301-771-1151, 9 am to 5 pm EST, weekdays. © 1991 MicroProse Software, Inc., 180 Lakefront Drive, Hunt Valley, MD 21030.

MICRO PROSE™
ENTERTAINMENT • SOFTWARE

LCX Includes

Built-In 8 Bit Video RAM - 256 Colors!
Built-In SCSI HD Port (attach up to 6 HD w/out more controllers)

Built-In 1.44 3-1/2" Sony Drive

Built-In Serial Port for Printing

Built-In Modem Port

Built-In Networking (AppleTalk standard, Ethernet optional)

Built-In Stereo Sound Chip & Microphone (attach voice messages to your documents!)

Includes DOS Mounter (auto mounts and reads & writes 3-1/2" DOS disks)

MAC LCX



MacFriends is Simply the Best!

Knowledgeable MacFriends 1000's of Friends in Field System Pre-Configured & Tested Unparalleled Support & Service

Accept no imitations. Those in the know don't do windows!

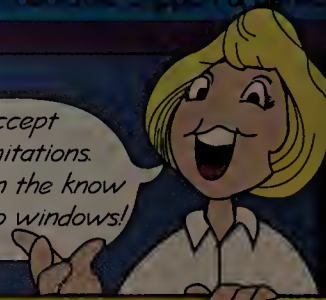

\$2988
Lease for just \$96/mo.



MacFriends is the complete source for all your Macintosh needs!

SIMPLY BETTER

Life can get pretty complicated, but most of the time it doesn't have to. Take, for instance, your computer needs. For a top-line business machine that will meet all of your needs you could buy a Dell system 333D. This is a 386 system with 100MB HD, 4MB RAM, VGA, all for the extraordinary price of \$4199. (As published in the June 1991 issue of PC WORLD.)

OR... you could buy a Macintosh LCX from MacFriends. Recent studies show that the LC outperforms 386s... from IBM and Compaq by 47% to 63%*... an amazing difference when it comes to your productivity. Thousands of programs that all work in the same simple, intuitive way.

Apple made computers faster and easier to use so you can be more productive. Now MacFriends brings all of this to you for less!

When you think about it, the choice is simple.

Mac Friends

Ask about **SPECIAL SOFTWARE OFFER!!**

800 338-9942

Call Toll Free Today! 24 HOUR QUICKFAX (503)255-0067 COMPUSERVE "GO MF"

Call today for a simple solution to all of your computing needs.



* An Ingram Laboratories study, published February, 1991. Ask for details when you call.

Apple, the Apple logo, and Macintosh are registered trademarks of Apple Computer, Inc. Compaq is a registered trademark of Compaq International Business Machines Corp. Dell is a registered trademark of Dell Computer Corp. IBM is a registered trademark of International Business Machines Corp. All other trademarks are the property of their respective owners.

DEVELOPER'S TOOLBOX

Two Great Programming Books

Brett Glass

The tools of the programmer's trade include more than just software and hardware; every codesmith needs a good library of reference books on languages, operating systems, data structures, algorithms, and program-building techniques. *Zen of Assembly Language* and *Undocumented DOS* are two books that belong on every PC programmer's bookshelf.

Michael Abrash's work, *Zen of Assembly Language Volume I, Knowledge*, starts off with the assumption that you are at least somewhat familiar with 80x86 assembly language programming, and it doesn't bother with explaining basics such as registers or addresses. Instead, it helps you to write superb, rather than merely adequate, assembly language code.

Abrash first introduces a set of routines for taking precise measurements of your program's execution time. He then delves into the secrets of the PC's architecture, showing why code that *seems* to be efficient on paper may not be in the real world. There are chapters on "cycle eaters" (hardware pitfalls that slow down programs), efficient (and inefficient) memory addressing modes, jump instructions, and optimizing for the more advanced 386 and 486 processors.

Zen was originally intended as the first of two or three books on advanced assembly programming. At this date, however, only one volume is out, and no others are on the drawing board. This is a pity; Abrash's examples and advice are eminently practical, and his keen senses of humor and irony make the book fun as well as instructive. Why "Zen"? Says Abrash, "Zen is a technique that brings intuition and nonobvious approaches to bear on difficult problems and puzzles." Highly

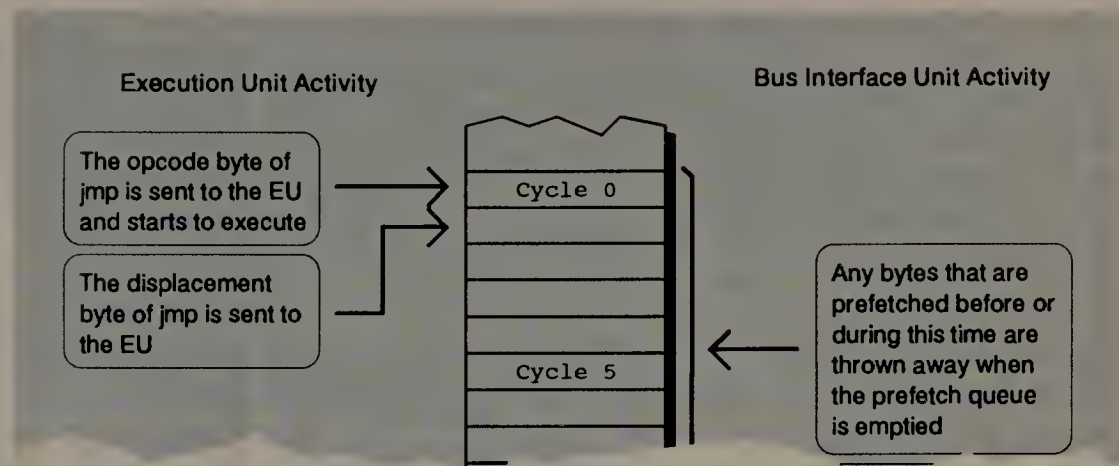

A figure from "*Zen of Assembly Language*" shows how you can speed a program by fetching one instruction while another is executing.

recommended.

Undocumented DOS is an excellent text for anyone who's curious about the innards of MS-DOS, and a must for anyone who writes TSRs, network redirectors, or other programs that work with DOS internals. Written by half a dozen knowledgeable authors, including editor Andrew Schulman, *Undocumented DOS* covers "the body of functions and data structures that can reasonably be considered part of DOS, yet are either unmentioned in the documentation or marked 'Reserved.'"

The first two chapters discuss the reasons for, and logistics of, using undocumented DOS features. The next few chapters cover DOS's data structures and contain fascinating and enlightening discussions of the way DOS allocates resources, uses files, and connects to networks and non-DOS file systems (such as CD ROM drives). If you wish to do advanced memory management, add a new kind of storage device, or create a network driver for DOS, this information will help you do the job right.

Subsequent sections cover features that let you write TSRs, command interpreters, and debuggers. The last chapter gives you a script-driven, event-driven debugger—in a combination of C and assembly—that shows you how

DOS and its utility programs access undocumented features.

Undocumented DOS is a collaborative work that draws on years of collective experience and experimentation as well as on hundreds of pages of on-line discussion. Before this book was published, the only way to gather this information was to disassemble DOS yourself. Now, at last, programmers can spend less time reinventing the wheel and more time producing useful products.

Have a favorite programming tool you'd like to see discussed here? Send suggestions to my Internet E-mail address, rogue@well.sf.ca.us, reachable via CompuServe, MCI Mail, Internet, and Usenet. ☺

WHERE TO BUY

Zen of Assembly Language Volume I, Knowledge

Michael Abrash
Scott, Foresman and Company
Glenview, IL
1990, \$29.95
ISBN: 0-673-38602-3

Undocumented DOS

Andrew Schulman, Raymond J. Michels, Jim Kyle, Tim Paterson, David Maxey, Ralf Brown
Addison-Wesley Publishing Co., Inc.
Reading, MA
1990, \$39.95 (disks included)
ISBN: 0-201-57064-5

CATALOG

PC WORLD

Shop *The PC World Catalog* for fast solutions to your PC needs.

HARDWARE

■ Accessory Boards	245
■ Bios Chip	245
■ CD ROM	245
■ Communications/Modems	245-246
■ Computer/Systems	246
■ Disk Drives	246
■ Laptops	246
■ Peripherals	246-247
■ Plotters	247
■ Tape Back-Ups	247

■ Graphics	254-255
■ Health	255
■ Inventory Control/Management	255
■ Languages	255
■ Mailing Programs	255
■ Maintenance Management	255
■ Medical	256
■ Music	256
■ Networking	256
■ Public Domain/Shareware	256
■ Real Estate	256
■ Security	257
■ Statistics	257
■ Surveys	257
■ Training	257
■ Utilities	257

MISCELLANEOUS

■ Accessories	248
■ Bar Coding	248-249
■ Business Opportunities	249
■ Catalogs	249
■ Computer Insurance	250
■ Data/Disk Conversion	250
■ Data Recovery	250
■ Disk Copy Service	250
■ Disks	250
■ Security	250
■ Slides	251
■ Supplies	251

ADVERTISING SALES STAFF

Sandra Wade - *Catalog Manager*
 Duane Hampson - *Eastern Account Manager*
 Elizabeth Maffly - *Catalog Coordinating Manager*

ADVERTISING RATES & INFORMATION

The *PC World Catalog* serves as a cost-effective monthly meeting place for advertisers and volume purchasers. *Our readers don't want to shop, they want to buy!* And your message can reach them in two formats—display or text. Both are arranged by product category for easy reference.

Display ads are sold by the column-inch (2-inch minimum). You must supply camera-ready type and artwork. Standard red is available as a second color.

Text ads are sold at a minimum three-time rate of \$560 per issue for a total of \$1,680. You supply copy. We set type.

For further information regarding the *Catalog*, space closings and material deadlines, please call Toll-Free 800/435-7766. Within California, call 800/435-7760.

PC World
 501 Second Street
 San Francisco, CA 94107

PcW PCW Communications, Inc.
 An IDG Communications Publication

SOFTWARE

■ Accounting	251-252
■ Business Applications	252
■ Church Applications	253
■ Communications	253
■ Construction	253
■ Database Publishing	253
■ Data Entry	253
■ Educational	253
■ Entertainment/Games	253-254
■ Financial	254
■ Flow Charting	254
■ Genealogy	254

CATALOG

PC WORLD

Shop The PC World Catalog for fast solutions to your PC needs.

HARDWARE Accessory Boards



BLAST YOUR MESSAGE THRU

VOICE MAIL CALL PROCESSING TELEMARKETING

Let Powerline™ transform your PC/XT/AT/386 into a multi-line voice processing command center. Have your computer intelligently process your sales, inquiries and messages. Complete package.

Single Line (Bigmouth) .. \$295.00
Multi-Line .. \$895.00

(Developer/OEM packages available)
VISA - MC - AMEX - COD
Call: (415) 522-3800
FAX: (415) 522-5556
TALKING TECHNOLOGY, INC. TTI
1125 ATLANTIC AVENUE, ALAMEDA, CA 94501

CIRCLE 521 ON READER SERVICE CARD

Bios Chip

AWARD BIOS ROM UPGRADES

Upgrade your IBM XT, AT or Compatible with a new AWARD BIOS ROM. Add

high density floppies, 101 keyboards, etc.

Call for FREE Catalog. **KOMPUTERWERK**

851 Parkview Blvd.,
Pittsburgh, PA 15215
Orders (800) 423-3400
Tech. (412) 782-0384

CIRCLE 478 ON READER SERVICE CARD

ROM BIOS Upgrades

AMI & PHOENIX. Upgrade your IBM PC, XT, AT, or compatible, 386sx & 386 also. Supports 2 user defined hard drives, expanded hard drive tables 101/102 KB, 360, 720, 1.2 & 1.44 floppies, Complete set-up In ROM, All Video, Windows 3.0.

*ROM diagnostics: AMI 286&386. Reasonable prices & full 30 day money-back Guarantee! Don't Settle For Less-Call us.

ADVANCED SOFTWARE
4 1/2 Marlboro Road Suite 2R
Derry, NH 03038
800-835-2467 603-432-1532

CD Rom

CD-ROM



Countries of the World

The full text of over 100 study books including business statistics, maps, flags, national anthems (sound), & more, the ultimate international reference! \$495

Pioneer Six Pack Bundle

Get 6 great discs: • U.S. History • Countries of the World • Birds of America • Sherlock Holmes • Shakespeare • Software Potpourri Only \$389 6 Pack and Minichanger ALL FOR ONLY \$1489

CD-ROM BUNDLE

Get a CD-ROM Drive and any 5 of these discs:
• Microsoft Bookshelf • U.S. History on CD-ROM
• Illustrated Encyclopedia • CIA World Fact Book • Golden Immortal • Between Heaven & Hell II • Shakespeare • Sherlock Holmes
• Software Potpourri/Bible ALL FOR ONLY \$597

CD-ROM Drives

NEC CDR-36, 73, or 83 newest models from 489 Chinon, Hitachi, Denon, Philips & Sony in-stock

CD-ROM Titles

Between Heaven & Hell II practical/perverse 99
McGraw-Hill Ref. set 100,000 terms 245
Grollier's Encyclopedia 20 vol. PC & Mac 289
U.S. History on CD-ROM 107 books & images 395
Speed Dial Entire U.S. Yellow Pages 399

MORE! Over 300 different titles
Money back guarantee Free tech support
GUARANTEED LOWEST PRICES



Bureau of Electronic Publishing, Inc.
Dept. A • 141 New Road, Parsippany, NJ 07054
Fax # 201-808-2676

Call: 1-800-828-4766 orders only
201-808-2700 information

CIRCLE 540 ON READER SERVICE CARD

ROM BIOS UPGRADES

For Your IBM or Compatible — A New BIOS Upgrade Will:
• Support Windows 3.0 • Support 360K, 720K, 1.2 MB & 144 MB Floppy Drives • User defined hard drive types • Supports VGA • Novell & Netware compatible • Expanded hard drive table • Enhanced 101/102 keyboard • 100% IBM compatible • Complete documentations • Latest version • Complete set up in ROM.

Dealer/Distributor Inquiries Welcome
Authorized Award Software, Inc. Dist

1-800-800-BIOS

800-800-2467 508-686-6468 Fax: 508-683-1630



599 CANAL STREET, LAWRENCE, MA 01840

CIRCLE 467 ON READER SERVICE CARD

BUY WITH CONFIDENCE

CATALOG
SHOP PC WORLD

CD-ROM 1-800-843-9497

Save over \$1400 on CD-ROM titles!

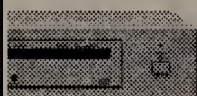

NEC Intersect CDR-73 Bundle (AT/XT-300ms): Buy the NEC

Intersect CDR-73 bundled with the 8 CD-ROM titles listed below for only \$950. Save \$1400! A retail value of \$2,366. #A1-1978, \$950

NEC Intersect CDR-36 Bundle (AT/XT - 500ms) w/the 8 CD-ROMs below. Save \$1300! #A1-1977, \$850

1 The Illustrated Encyclopedia

1000s of facts at your fingertips instantly! Over 33,000 articles, 1,500 full color illustrations and photos. 21 volumes.



2 The Reference Library

Access volumes of data and reference respected sources including *The New York Public Library Desk Reference*, *Webster's New World Dictionary™*, and more!



3 The World Atlas
"The World Atlas is the winner" *BYTE Magazine*. It's an almanac, world factbook, and atlas all in one.

Access over 240 reference, statistical, and topographical maps!

4 The Bible Library
9 Bibles and 20 reference works.

5 Shakespeare on Disc
Full text in American and Queen's English versions.

6 Sherlock Holmes
Complete text including *The Medical Casebook of Dr. Doyle*, linoleum block prints, and more.

7 Birds of America
The complete 1840 edition plates and text, as well as bird calls.



8 The Game Pack
Five spectacular games including the award-winning strategy game, *The Chessmaster 2000*. Also includes *Bruce Lee Lives*, *Beyond the Black Hole*, *Gin King/Cribbage King*, *Life & Death*.

EDUCORP Computer Services
1-800-843-9497
Info: 619-536-9999 FAX: 619-536-2345

CIRCLE 414 ON READER SERVICE CARD

Communications/ Modems

COMMANDER by cybex

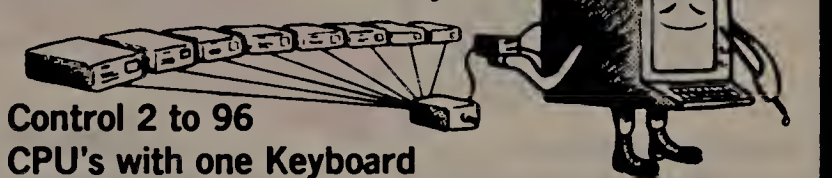

Control 2 to 96 CPU's with one Keyboard and Monitor up to 250 ft. away.

- IBM PC, XT, AT, PS/2 and 100% Compatibles
- Available for MDA, CGA, EGA (TTL) and VGA (Analog) Monitors
- Unattended Booting

CYBEX CORPORATION
2800 H. Bob Wallace Avenue
Huntsville, AL 35805
(205) 534-0011

CIRCLE 469 ON READER SERVICE CARD

CATALOG

PC WORLD

Shop The PC World Catalog for fast solutions to your PC needs.

Communications/ Modems



This 4½ Hour VHS Video Tape Course –

“How To Install A NOVELL® Network”

Will teach you in plain English all the basics required to install a Novell Network. Topics include: Network Boards, Cabling, File Servers, Hard Drives, Disk & Diskless Workstations, Software Installation, Network Management, Multi-User Applications, etc.

For Orders Call 1-800-654-1138

Tech-support
818-905-1262

Introductory Price

\$99⁹⁵ Plus \$5
Shipping & Handling

FAX 818-905-1292



Vogue Video Productions



16250 Ventura Blvd., #202, Encino, CA 91436

CIRCLE 513 ON READER SERVICE CARD

Disk Drives

**BACKPACK.
IT'S A DRIVE OF A
DIFFERENT COLOR.**



Add a diskette drive without horsing around inside your computer — just plug Backpack into your parallel port! Connect your printer to the Backpack drive. No tools. No hassles. No interface cards. Backpack works with IBM and compatibles including PCs, XTs, ATs, PS/2s, PS/1s, and laptops. It's available in 5.25"

and 3.5" and comes complete with everything you need. So don't horse around inside your computer, add an external drive the easy way—plug in a Backpack! Hard Disk models and tape backup available soon.



MicroSolutions
Computer Products

132 W. Lincoln Hwy., DeKalb, IL 60115
815-756-3411 Fax: 756-2928

CIRCLE 536 ON READER SERVICE CARD

Computer Systems

COMPUTERS

BEST PRICE. BEST SERVICE. BEST QUALITY

386SX16 286-12

40MB VGA color 40MB VGA color

\$1275 \$995

NAME BRANDS FOR LESS Call For Items Not Listed

ALR	EVEREX	MAXTOR	SEAGATE
APPLE	IBM	MICROSOFT	SONY
AST	INTEL	MITSUBISHI	TOSHIBA
CONNER	IRWIN	NEC	WANGTEK
CYRIX	LOTUS	OKIDATA	ZENITH

MICRO BASE TO ORDER CALL TOLL FREE

800-345-4479 (408)727-6276 CA
(408)727-7307 FAX

3000 Scott Blvd Suite 203 Santa Clara Ca 95054

CIRCLE 423 ON READER SERVICE CARD

**BUY
WITH
CONFIDENCE**



**SHOP
PC WORLD**

Laptops

Peripherals

LAPTOPS

800-741-LAPS

TOSHIBA COMPAQ
ALTIMA SHARP
EPSON T.I.

Much More...

We carry a full line of Modems,
Memory Upgrades, Exp. Chasis, Etc...

LAPTOP CITY

3399 N.W. 72 AVE. #106
MIAMI, FL 33122

CIRCLE 421 ON READER SERVICE CARD

**VDT RADIATION WARNING
DON'T SIT TOO CLOSE!**

The EPA says "There is reason for concern" and advises "prudent avoidance" of electromagnetic fields. Unfortunately, many people just don't realize just how far VLF and ELF radiation extends from computer displays. With Safe's affordable digital gauss meters, you can measure magnetic field strengths.

List \$250. Sale \$149.95.
1-800-222-3003. Ask for Ext. 510.

**SAFE TECHNOLOGIES
CORPORATION**

145 Rosemary St., Needham, MA 02194-3258

CIRCLE 555 ON READER SERVICE CARD

Tandy Computers

Nationwide Sales - Guaranteed Best Prices

The Canfield Company

1-800-633-0197

A **Radio Shack**® Dealer

400 Pennsylvania
Hokon, KS 66436

1-913-364-2171
FAX 913-364-4311

CIRCLE 541 ON READER SERVICE CARD

CATALOG G

Shop *The PC World Catalog* for fast solutions to your PC needs.

ANNOUNCING: AN ADVANCE IN 9-TRACK OF VERY SMALL PROPORTIONS:



Overland Data's OD3210, the smallest autoloading 9-track tape drive in the world.

While everyone else is downsizing and simplifying computers and peripherals, 9-track tape drive manufacturers have somehow managed to buck this trend with drives that are huge and heavy or awkwardly manual loading.

Too bad for them. Introducing the OD3210, designed and built by Overland Data to bring 9-track into the modern office. It's incredibly compact. Portable. Whisper quiet. Uses only 45 watts. And it's extremely reliable. No other drive has fewer moving parts. Best of all, it's surprisingly affordable.

The OD3210 comes with a two year warranty, expert toll-free support, and the ODI Special Service Program. So call us. And find out why some of the best advances are the smallest ones.

1-800-PC9-TRAK
(1-800-729-8725)

Bus. Phone: 1-619-571-5555 • FAX: 1-619-571-0982

 **OVERLAND DATA**
San Diego, CA

CIRCLE 531 ON READER SERVICE CARD

MAINFRAME 9-TRACK for MICRO's

6250
3200
1600
800

*Fastest,
Most Reliable
Drives made
for Micro's*

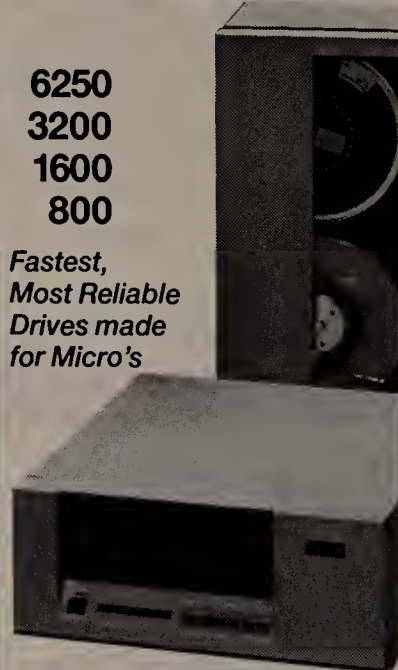

800/842-0708

**TDX
PERIPHERALS
TDX**

HAUPPAUGE, NY • 516/273-5900

CIRCLE 497 ON READER SERVICE CARD

Plotters

Affordable, Large Format Plotters

Now, you don't need a big budget to get quality and performance from your plotter. That's why Zericon's large format plotters are becoming so popular.

Our D size starts at \$1695 and our A-E model is only \$2995 direct from Zericon.

Call us today for a free sample plot and info about our money back guarantee. 40491 Encyclopedia Circle, Fremont, CA 94536. In CA (415) 490-8380 FAX: (415) 490-3906

**No Risk
Money Back
Guarantee**

\$1695. - \$2995.
Factory Direct Pricing

(800) 727-8380

CIRCLE 532 ON READER SERVICE CARD

Tape Back-Ups

9-Track Tape For Your IBM PC/XT/AT/PS-2™



Read 1600 or 6250 bpi 9-track tapes from a micro, mini or mainframe in EBCDIC or ASCII as mirror image or by individual files.

Use the 2000 PC™ for disk backup, data interchange or archival storage.

PC/XT/AT/PS-2 are trademarks of IBM. 2000 PC is a trademark of Digi-Data.



DIGI-DATA CORPORATION
6500 Dorsey Run Road
Jessup, MD 20794-9990
(800) 782-6395
FAX (301) 498-0771
... First In Value

CIRCLE 428 ON READER SERVICE CARD

9-Track Tape Subsystem



Now you can exchange data files between your IBM PC/XT/AT and any mainframe or mini-computer using IBM compatible 1600 or 6250 BPI 9-Track tape. Unit can also be used for disk backup. Transfer rate is up to 4 megabytes per minute on PCs and compatibles. Subsystems include 7" or 10½" streaming tape drive, tape coupler card, cables and software.

QUALSTAR★

9621 Irondale Avenue
Chatsworth, CA 91311
Telephone: (818) 882-5822

CIRCLE 527 ON READER SERVICE CARD

IF YOU CAN'T TRY IT, DON'T BUY IT

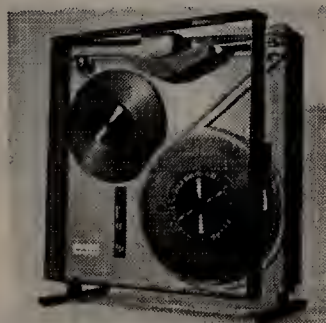

TapeWare is a new, exceptionally friendly user interface for most popular 9 track tape controllers. No more typing filenames, botched back-ups or one-at-a-time file transfers. Call for FREE Demo Disk. See for yourself. We also supply 9 track hardware and software up to 6250 BPI which includes TapeWare. Compare before you buy.

AKSystems Inc.

818/709-8100 (v) 818/407-5889 (fax)

CIRCLE 584 ON READER SERVICE CARD

Never buy another ribbon!

Over 150,000 sold!!



MacInker™, the Automatic Ribbon Re-inker, re-inks any PC printer ribbon or typewriter (black & color) for 5 cents. Lubricating ink cools printhead, extends its life and yields better-than-new printout. Avge. re-inkings per cartridge: 60-100. **Universal MacInker** (spec. cartridge or spool) \$75.00. **Epson or Imagewr.** \$45.00. Adapters available for any multicolor cartridge, \$40.00. We have a complete range of black, color, heat transfer, special ink cartridges. Satisfaction or 30 day refund. Free key-beeper-flashlight for orders >\$100.00. **Order toll free** or call to get full information.

(800) 547-3303 **Computer Friends**
14250 Science Pk. Dr.
Portland OR 97229
tel. (503) 626-2291
fax (503) 643-5379

Major credit cards accepted. PCs from National Accounts accepted. Shipping \$5.00 cod add \$3.30

CIRCLE 483 ON READER SERVICE CARD

CATALOG

PC WORLD

Shop The PC World Catalog for fast solutions to your PC needs.

MISCELLANEOUS/ Accessories

CUSTOM KEY CAPS

IBM®,
Macintosh®,
Key Tronic®,
Cherry®, & More

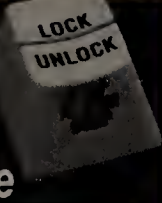

- Key imprinting to your color specs
- Keytop Labels for most popular software
- Templates for most popular software
- Custom Templates to your specs
- Custom Labels to your specs
- Relegendable Keys—IBM®, Cherry®, Key Tronic®, Wyse®
- Flexshield™ Keyboard Protectors

Express Turn-around services on Custom!

Call for your FREE CATALOG!

Toll Free
800 937-1337

602.634-7515 • FAX: 602.634-4620

Hooleon CORPORATION P.O. B. 230, Dept. PCWD
Cornville, AZ 86325

CIRCLE 518 ON READER SERVICE CARD

FREE GLOBAL CATALOG

164 page guide to computer furniture, supplies and accessories

Dial Toll-Free
1-800-8-GLOBAL

GLOBAL
COMPUTER SUPPLIES

11 Harbor Park Dr., Dept.
Port Washington, NY 11050

CIRCLE 508 ON READER SERVICE CARD

Mouse Pads

Custom Printing Available.

Cloth: 13 Colors

Size: 8 x 7 1/4 8 x 9 1/2 8 1/2 x 11

12 Pads 3.25 3.50 3.75

72 3.00 3.25 3.50

144 2.85 3.00 3.25

PLASTIC: Blue, Platinum, Gray, Red & Black. Size: 8 1/2 x 11.

12 Pads 6.50 36 6.00

72 5.75 144 5.25

ASK US ABOUT OUR WRIST RESCUE!

Precision Line Inc.

14505 21st Ave. No. Ste. 206

Plymouth, MN 55447

612-475-3550, 1-800-328-0077

Computer RIST- REST™

Have you "had it" with tired, aching hands, fingers or wrists from key-boarding? Avoid possible Carpal Tunnel Syndrome (CTP). Order RIST-REST™ for ONLY \$12.95 plus S/H\$1.50. An unbeatable price for a top quality product. Dealer inquiries invited. Call TODAY for additional details or to place your order.

SANTIMAN ENTERPRISES

P.O. Box 903433

Palmdale, CA 93590

800-835-8688 or 805-266-0642

Bar Coding

PC WAND BAR CODE READERS

MORE FEATURES
MORE AFFORDABLE



NEW IMPROVED

Starting at \$279 with wand! • Transparent operation. • No software required • PC, XT, AT, Mac, PS2, others. Look into our our full line of reliable, competitively priced readers, keyboard and serial wedges, portable data collectors, multi-drop readers, wands, laser scanners, mag stripe readers, and bar code printing software • OEM and reseller discounts. We provide solutions to systems! Custom application software for Data Collections available. Call for details.



INTERNATIONAL TECHNOLOGIES & SYSTEMS CORP. ITS

655-K North Berry St., Brea, CA 92621

(714) 990-1880 • FAX (714) 990-2503

13 Welwyn Ct., Richmond, VA 23229

(804) 741-6725

CIRCLE 501 ON READER SERVICE CARD

VARIANT MICROSYSTEMS BAR CODE READERS DELIVER WAND/ LASER/ MAGNETIC CARD CONNECTIVITY

- Keyboard wedges (Internal/External) for IBM PC/XT/AT, PS/2 and portables.
- RS232 wedges for WYSE, Link, Kimtron terminals
- Auto-discriminate between codes 3 of 9, UPC, EAN, 12 OF 5, Codeabar, Code 128
- Interface with wands, Symbol Technologies, Metrologic and Photographic Sciences lasers
- Bar code and label printing software
- Full two year warranty
- 30 Day Money Back Guarantee
- Extensive VAR/Dealer Discounts



VARIANT MICROSYSTEMS
3140 De La Cruz Blvd.,
Suite 200
Santa Clara, CA 95054
Phone (408) 980-1880
Fax (415) 623-1372



CIRCLE 468 ON READER SERVICE CARD

LABELING SOFTWARE

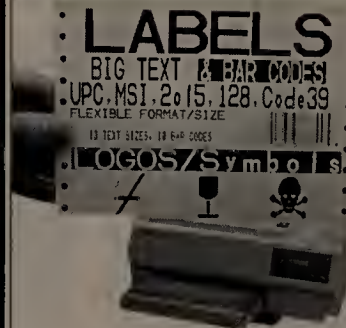

- **LABELS**
- BIG TEXT
- UPC, MSI, 2 of 5, 128, Code 39
- FLEXIBLE FORMAT/SIZE
- 13 TEXT SIZES, 18 BAR CODES
- LOGOS/Symbols
- For Epson, Oki, IBM, and LaserJet
- Flexible design. Any Format or size.
- On-Screen Label Design, WYSIWYG
- 16 text sizes — 3" reads at 100'
- Bar codes: 2of5, 128, UPC/EAN AIAG, MIL-STD, ZIP+4, & Code 39
- Auto-incrementing. File input.
- Logos, symbols — from scanners.
- Reversals, color, soft fonts.
- Powerful, Versatile, Fast, Easy!
- Rotatable, shadable, scalable fonts from 1" to 13" on LaserJet III
- Above label printed with LabelRIGHT™ — \$279
- Other menu driven programs from \$129. SCO/UNIX — \$199

Portable Readers

- Battery operated reader
- Simple, powerful, 64K memory
- Bar code or keyed input
- Codabar, 2of5, UPC/EAN, Code 39
- Easily programmable prompts
- Uploads via RS-232 or keyboard
- Doubles as non-portable reader
- Wand or laser input
- Complete with wand — \$849



Bar Code Readers

for PC, XT, AT, PS/2, Mac and all RS-232 Terminals

- Attaches as 2nd keyboard
- No software changes
- 2of5, UPC/EAN, 128, MSI, Code 39
- Magstripe, laser, or wand input
- Complete with steel wand — \$399

FLEXLINES MAGAZINE
Outstanding Price And Function

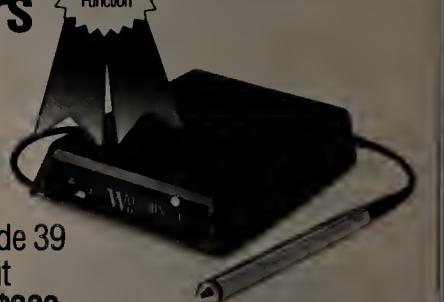

2 Yr. Warranty on Readers
Direct from manufacturer
30 day \$ back guarantee!

WORTHINGTON

DATA SOLUTIONS

417 Ingalls Street
Santa Cruz, CA 95060

408-458-9938

800-345-4220

BAR CODE READERS AMERICAN MICROSYSTEMS

2190 A Regal Pkwy. • Eules, Texas 76040 • (817) 571-9015

FOR PC, XT, AT, PS/2 & TERMINALS:

- No software changes required
- Data appears as keyboard input
- Reads Code 39, 1-2of5, UPC/EAN, Codabar, 128, 93, 11, MSI/Plessey
- Auto-discriminates between codes
- Accepts WAND, SLOT, CCD, LASER, MAG STRIPE

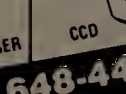

BAR CODE PRINTING SOFTWARE:

- For Epson, DKL, IBM, Dot Matrix and HP LaserJet Printers.
- Prints Code 39, 1-2of5, UPC/EAN, Codabar, 128, 93, 11, MSI/Plessey
- Easy To Use

(800) 648-4452 • FAX: (817) 685-6232
30 Day Money Back Guarantee
One Year Warranty

CATALOG

PC WORLD

Shop *The PC World Catalog* for fast solutions to your PC needs.

TKS Builds a Better Bar Code Reader!

- Excellent first read rate
- Works with any program — no software required
- Plastic wand is rugged, lightweight and comfortable, even after hours of use (stainless steel wand also available)
- Durable extruded aluminum case
- Reads all major bar code types
- 30-day money-back guarantee

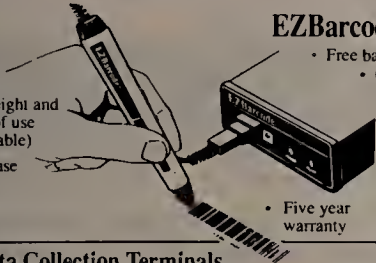

EZBarcode PC-WEDGE II

- Free bar code printing utility included
- Complete with wand, it's

only **\$289!**

RS-232 version \$319
Macintosh version \$309
Stainless steel wand . add \$60
Mag stripe option . add \$100

• Five year warranty

Portable Hand held Data Collection Terminals

Easy-to-use application generated software included free

- PHT-34: Alphanumeric keypad, bar code wand, 128K memory . . \$1095
- PHT-60: Graphics touch-sensor LCD display, programmable function keys, bar code wand, RAM card port, 256K memory . . \$1795

Bar Code Printing Programs . . . \$149 each

Print Code 39, UPC, EAN, 2 of 5 on dot matrix or Laser Jet printers

- EZBarcode II - Keyboard or text file input, incrementing, on-line help
- dBARCODE - Prints bar codes from within dBASE
- EZRes - Memory resident bar code printing program

Touch Panel!

PHT-34 ▶

◀ PHT-60

TimeKeeping Systems, Inc.

1306-W East 55th Street • Cleveland, Ohio 44103 • Phone: (216) 361-9995 • Fax: (216) 361-0030



Bar Code Reader for PC, XT and AT

\$295

- Reads all popular bar codes
- Rugged aluminum housing
- No software/hardware modifications
- Stainless-steel wand
- 2-Year Warranty (one year for wand)
- MS-DOS Bar Code Print Software \$150
- Works with any program or operating system
- Withstands 6ft. Drop to Concrete



Portable Bar Code Reader for PC or Macintosh

\$645

- 36-Key Alphanumeric Key-Pad
- 32K RAM expandable to over 1 Meg
- Easily programmable screen prompts
- Complete with Hewlett-Packard wand
- Data stored in ASCII Text Format
- Communications Software and Cable Included



800-526-5920

Call Toll-Free U.S. & Canada

FAX: 415-856-3843

All TPS products carry 30-Day Money-Back Guarantee



Electronics 4047 Transport Street, Palo Alto, CA 94303 Phone: 415-856-6833

CIRCLE 522 ON READER SERVICE CARD

Mag-Tek Magnetic Stripe Card Readers

- Attaches to a computer keyboard or to any flat surface
- LED light provides continuous reader status
- Works with Mag-Tek Encrypting and Non-Encrypting PINPads
- For use with AT/XT and PS/2 model computers
- RS-232 and PC Keyboard Wedge versions available

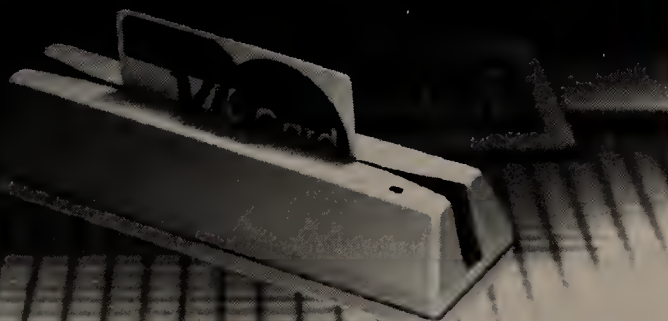

RS-232 Reader

Interfaces easily with a host computer or ASCII terminal via the RS-232 serial port.

User can set parameters such as mode of operation (buffered or unbuffered) baud rate, etc. via the switch block settings.

CIRCLE 437 ON READER SERVICE CARD

Mag-Wedge Reader

Connects between the PC and PC keyboard. Transmits magnetic stripe card data to the PC as if it were key entered.

MAGTEK

20725 South Annalee Ave.
Carson, CA 90746
Phone: (213) 631-8602
Fax: (213) 631-3956

Business Opportunities

Catalogs

Software Dealers Wanted

Perfect Care program needs dealers. We teach how to sell, install & support our medical billing sys. to MDs...a profitable high growth service industry. We offer:

- Training & continuous support
- 7 yrs of medical computer exp.
- Protected territories nationwide.

Ted Itzkowitz

STI Computer Services, Inc.
251 W. DeKalb Pike-Concord 107
King of Prussia, PA 19406
215/768-9030

Own a Billing Service!

Great part time PC based business. Provide invoicing and accounts receivable services to small businesses. \$500-\$5000 income monthly. \$289 for complete set-up incl; Software, proven marketing plan, promotional materials, and ongoing support.

Bluejay Systems
2579 Clematis Street
Sarasota, FL 34239
(813) 365-3357

IBM PCjr Specials

Full line of IBM PCjr hardware accessories including: Memory expansions, Second floppy drive, Hard drives, Cables, Larger keyboards, Modems, Printer expansions, Manuals, & software. Many more items are available. Send today for the complete catalog.

Computer Reset
Dept. PW, Box 461782
Garland, TX 75046-1782
214/276-8072

FREE Computer Catalog

OVER 4000 SOFTWARE, HARDWARE, ACCESSORIES AT DEEP DISCOUNTS.

JOIN OUR FREQUENT BUYERS PROGRAM AND WIN FREE GIFTS. ASK US ABOUT OUR LOWEST PRICE AND MONEY BACK GUARANTEES. [AD # A06C] **the computermill**

1.800.800.5592
FAX 415.623.7403
9 AM - 6 PM, MON - FRI, PST

CIRCLE 499 ON READER SERVICE CARD

CATALOG G

Shop *The PC World Catalog* for fast solutions to your PC needs.

Computer Insurance

SAFEWARE

Insure your computer. Safeware provides full replacement of hardware, media & purchased software. As little as \$49 a year provides comprehensive coverage. With our blanket coverage, no lists of equipment are needed. One phone call does it all! Call 8am to 10pm EST (Sat 9 to 5)

Safeware, The Insurance Agency
2929 N. High St., PO Box 02211
Columbus, OH 43202
800/848-3469, 614/262-0559

Data/Disk Conversion

TAPE/DISK CONVERSIONS



Conversion services to or from over 2000 computer systems:

- Magtapes • Mini Computers
- Micro Computers • Typesetters
- Word Processors

CALL THE INDUSTRY LEADERS

PIVAR
COMPUTING SERVICES, inc.

800-CONVERT

165 Arlington Heights Rd #W
Buffalo Grove, IL 60089

SCANNING any font or typestyle disk or tape. **CONVERSION** **DUPLICATION** any size, any quantity

- Data Entry
- Custom Programming
- Data Management
- Bar Code Conversion

(708) 858-4566



We perform miracles!

MEDIA CONVERSION CORP.

Free Tests and Quotations—24 Hour Turn-Time



CIRCLE 462 ON READER SERVICE CARD

RGA DATA CONVERSION CENTER

Tape, disks, micros, minis, mainframes, word processors, typesetting, and more...

- Database Management
- IBM 4381 on premises
- Conversions to/from all systems
- Hundreds of conversion programs
- Keying, labels & laser letters
- Carrier route & Qualifications

(212) 779-7667

Ralph Garner Associates, Inc.
99 Madison Avenue, New York, NY 10016
Professional services since 1967

CIRCLE 408 ON READER SERVICE CARD

CONVERTING YOUR DISKETTES?

ENTRUST THEM TO US

2500 Word Processor & Computer formats 3½", 5¼", 8" DISKS, MAGTAPES, MAGCARDS, CARTRIDGES, CASSETTES

DISK DUPLICATION OCR SCANNING SERVICES

Customized conversions too!
Call us for quality, best prices and quickest turnaround time

COMPANY COMPENDIA, INC.
TEL.: (312) 419-8771 (Chicago)
FAX.: (312) 419-1390

CIRCLE 561 ON READER SERVICE CARD



We transfer files between incompatible computers. Thousands of formats supported among dedicated word processors, DOS, DEC VAX, UNIX, XENIX, Apple and Macintosh.

- Cartridge tapes (incl. TK-50, TK-70)
- 9-track tape (800 to 6250BPI)
- 3.5", 5.25", 8" floppy disks and Syquest

For cost effective, quality conversions, call

Disk Interchange Service Co.
2 Park Drive • Westford, MA 01886
(508) 692-0050

CIRCLE 525 ON READER SERVICE CARD

Data Recovery

ONTRACK DATA RECOVERY

The Data Recovery Professionals

Ontrack Data Recovery specializes in recapturing data from any microcomputer hard drive or floppy diskette.

- 95% Success Rate • Fast Turn Around
- Priority service available • Expertise with Novell, DOS, Macintosh, OS/2, Unix, Xenix, Bernoulli, Sun and more!

Find out why we are the leaders in data recovery - call an Ontrack Data Recovery representative today for more information.

1-800-872-2599

International: 612-937-5161 • FAX: 612-937-5750

CIRCLE 464 ON READER SERVICE CARD

Disk Copy Service

DUPLICATION FROM \$.59 HIGHEST QUALITY MEDIA

MSDOS duplication from \$.59(5.25") and \$.89(3.5"). Prices go even lower as you continue to order!

- Duplication + 100% Verification
- Custom Labels/Sleeves/Mailers
- Custom Packaging & Assembly
- Colored Media Available
- Special Rates For Demo Software & Site Licensing
- Educational Discounts Available
- 24 Hour Turn-Around
- Guaranteed Products

800-255-3142

Diversified Systems Group, Inc.
PO Box 1114, Issaquah WA 98027

CIRCLE 422 ON READER SERVICE CARD

Disks

FORMATTED DISKETTES BASF, VERBATIM, SONY

WITH FORMAT	QTY 250 MIX & MATCH	WITHOUT FORMAT
\$.44	5.25" DS/DD	\$.39
\$.69	5.25" DS/HD	\$.59
\$.65	3.50" DS/DD	\$.56
\$1.19	3.50" DS/HD	\$1.09

- **FREE FORMATTING** on First Order
- **TYVEC SLEEVES** & Labels Included
- **COLORED MEDIA** Please Add \$.05
- **PRIVATE LABELING** Available
- **SAME DAY** Shipping
- **MONEY BACK GUARANTEE**

800-255-3142

Diversified Systems Group, Inc.
PO Box 1114, Issaquah WA 98027

CIRCLE 448 ON READER SERVICE CARD

Duplication Services

Providing the highest quality disk duplication through state-of-the-art equipment, quality media and attention to detail:

- All 3.5" & 5.25" Formats
- 100% Verification
- Label Print & Assembly
- NO Minimums per run
- 24 Hour Turn-Around
- Customized Services

Duplication Services Corporation
Scottsdale, Arizona
(800) 322-8392 or (602) 451-4648

Security

HARDWARE VIRUS-KILLER

Protect accounting and word processing data with U.S.-made PC-Cure™, a new electronic device in an RS-232 line that disables computer viruses. IBM- and Apple-compatible. With power pack and 2 software drivers. **\$279 (+\$4 UPS)**
Seven Mountains Scientific, Inc.
P.O. Box 650
Boalsburg, PA 16827
Phone/fax: **814-466-6559**

CIRCLE 455 ON READER SERVICE CARD

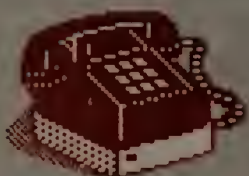

Call Sandie Wade
PC World Catalog Manager
1-800-435-7766
1-800-435-7760 (in CA)

CATALOG

PC WORLD

Shop The PC World Catalog for fast solutions to your PC needs.

Slides

Slides overheads

Over a hundred PC & Mac programs supported. Slides from word processing, graphics and presentation programs. From \$3.00/slide. Fast service.

Elegant Graphic Slide Service

(707) 795-3272

FAX (707) 795-3286

CIRCLE 491 ON READER SERVICE CARD

reconditioned **TONER** cartridges!
for laser printers & Canon PC Copiers

BETTER THAN NEW!

- 20% MORE TONER
- DARKER PRINT
- 100% GUARANTEED

Willow Products Corp.
3857 Willow Ave, Pgh, PA 15234

From **\$44.95**

We buy empties
call for brochure
800-426-8196



CIRCLE 535 ON READER SERVICE CARD

Remanufactured Cartridges **TONER** \$36

For Canon, Hp, Apple
Gms Laser printers & Canon PC Copiers

- 20% MORE TONER
- 100% Guaranteed

ALR Tech, Inc.
5325 SW 77 Ct, #211
Miami, FL-33155

Tel: (305) 271-4953
800-484-1008/5475

Also Sharp & IBM 4019 recharged
Recharge 5 get one
recharge **Free**

CIRCLE 569 ON READER SERVICE CARD

THE GENERAL STORE

Retail Store Management

The complete software system for Retail. Multiuser/Network ready. Supports cash drawers, barcode, receipt printers, customer displays, scales and online credit card authorization. Controls all types of retail stores. Multistore, size-color matrix, parts explosion and serialized items. Field proven in thousands of installations. Turnkey hardware & software systems.

ACCOUNTS RECEIVABLE
INVENTORY CONTROL
POINT OF SALE
ACCOUNTS PAYABLE
GENERAL LEDGER
MAILING LIST
• HARDGOODS
• APPAREL

\$995 Complete system
Dealer inquiries Invited.

CRICLOW DATA SCIENCES
804-523-6600 Fax 523-4668

CIRCLE 470 ON READER SERVICE CARD

Supplies

Computer Business Forms

Software Compatible & Custom Designed Forms for all industries.

- Invoices
 - Statements
 - A/P & P/R Checks & More....!
- Call: Tom MacDonald 800-772-8027 or Mail/Fax a sample for a free quote. Please include number of parts and quantities when faxing.

FAX# 617-246-1564

STANDARD OFFICE SYSTEMS

384 LOWELL STREET

P.O. BOX 4035

WAKEFIELD, MA 01880

U.S. Cartridge Service
NOT A GOVERNMENT AGENCY

TONER CARTRIDGES. REMANUFACTURED

for laser printers and PC Copiers

2 DAY DELIVERY AVAILABLE

92 RANDOLPH AVE.
SO. SAN FRANCISCO, CA 94080

\$29.95

20% MORE TONER
100% GUARANTEED
24hr TURNAROUND
WE BUY EMPTIES!!!

1-800-553-4345

CIRCLE 466 ON READER SERVICE CARD

SOFTWARE/ Accounting

dBASE Business Tools

- General Ledger
- Accounts Payable
- dInvoicer & A/R
- Sales Analysis
- Order Entry
- Purchasing/Invnty
- Payroll
- Lazar-Forms
- Job Costing
- Job Estimating
- Bill of Materials

\$99 ea. incl. Source Code M/C-AMEX-

Visa-Check-COD

Datamar Systems

8586 Miramar Place

San Diego, CA 92121

800/223-9963, 619/452-0044

MIP Fund Accounting

MIP means Fund Accounting. A system designed for not-for-profits.

- * General Ledger
- * Budget Reporting
- * Accounts Payable
- * A/R & Billing
- * Encumbrance/P.O.
- * Interface
- * Payroll
- * Fixed Assets
- * Training & Demo

Call 800-647-3863 for your Fund Accounting needs.

MIP Fund Accounting

505 East Huntland Dr. Suite 340

Austin, TX 78752-3714

800-647-3863, 512-454-5004

ProTime

Track billable time, invoice clients for products and services, account for transactions and more! Perfect for consultants, contractors, attorneys, doctors and others.

\$179

info
DESIGN

(800) 367-0060

CIRCLE 460 ON READER SERVICE CARD

DATASMITH™ Payroll

Use our screen, or your spreadsheet, database, word processor to prepare hours data. IMPORT/EXPORT option reads/writes ASCII files. Easily used with time clock & badge reader systems. One version supports single user or LAN systems. Order demo today!

LPI Information Systems

10020 Fontana

Overland Park, KS 66207

913/381-9118

Toner Cartridges Remanufactured

24 Hour Turnaround
Premium Graphics Black
Long-Life Drums Available
100% Guaranteed

HP, Apple, IBM 4019,
Canon, etc.

36.50

Font Cartridges Memory Boards

Strategic Business Solutions Corp.

800-745-6710

57 New Monmouth Rd.
Middletown, NJ 07748

We'll Keep You In The Black
CIRCLE 547 ON READER SERVICE CARD

FORMS and SUPPLIES

Business Forms

- * Custom and Stock
 - * Dac Easy, Peachtree + hundreds more
 - * Business cards, letterhead,
 - * Envelopes, labels.
 - All types of supplies.
 - * Paper, Ribbons, Toner, Diskettes
 - * Tapes, Rubber Stamps
- Volume Discounts Available.
Reference this ad for a 10% discount.
M&V Computing and Printing
5698 Novack Street
Winston-Salem, NC 27105
1-800-729-5338

CHECK US OUT

AT COUGAR MOUNTAIN SOFTWARE,
WE OFFER ONLY THE BEST IN
ACCOUNTING SOFTWARE.

- Field tested for over 8 years

General Ledger, Accounts Payable, Accounts Receivable,
Payroll, Check Reconciliation, Inventory, Order Entry/Invoicing,
Purchase Order Tracking, Lynx (ASCII File Converter)

SINGLE USERS

\$199.50

+ 15.50 shipping & handling

LAN VERSION

\$999.50

+ 15.50 shipping & handling

COUGAR
MOUNTAIN
S.O.F.T.W.A.R.E.

2609 Kosterline, Box 6989, Boise, ID 83707 208-344-2541

1-800-388-3038

CIRCLE 553 ON READER SERVICE CARD

CATALOG

PC WORLD

Shop The PC World Catalog for fast solutions to your PC needs.

Accounting

\$45 — Complete Accounting Software

PACIOLI 2000™ CONTAINS: IBM & Compatibles
 • Billing, A/R, Inventory, A/P, G/L, Purchasing, Budgeting, Auditing — All Integrated.
 • **FREE** UNLIMITED CUSTOMER SUPPORT.
 • **FREE** 2 HOUR TRAINING VIDEOTAPE.
 • Use as single-user or multi-user system. (network ready)
 "The equal of other high end accounting programs in every way but cost!"
New York Times, July 1, 1990
 VISA/MC Orders only: 800-243-1515 Ext. 800 MI Questions: 214-931-2033
 Or: Check/MO -- Add \$6 shipping to: S Software, 2880 Bergey Road, Dept 800 MI, Hatfield, PA 19440



CIRCLE 435 ON READER SERVICE CARD

Business Applications

Pay less to ship UPS!

Automate UPS shipping, save time and money with the Parcel Shipping Program (PSP). Prints UPS labels and COD tags. Maintains customer list. Calculates UPS charges and UPS Manifests, ensures accurate billing. Supports residential & commrc. rates. UPS Approval & \$ back gtd. \$299. \$5 Demo

East Hampton Industries, Inc.
 81 Newtown Lane, Drawer 5069
 East Hampton, NY 11937
 800-645-1188, 516-324-2224
 FAX 516-324-2248

Do You Ship by UPS®?

If you do, the Aristo Parcel Shipping System (APSS™) is for you! Meets all UPS requirements. Prints COD & regular labels, Pickup Manifest, etc. Saves customer list. Calculates zones & charges. Flexible setup menu to suit your needs. On-line help. Optional scale interface & other carriers. (RPS, Airborne, Fed EX, USPS, LTLs, etc). 60 Day \$ back Gtd. UPS acceptance gtd. Full featured demo disk: \$4 s/h.

Aristo Computers, Inc.
 6700 SW 105th Ave. #307-J
 Beaverton, OR 97005
 800/3ARISTO, 503/626-6333

BizPlanBuilder™

Organize ideas, coordinate plans — convince others to support you. Intuitive, logical business & marketing plan template on diskette for launching a new product, service, or company. 90+ pages of outlines, headlines, written texts, tables... formatted into 33 ASCII text files. Follow tutorials, fill in the blanks, edit into a finished plan. 126-page reference includes info about getting money from banks, SBA, investors. Integrated financials in Lotus 2.01 (convert or modify): detailed Budget, Income Statement, Balance Sheet (w/ 16 ratios), Cashflow, Break-Even Analysis. Dazzle your boss, banker or investors. 37,000+ sold! v 4.0 \$129 +shipping

Leverage Your Time & PC
800/ 346-5426
415/ 941-9191
 MC-Visa*AX 30-Day Guarantee

CIRCLE 564 ON READER SERVICE CARD

girl Friday™ 'The 24hr. Secretary'

- Easily keep customer information
- Print labels, envelopes & Rolodex
- Track time and billing services
- Auto print UPS, FEDEX & Airborne
- Built-in calculator & calendar
- Send promotional / collection letters
- Print and sort mass mailings
- Track freight charges
- Prints checks, invoices & forms
- And much, much more!

r: tracs, inc. **\$39.95**
 P.O. Box 457 Round Rock, TX 78880-0457
 Orders: 1-800-447-8722 Tech: 1-512-255-7392

CIRCLE 570 ON READER SERVICE CARD

PC WORLD

TAKING CARE OF BUSINESS

THE PC WORLD SUBSCRIBER HOTLINE



Do you have a subscription problem that needs attention? Are you moving? Have an address change? Do you need to check your expiration date?

For the fastest service simply call our toll-free subscriber hotline: 1-800-234-3498 between the hours of 6 AM and 8 PM, Mountain Time.

Or if you prefer, write us at:
 PC World Subscription Service
 P.O. Box 55029
 Boulder, CO 80322-5029

PC WORLD

High-end groupware.

At \$395 for up to 20 users,* and \$895 for more, Office-Minder™ offers you the lowest-cost-per-user in the industry.

Yet OfficeMinder offers you more practical office capabilities, E-mail, Bulletin board, Address management, Schedule and Project management, To-Do lists, Person-In/Out board and much more.

OfficeMinder includes On-line help, Mouse support, Alarms, Dialer, mail Binders with folders and MHS compatibility.

Using less than 5k of RAM, one of the smallest groupware TSRs available.

Call 1-800-437-4492 today for a brochure and a FREE demo package. 30-day money back guarantee.

* Limited-time offer
\$395.
 Regular price
\$495

CSI

Century Software Incorporated
 Woodridge Technology Park
 310 N. Wilson Ave
 Hartford, Wisconsin 53027
 414-673-4424 • FAX: 414-673-5112

Low-end price.

CIRCLE 485 ON READER SERVICE CARD

DISK-COUNT SOFTWARE

800-448-6658 908-541-8768
 LOWEST PRICES INCLUDING SHIPPING

HOURS
 M-F 10-7 S 9-1

DISK-COUNT SOFTWARE			800-448-6658 908-541-8768 LOWEST PRICES INCLUDING SHIPPING			HOURS M-F 10-7 S 9-1		
Adobe Type Manager	61	Go Script Plus	169	Pagemaker 4.0	459	Dragons Lair II	37	SOUND CARDS
A.T.M. Plus	125	Grammatik IV	59	Peachtree Bonus	199	E Z Cosmos	42	Ad Lib 95
Alpha Four	289	Harvard Geographics	235	PFS: First Choice	75	Falcon 3.0	42	Ad Lib Microchannel 139
Ami Pro 1.2	285	Harvard Graphics 2.3	275	PFS: First Publisher	75	Heart of China	37	Ad Lib Software (all titles) CALL
Animator	265	Hijaak	99	PFS: Window Works	105	King's Quest V	37	Pro Audio Spectrum 249
Autosketch	135	Just Write	75	Procomm Plus	69	Links	37	Roland LAPC-1 395
Catchword	125	Lotus 1-2-3 v2.3	319	Project for Windows	385	Mickey's ABC or 123	31	Sound Blaster 145
Central Point Antivirus	77	Lotus 1-2-3 v 3.1	370	Publishers Paintbrush	265	PC Globe or USA	37	Sound Blaster Midi Kit 59
Corel Draw 2.0	329	Lotus Works	84	Publishers Powerpak	47	PGA Golf	32	MIDI INTERFACE
dBase IV	449	Microsoft C	285	O & A	225	Print Shop	36	Music Quest PC Midi Card 95
Definitions Plus	49	Microsoft Fortran	250	O E M M	59	Quest for Glory II	37	MQX - 16 145
Desqview 2.3	69	Norton Utilities 5.0	103	Quicken 4.0	36	Sim Earth	41	Roland MPU-IPC 135
Desqview 386	115	Object Vision (intro price)	92	Spinnell	56	Space Quest IV	37	Cakewalk 95
Draw Plus	119	Pascal for Windows	155	Toolbook for Windows	279	Where is Carmen in USA	31	Copyist Apprentice 95
Excel for Windows	295	PC Anywhere IV	95	Ventura Publisher	499	in World (Deluxe)	49	Master Tracks Pro 199
Facelift	59	PC Kwik Powerpak	65	Word for Windows	285	Wing Commander II	49	Musicator 375
Generic Cadd 5.0	269	PC Tools 7.0	109	Word Perfect 5.1	229	1000's of Titles available	49	Music Pnnter Plus 419

Master Card, Visa & American Express accepted. No surcharge on credit cards. No C.O.D.'s. By mail: P.O. Box 3, Carteret, N.J. 07008. All products are new. We do not guarantee compatibility. NO REFUNDS. Exchanges on defective merchandise only. NO EXCEPTIONS. Shipping charges: To the contiguous 48 states \$4. Alaska and Hawaii \$10. 1st pc. \$1 ea. add. APO/FPO boxes \$6. Canada \$8. 1st pc. \$1. ea. add. N.J. residents add 7% sales tax.

CIRCLE 546 ON READER SERVICE CARD

BUY WITH CONFIDENCE!

CATALOG

CATALOG

PC WORLD

Shop The PC World Catalog for fast solutions to your PC needs.

Church Applications

CHURCH SOFTWARE

Discover for yourself why more churches are choosing **Power Church Plus**.
Try out the leading membership and accounting package - **On Sale Now!**
Call today for your **FREE** full-working DEMO.
F1 SOFTWARE, 6300 Variel Avenue, Suite H, Woodland Hills, CA 91367
(800) 486-1800 (818) 888-1800

CIRCLE 562 ON READER SERVICE CARD

Church Mgm't Systems

Easy-to-use, flexible & integrated. Network version available. Local representatives & toll-free support back a comprehensive line of Church & School products. 1200+ satisfied Church, School & Government users. Write or call,
The Software Library
3300 Bass Lake Rd.
Brooklyn Center, MN 55429
800/247-8044, 612/566-4212

Membership Software!

Finally there's an easy way to organize your church & alumni memberships!
* Customize up to 100 fields on one screen!
* Contribution system with bar code available.
* General ledger, accounts payable & budgets.
* Computer systems available.
Authorized IBM business partner.
Why waste time with your old membership methods? Call or write today for more information.
Angel Systems, Inc.
323 N. Wisconsin Avenue
Massapequa, NY 11758
800-237-0375, 516-420-0000

Church Partner

Written by Computer professionals involved in church management. Skilled users love its power, depth and flexibility. Novices love its ease of use. 13 optional modules with support and upgrades. For IBM compatibles, LANs, Macintosh, XENIX. We understand computers and churches. New Release: School Partner, for church-related dayschool and child care.
Summit Systems, Inc.
Suite 121, 16 Berry Hill Rd.
Columbia, SC 29210
803-798-9749, FAX: 803-731-0349

Communications

\$97 Protocol Analyzer

AsyncPro turns PC/AT into a RS232 Async. protocol analyzer without spending thousands of dollars.
• 110 to 19.2K, DTR/RTS controls
• ASCII/HEX display & print formats
• ASCII/Binary capture modes
• 28K Buffer, search/save/retrieve
• PC/AT/386, 256K, COM1/2, DOS 3.x. AsyncPro ver 1.1 \$99

Ai Engineering
47000 Warm Springs Blvd, Suite 158
Fremont, CA 94539
415-770-8598

Database Publishing

Directories In An Instant!

Use **INSTANT DIRECTORY** to create company directories, client lists, white pages & more. With **INSTANT DIRECTORY'S** easy-to-use database and 30 preset reports, you can print your updated directory in an instant. No desktop publishing skills needed. **SAVE \$70 off list, buy now for \$79.**
DIGITAL COMPOSITION SYSTEMS
1-800-527-2506 ext. 6251

CIRCLE 505 ON READER SERVICE CARD

Data Entry

DATA ENTRY

Why have over 85% of the largest companies in the U.S. selected the **RODE/PC Data Entry System?**

The answer will be obvious when you call for information and a free demonstration today.



(415) 323-8195

DPX • 490 California Avenue
Palo Alto, CA 94306

CIRCLE 558 ON READER SERVICE CARD

Construction

COST ESTIMATING

Comprehensive, **stand-alone** cost estimating systems for **general** and **specialty** construction. Easy to use, pull-down menus, **Lookup** windows. All systems include built-in industry-specific **cost database**, on-screen Takeoff Calculator, User's Manual and free unlimited telephone support.

- **PC-Estimator** - General construction. \$99
 - **Remodel Estimator** - Home Improvement. \$89
 - **Electrical Estimator** \$295
 - **Plumbing Estimator** \$295
 - **Painting Estimator** \$295
 - **PC-Adjuster** - Property Claim estimates. \$195
- Demo/Shareware package for any of above. \$25

VISA, MC, Check, MO, COD. S&H \$6.50.
CA residents add sales tax. COD add \$5.00.
CPR, Inc. P.O. Box 3465, Berkeley, CA 94703
(Dealer inquiries welcome)

Call: (415) 654-8338

CIRCLE 444 ON READER SERVICE CARD

Viking Data Entry

Professional Quality Software
• Used by U.S. Census
• Advanced Validation
• Sequential/ISAM files
• MS/DOS, UNIX, XENIX, VMS, AIX
• Technical support
• Re-key verify
Viking Software Services
4808 E. 67th St., Ste. 100
Tulsa, OK 74136
918/491-6144 FAX: 918/494-2701

Educational

BS & MS in Comp Sci

The American Institute for Computer Sciences offers an in-depth correspondence program to earn your Bachelor of Science & Master of Science in Computer Science at home. BS subjects covered are: MS/DOS, BASIC, PASCAL, C, Data File Proc., Data Struct. & Operating systems. MS includes SW Engineering, AI and other topics
American Inst. for Computer Sciences
2101-WO Magnolia Ave. So. Ste 200
Birmingham, AL 35205
800/767-2427, 205/323-6191

Entertainment/ Games

Adult VGA Software

Visualize the full potential of VGA and SVGA.

Hi-res, 256 color images.

- Vol. 1 **Swimsuit** (6 disks per vol.) \$13.95
- Vol. 2 **Au Naturel** \$13.95
- Vol. 3 **Daring** \$13.95
- Vol. 4 **Adults Only** \$13.95

Hi-res VGA animation. Just like the movies!!!

- Vol. 5 **Adult VGA Movies** \$13.95
- Vol. 11 **Hot Italian Movies** \$13.95
- Vol. 12 **Long Length Movies** \$13.95

Special.... Order 4 volumes, select 5th free!

Choose from six 5 1/4" DD disks, three 5 1/4" HD (best deal), three 3 1/2" DD, or two 3 1/2" HD for each vol. All disks are full. Vol. 12 available in only HD disks.

Get more great software for less. Guaranteed. Fast service. Order today. Include \$3 S&H. Must state age 21 or over. Send check or MO to:
Int'l. orders add \$3. US funds only
MC/VISA orders or free Dept. CW, P.O. Box 36
catalog call (309)452-7760. Normal, IL 61761

CIRCLE 496 ON READER SERVICE CARD

THE LOTTO EDGE HI-TECH LOTTO ANALYZER

Quality Computer-Assisted Number Analyzer

You make your analysis and choose your game-play numbers from computer calculated displays and reports. Data is based on your state's winning number history, using hi-tech statistical methods. You update weekly. Min. 256K. Programs, manual, one state's data, \$44.95 + \$4.00 shipping and handling. Each additional state \$10.95. Credit card 800/992-4045, ext 439, (CA) 800/777-8814, ext 439 Check/M.O.

The LOTTO EDGE, ODDS UNLIMITED,
P.O. Box 1223, Addison, IL 60101

PLAY TO WIN
LET YOUR PC DO THE WORK!

CIRCLE 549 ON READER SERVICE CARD

Replace dedicated data input systems
Front-end mainframe applications

KeyEntry III

- LAN or stand-alone environments
- ScreenPainter and MenuManager included
- Batch Control System and Reformat utility
- Spanish, German, and French versions
- Outstanding customer support
- Thousands of users worldwide
- OS/2 version

800-533-6879

FREE DEMO DISK AVAILABLE!



SOUTHERN COMPUTER SYSTEMS, INC.
205 251-2925 ■ FAX 205 322-4851
In Europe: SCS Europe, Ltd. 0753-36550 ■ FAX 0753 36765

CATALOG

PC WORLD

Shop The PC World Catalog for fast solutions to your PC needs.

Entertainment/ Games

Financial

Genealogy



Adult Software

Must State
Age Over 21

Disk #1 — An unbelievable visual encounter — MUST SEE!

Disk #2 — **NEW!** 3 encounter games for friends and lovers guaranteed to shed both clothes and inhibitions.

Disk #3 — An anatomical arcade game with unusual ammunition.

Disk #4 — 2 more incredible visual encounters — impress your friends.

Disk #5 — Create your own fantasies about friends and lovers.

Disk #6 — **NEW!** View, print, or edit ten sizzling pictures including celebrities.

\$7 each, any 3 for \$17, or all 6 for \$32. for IBM & compat. CGA, EGA or VGA graphics req'd.

CONNOISSEUR COLLECTION ALL NEW! In 256 Color VGA!!

Disk #CC1 — ★ YOU BE THE STAR ★
The FIRST CUSTOMIZABLE movie allows you to write the dialog and the title. You can star with the partner of your choice. Incredible scenes display with your dialog. ONLY AVAILABLE FROM US!

Disk #CC2 — THE FIRST SOUND MOVIE!
The first computer movie with SOUND. See the incredible 256 color VGA graphics while hearing the actual dialog. OURS EXCLUSIVELY!

Disk #CC3 — THE BEST MOVIE!
The best computer movie available. Only for the serious collector. 256 stunning VGA colors.

1 Movie \$29, 2 Movies \$49, 3 Movies \$65
All CC Disks Require VGA monitor and hard disk — over 1 MB of action.

eXXcapades — The FIRST adult game with TRUE SOUND and 80 sizzling color VGA scenes!

- Options for gender preference and game intensity • Play with 2-8 close friends • Over 5MB of pure action!
- Fulfill your carnal passions with new experiences • Find out how you and your partner can better relate.

\$79 — Special offer: **\$69** with purchase of any CC1, CC2, CC3 disks above — OURS EXCLUSIVELY!

ADD \$3 S/H • 3.5" OR FOREIGN ORDERS ADD \$2 PER DISK • IN PA ADD TAX.
VISA/MC Orders only 800-243-1515 Ext. 600 BN
24 HRS./7 DAYS • Or check/MO to: SeXXy Software, 2880 Bergey Rd, Dept. 600 BN, Hatfield, PA 19440

CIRCLE 523 ON READER SERVICE CARD

Loan Amortization Software

**A favorite of banks
& atty's worldwide!
Over 5000 sold!**

- ✓ Easy Amortization Schedules
- ✓ Replace Financial Calculators

✓ Change variables instantly

- ✓ Creative Financing
- ✓ Fixed or Adjustable
- ✓ APR to US Reg. Z
- ✓ Bi-weekly & more
- ✓ Prepaid Int.
- ✓ Points & Fees
- ✓ PMI Charges
- ✓ Irregular Pymt's
- ✓ Auto. Extra Pymt's
- ✓ Fixed Principal Pymt's
- ✓ Balloon Pymt.
- ✓ Negative Amortization
- ✓ 360, 365, 360/365 int.
- ✓ Solve for an Unknown
- ✓ Yield & Loan Price
- ✓ Store loan to disk
- ✓ Report titles
- ✓ Report comments
- ✓ Calendar or Fiscal Yr
- ✓ No Spreadsheet requ.
- ✓ Editing of data entered
- ✓ Context help screens
- ✓ 18 Digit Accuracy

Exec-Amort™ \$149.95

*Mini-Amort™ \$79.95

5 user Network Version: \$450.00

Order Today Call 800/858-8448

Fax Orders Call 313/791-3010

Phone (313) 791-0770

Electrosonics,
36380 Garfield, Suite 1
Fraser, MI 48026 USA
Demo Disk \$5 Each, VISA, MC, AMEX, Discover
Ground Ship \$5, Air \$13, COD's add \$3.75
International add \$15 *(Excludes APR, Pts & Fees)

CIRCLE 526 ON READER SERVICE CARD

Control Your Finances!

With Maiden Account Manager II (MAM2) Checkbook accounting software for IBM PCs and compatibles.

Turn your PC into your personal accounting assistant! Features: Running Balances, Versatile Reports, Password Security, On-Line Help, Calculator, Report Editor, Budget Graph, and more. Easy to learn and use. Manage your home or office or both! Only \$49.99 + S&H. Order today! 30-day money-back guarantee.

Maiden Financial Software

P.O. Box 5058 C

Laurel, MD 20726

(301) 763-5828

Flow Charting

Windows Flowcharter \$129

RFFlow 2.0 is a professional drawing tool for flowcharts and org charts. Requires Microsoft Windows 3.0. 100 shapes auto adjust in size. Diagonal lines and curves. Auto line routing and re-routing. Click on a shape to bring up a sub-chart. Move charts to other apps. via the Clipboard. Call for free trial disk.

RFF ELECTRONICS

1053 Banyan Court

Loveland, CO 80538

303/663-5767 FAX: 303/669-4889

Family Roots™

Do it YOUR way! Huge variety & capacity for your family history. Make pedigree charts & descendants charts, group sheets, person sheets, indices, histories, address labels, searches, & much more. Call for FREE information. Satisfaction guaranteed. Any PC or compatible. MC/VISA/AmEx welcome.

QUINSEPT

Box 216

Lexington, MA 02173

800/637-ROOT, 617/641-2930

Graphics

MATH EDITING

MathEdit lets you put

$$Z = \frac{(\bar{X}_1 - \bar{X}_2) - (\mu_1 - \mu_2)}{\sqrt{\frac{\sigma_1^2}{n_1} + \frac{\sigma_2^2}{n_2}}}$$

into WordPerfect, Word, WordStar, & other documents **without learning any codes!**

- A display window lets you see your equation as you type it
- MathEdit is \$199

K-TALK COMMUNICATIONS
30 West First Ave. Ste. 100
Columbus, OH 43201
(614) 294-3535

CIRCLE 447 ON READER SERVICE CARD

3 Free Slides from your PC

COMPUTER SLIDE EXPRESS converts your graphic files into 4000 line full color slides, overheads or printouts. All popular programs supported. 24 hour service by modem or disk. As low as \$6.50. Call or FAX for your FREE valuable (\$27.00) coupon & FREE 48 page catalog.
Visual Horizons
180 Metro Park
Rochester, NY 14623
Phone: 716/424-5300
FAX: 716/424-5313

Windows 3.0 BACKGROUNDS

Easily Convert to
BMP, GIF, IMG,
MAC, PCX, RLE

MEGABYTES
of color images
in every product

Send Check or Money Order to
Starware Publishing Corp.
P.O. Box 4188 - Dept. 13
Deerfield Bch, FL 33442

Include \$3 S&H Add \$3 for 3.5"
Add \$3 for foreign FL add 6%
MUST STATE AGE 21

601 Swimsuits	16 color 14.88	256 color 19.88
602, 603, 604, 605 and 606		
Adult	16 color 14.88	256 color 19.88
105 601 - 603	16 color 37.88	256 color 49.88
106 604 - 606	16 color 37.88	256 color 49.88
107 601 - 606	16 color 72.88	256 color 94.88

CIRCLE 550 ON READER SERVICE CARD

Sports Handicapping

Thoroughbred shareware system \$8.00. Commercial horse racing & greyhound handicapping software \$32.95, \$52.95, \$67.95, \$77.95 each. Up to 17 entries analyzed: class, speed, times, odds, track, post, stretch, & finish. Pro Football software - \$42.95. Handicap races & games in minutes. MC/VISA accepted. Free info.
SOFTWARE EXCHANGE
PO Box 250002-PW
W. Bloomfield, MI 48325
313/626-7208. Orders:
1-800/527-9467

ADULT SOFTWARE

- * VGA-SVGA
 - * Exclusive "Loopscans"
 - * 4 disks \$10 per SET
 - * SETS:
 - * #1A - Unbelievable
 - * #2A - Sensational
 - * #3A - Must See
 - * #4A - Beauties
 - * #5A - Gems
 - * Orders Shipped At Once
- Free Sample Disk (include \$1 shipping & handling)
Must be over 21
LOOP PREMIUM GRAPHICS
P.O. Box 597186
Chicago, IL 60659

CATALOG G

Shop *The PC World Catalog* for fast solutions to your PC needs.



Easy 3D Design

Create scale drawings and 3D renderings quickly and easily. With ROOMER2 you can plan your home, small office or stage set for just \$79. For larger projects ROOMER3 is the package to use. Homes, offices, libraries - nearly any interior space can be designed for just \$395. Get our brochure!

Phone (814) 226-5600 FAX (814) 226-5551
Hufnagel Software, Box 747, Clarion PA 16214

\$79

CIRCLE 477 ON READER SERVICE CARD

Design your own dazzling art

FRACTAL GRAPHICS

Software for PC's \$79

Explore "Chaos" science
.DXF and .PCX file compatible
FREE BROCHURE: 802-888-5275
Cedar Software Box 5140-R1, Morrisville VT 05661

Inventory Control/Management

Mr. QuarterMaster

Providing the IC needs of business, govt. & institution stockrooms since 1983. Features include receipts & issues updating, report generation, issue slip, etc. Price \$140. Manual alone with demo: \$30 deductible toward later purchase. Also available: Sales reporting, PO, Estimating, Retail IC & Multi-whse IC systems.

RJL Systems
106 New Haven Avenue
Milford, CT 06460
203/878-0376

Mailing Programs

Today's PC Mail System

Fast! Accurate! Large volume mailers use PostWare software programs to:

- Standardize/correct addresses
 - Add ZIP, ZIP + 4, Car. Rt.
 - Presort 1/2/3 Class
 - Detect duplicates
 - Generate Postnet bar codes
 - Palletize 2/3 Class
 - Qualify for postal discounts
- CASS-Certified. Reported throughputs over 100,000/hr.

Postalsoft, Inc.
4439 Mormon Coulee Rd.
La Crosse, WI 54601-8231
800/831-6245

Mail Order Made Easy!

"Mail Order Master" Software contains all the routines you need to run your Home Mail Order Business. Easy to use features include Powerful Database, Invoicing, Inventory Control, UPS Manifesting, Daily Sales Report, Product Sales Report, Statements, Credit Card Voucher Printout, Bulk Mail Sort plus lots more. IBM compatible. Priced at \$399.00 Hands-On Demo \$15.00

The Marshall Weiner Corp.
1700 Catalina Ave.
Seal Beach, CA 90740
800/874-4656 USA & Canada

CALL TODAY!

Duane Hampson
East Coast Representative
1-800-435-7766



POINT OF SALE INVENTORY

Inventory Control is...
MONEY IN THE BANK
\$189 - \$489
FREE demo



Maintains Inventory
Writes Invoices
Uses Cash Drawer, Receipt Printer, Barcode Scanners
50 different programs
Receivables & Gen. Ledger

Freeman Software - Garland, Texas
800-426-6598 214-270-0625

CIRCLE 445 ON READER SERVICE CARD

The Mail Order Wizard

Complete management system for a catalog, inbound telemarketing, or mail order company. Order processing, inventory mgt, ad forecasting, sales/banking, list mgt, modem charge approval, EDC, UPS manifest w/scale interface. Single and Multi User Systems. Inbound/Outbound Editor's Choice.

Haven Corporation
802 Madison St., Dept W891
Evanston, IL 60202
800/782-8278, 708/869-3434

FREE CLIP ART 56 OF OUR BEST IMAGES

TRY US!
Get 56 of our best selling images - FREE

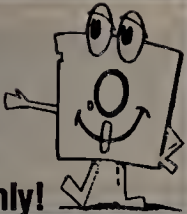

Credit Cards only!

PAY ONLY \$5.00 SHIPPING

SMC
SOFTWARE PUBLISHERS
619 931-8111

CIRCLE 539 ON READER SERVICE CARD

Health

Eat Healthier- Get FIT !!



Top-Rated software has best data available for 2400 foods, 30 nutrients. Plan diets, menus, recipes; shows nutrient excess, deficiency, ratios, graphs.

Used by thousands: USDA, fitness colleges, hospitals, & home-users
Send Now: FREE Demo Disk !!

ESHA
RESEARCH

PO Box 13028-B
Salem, OR 97309
Ph: (503) 585-6242

CIRCLE 573 ON READER SERVICE CARD

Languages

Fortran Compilers

Whether you are developing new code or moving large mainframe programs to the PC, we have the Fortran Language Systems to meet your needs. Winners of PC Magazine's Editor's Choice and Technical Excellence Awards.

LAHEY COMPUTER SYSTEMS
Box 6091
Incline Village, NV 89450
800-548-4778, FAX 702-831-8123

Mail Call[®] Mailing Data Base

Create a valuable data base of your customers, vendors, personnel or other aspects of your organization for quick sorting, editing or printing lists/lables.

\$129

info
DESIGN

(800) 367-0060

CIRCLE 463 ON READER SERVICE CARD

Maintenance Management

Maintenance & Inspection

An integrated maintenance management system, including parts inventory, with clients in Fortune 500 companies, utilities, hospitals, schools, manufacturing & service industries etc. The online system provides operational, planning & analytical reports such as work orders, schedules, skill & inventory requirements, budget reports & reports that summarize history of work performed.

Penguin Computer Consultants
PO Box 20485
San Jose, CA 95160
408/997-7703, Fax: 408/927-0570

CATALOG

PC WORLD

Shop The PC World Catalog for fast solutions to your PC needs.

Medical

Medical Systems with ECS
PPM offers a complt. line of med. SW from simple ins. claims proc. to comprh. A/R mgt.
PC CLAIM PLUS - claims proc. w/ECS to 100+ major ins. carriers - 30 day MB Guar.
THRESHOLD - complete A/R, Pt. Bill, comprh. practice mgt stats.
CLAIM NET - Nationwide elctrnc claims clearinghse transmits to 100+ ins. carriers. SW starts at \$459. Dealer inquiries welcome.
Physicians Practice Management
350 E. New York
Indianapolis, IN 46204
800/428-3515, 317/634-8080

Networking

The \$25 Network

Try the 1st truly low cost LAN

- Connect 2 or 3 PCs, XTs, ATs, PS/2s
- Uses serial ports and null modem cable
- Runs at 115K baud, in only 15k of ram
- Runs in background, totally transparent
- Share any device, any file, any time
- \$25/network, Not Node! Version 2.3m

Skeptical? We make believers!



Information Modes
Drawer F, Denton, TX 76202
817-387-3339 Technical
1-800-628-7992 Orders

CIRCLE 407 ON READER SERVICE CARD



SOFTSHOPPE, INC.

ASP Member

- ✓ Selected Programs
- ✓ Latest Versions
- ✓ As Low as \$1.50

FREE CATALOG
IBM PD/SHAREWARE
POB 3678, Ann Arbor, MI 48106

Call 800-829-BEST (2378)
or 313-761-7638
Fax 313-761-7639

CIRCLE 436 ON READER SERVICE CARD

ELECTRA BYTES "Best of Shareware"

Catalog on disk 2.99 + S&H refunded with first order.
Windows shareware a specialty. (Approx. 600 windows programs available)

Phone 1-800-HOT-BYTES
P.O. Box 801
Brewer, ME 04412

CIRCLE 474 ON READER SERVICE CARD

FREE - 15 DISKS - FREE FULL OF SOFTWARE

TRY US! Get 15/5.25" or 6/3.5" disks of best selling NO VIRUS software for IBM Games•Utilities•Education Business•Publishing-FREE Credit Cards only!

PAY ONLY \$5.00 SHIPPING
SMC SOFTWARE PUBLISHERS
619 931-8111

CIRCLE 544 ON READER SERVICE CARD

Real Estate

Property Management

Rental-Ease. State of the art software. Extremely fast and easy to learn and use. Everything is included: tenant tracking, repairs and maintenance, income and expense, check writing and recurring bills. No extra modules to buy. The ultimate in property management. \$695 complete. Free brochure, Demo \$10.

Strategic Office Systems
688 North 500 West #61
Mt. Pleasant, UT 84647
800/942-6784 or 801/462-2130

• Property Mgt Plus/91 •

New version which looks up tenants & posts rent by Tenant Name. Prints.. Bank Deposit Slips, Rent Statements, & Automatic Checks. Reports. Late Rents, Vacancies & Expired Leases. Posts Management Fees, Pays Owners & does 1099s. Saves up to 80% of accounting time & is the EASIEST system to use! Special pricing from \$575.

Realty Software
133 Paseo de Granada
Redondo Beach, CA 90277
213/372-9419 or 801/649-6149

Property Managers

Easy-to-use software:

- Rental Manager — general purpose accting for apartments, storage units, etc. Built-in gen. ledger.
 - Condo Manager — for community associations. Member payments & charges. Accounting reports.
 - Resort Manager — for units rented on behalf of many owners. Timeshare, reservations, statements.
- Coleman Business Systems*
3654 Arcadian Drive
Castro Valley, CA 94546
415/581-7125

Property Management

Comprehensive software for managing residential, commercial, condos & more. Three versions: Basic PM for owner/manager-\$495, Deluxe PM for professional management-\$1,195, Multi-User with Novell network compatibility-\$2,395. Includes check writing, recurring expenses, G/L, management reporting.

Yardi Systems, Inc.
819 Reddick Street
Santa Barbara, CA 93103
805/966-3666

Property Management

Since 1978 over 7,000 users of our software have found it comprehensive, flexible & easy to use. We offer systems to manage the following types of properties: COMMERCIAL/RESIDENTIAL/CONDOMINIUM/HOME OWNERS ASSOC./MINI-STORAGE FACILITIES. For more information & sample printouts call:

Realty Automation, Inc.
11365 Eastshore Drive
Hayden Lake, ID 83835
208-772-3259

Music

\$19⁹⁵ Test Drive



Don't buy any PC MIDI products before trying the full-line from the industry leader. It's a risk-free way to learn about PC music. Apply the cost if you buy software from us.

Voyetra
Dept. PCD, 333 5th Ave
Pelham, New York 10803
(914) 738-4500 Fax: (914) 738-6946
Orders/Free Catalog: 1-800-233-9377

CIRCLE 476 ON READER SERVICE CARD

Public Domain/ Shareware



Public
(software)
Library

The best organized, most comprehensive, most up-to-date... - PC Today
...Extravagant service...

- Whole Earth Review

Call for a free newsletter:

800-2424-PSL 713-524-6394

Member - ASP

CIRCLE 503 ON READER SERVICE CARD

SongWright V

MUSIC PROCESSOR prints professional sheet music, songs, scores with text, chords, dynamics. Compose, edit, record, play, transcribe, copy, transpose, extract, import, publish - all in standard notation. Symbol editor/librarian. PC, MIDI or SMF entry & playback. Matrix/laser printers. \$99.95 + \$5 s/h. Free sample output.
SONGWRIGHT SOFTWARE
7 Loudoun Street, S.E., Ste. 5B
Leesburg, VA 22075
1-800-877-8070, 703-777-7232

PLACE YOUR AD IN
The PC World
Catalog TODAY.

800-435-7766
In CA: 800-435-7760

Beautiful

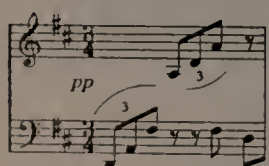

ACTUAL OUTPUT (Reduced)

L.M.P Laser Music Processor

WYSIWYG desktop music scoring on your IBM PC/AT, for the HP-LaserJet/Epson FX/IBM Proprinter printers, VGA/EGA/MCGA/Hercules/CGA/AT&T displays, MIDI transcription, full mouse support and options for PCX files & DeskJet emulation, and much more!

TEACH Services (518)358-2125

182 Donovan Rd, Brushton, New York 12916
BBS (518) 358-3352 (SHIPPING \$5.00 US, NY + 7% TAX)

only \$99.95

CIRCLE 500 ON READER SERVICE CARD

BUY WITH CONFIDENCE!

CATALOG

CATALOG

PC WORLD

Shop The PC World Catalog for fast solutions to your PC needs.

Security



**FIGHT
PIRACY
&
PROTECT
YOUR
PROGRAM
\$\$\$'s!**

Since 1986, companies worldwide have been choosing Az-Tech security products. If you demand the strongest protection available, why not choose one of these "proven leaders":

- EVERLOCK Copy Protection
- EVERLOCK Software Security
- EVERKEY II "The Lock"

For IBM and Compatibles.
30 day money back guarantee.
Free info and demo disk available.



Az-Tech Software, Inc.
201 East Franklin, Ste. 11
Richmond, MO 64085
(800) 227-0644 (816) 776-2700
FAX (816) 776-8398

CIRCLE 593 ON READER SERVICE CARD

Statistics

NEW StatPac Gold IV

Top quality software for survey & marketing research. Covers questionnaire design, sampling, data management, CRT & telephone interviewing, basic analyses & presentation quality graphics. Includes frequencies, tabs, banners, descriptives, t-tests, open-ended response coding, etc.

Free brochure.
StatPac Inc.
3814 Lyndale Ave. S
Minneapolis, MN 55409
(612) 822-8252

StatPlan IV

Only \$199. Easiest to use statistics program available. Statistics include: curve fitting, crosstabs, correlation, multiple regression, stepwise regression, ANOVA, t-tests, time-series analysis, etc. Graphics with printer/plotter output. Handles up to 30,000 data points. Interfaces directly with Lotus and ASCII files. Demo \$10.

The Futures Group
80 Glastonbury Blvd.
Glastonbury, CT 06033
203/633-3501

NCSS 5.x Series - \$125

Easy-to-use menus & spread sheet. Multiple regression. T-tests. ANOVA (up to 10 factors, rep. measures, covariance). Forecasting. Factor, cluster & discriminant analysis. Nonparametrics. Cross Tabulation. Graphics: histograms, box, scatter, etc. Reads ASCII/Lotus. Many new add-on modules.

NCSS
329 North 1000 East
Kaysville, UT 84037
Phone: 801-546-0445
Fax: 801-546-3907

Surveys

The Survey System

A complete, easy-to-learn package for the entry, editing, processing & presentation of questionnaire data. Produces banner format crosstabs & related tables, statistics (incl. regression) & bar charts. Also codes & reports open-ends. All reports are camera-ready. CRT interviewing option available.

Creative Research Systems
15 Lone Oak Ctr., Dept. W
Petaluma, CA 94952
707/765-1001

Utilities

Opt-Tech Sort/Merge 4.0

Extremely fast Sort/Merge program. Run as a DOS command or CALL as a subroutine. Unlimited filesizes, most languages, datatypes & filetypes supported including Btrieve & dBASE. Advanced features include record selection, record reformatting & much more! Call or write for more info. MS-DOS \$149, OS/2, Xenix, Unix \$249.
Opt-Tech Data Processing
PO Box 678
Zephyr Cove, NV 89448
702/588-3737

COPYWRITE

CopyWrite
Removes
Copy Protection.
No more diskettes, manuals or code wheels. \$75. U.S.
1000's of products copied.
Quaid Software Limited
45 Charles St. E. 3rd Fl. Dept. W
Toronto, Ontario M4Y 1S2
416/961-8243, FAX 416/961-6448

PICK THE HARDWARE CATEGORY THAT'S RIGHT FOR YOU

Accessory Boards
Bios Chip
Cables
Computer Rental
CD-Rom
Communications/
Modems
Computer Systems
Connectivity
Disk Drives
Expansion Units
Insurance

Laptops
Memory Boards
Memory Chips
Optical
Peripherals
Plotters
Power Supplies
Printers
Security
Speed Devices
Tandy Peripherals
Tape Back-Ups

Training



Get Back to Basics

The best video training just got better !!

Now \$29.95 reg. \$79.95

Limited time ONLY

UNCONDITIONAL MONEY BACK GUARANTEE

For a complete list of software titles
1-800-759-2737

MV, No C.O.D.'s Software Simplicity
add \$4.50 S&H New Freedom PA 17349

CIRCLE 559 ON READER SERVICE CARD

Ammunition to conquer your biggest problems!

without V-EMM (640 kilobytes)

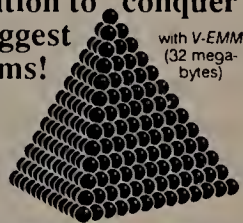

with V-EMM (32 megabytes)

- The Virtual Expanded Memory Manager provides your EMS applications with up to thirty-two megabytes of LIM EMS 4.0 expanded memory
- It turns PC/AT or PS/2 extended memory into expanded memory.
- It turns hard disk storage into expanded memory.
- It's compatible with most EMS applications, including 1-2-3.
- Only \$89.95 30-day money-back guarantee.



V-EMM™

Fort's Software
P. O. Box 1295
Loveland, CO 80539
(303) 663-5629

CIRCLE 551 ON READER SERVICE CARD

PLACE YOUR AD IN The PC World Catalog TODAY.
800-435-7766
In CA: 800-435-7760

DOS 5 Enhancement Kit™

Improved memory management: load high on any PC, convert extended to expanded on a 286, disk space to expanded, 704K low DOS memory, more upper DOS memory on a 386, load TSRs into expanded or extended, sets ease-of-use standard with automatic installation and complete user's guide. 30-day guarantee. \$79
Biologic Corp.
7950 Blue Gray Ci.
Manassas, VA 22110-2829
703-368-2949 (703-361-8251 fax)

In-Depth

QuarkXPress In-Depth, Ready,Set,Go!/DesignStudio In-Depth, and PageMaker In-Depth are distinctive monthly journals for involved users of these versatile programs. Each journal is dedicated totally to a single desktop publishing system. Every monthly 12-page issue is a desktop publishing project in itself — focused on a new showcase application and developed using *your* specific desktop publishing system.

Discover the Secrets. You'll see not only **WHAT** you can do, but **HOW** you can do it. You'll discover tips, tricks, and shortcuts that save hours of time and produce spectacular results with your own projects. And you'll get guidelines for making your designs and layouts more professional and eye-catching.

Application-focused. Here's a sample of the applications and tips you'll find in the *In-Depth* journals:

- Anatomy of Ads
- All about Newsletters
- Brochures that Sell
- Stationery and Supplies
- Executive Reports
- The Best Desk Accessories for DTP

No Risk. If you aren't satisfied, you can get a full refund for all unmailed copies at any time.

Subscribe now. A 12-issue subscription only costs \$69, and just one or two power ideas or applications can deliver a substantial payoff from your investment. *Please take a moment to place your order now.*

Add real excitement to your desktop projects. Subscribe today!

**FOR IMMEDIATE SERVICE, CALL TOLL-FREE
1-800-343-0728 FOR CREDIT CARD ORDERS**

(in NH: 924-0100) FAX 1-603-924-9384

or simply fill out the coupon below and mail it TODAY!

YES! Here's my \$69*. Start my *In-Depth* subscription for:

- QuarkXPress PageMaker — Mac
 RSG/DesignStudio PageMaker — PC

Name _____

Company _____

Address _____

City/State/Zip _____

PAYMENT ENCLOSED: Check/Money Order MasterCard VISA AMEX

Card # _____ Expire Date _____

Signature _____

Create single keystrokes for your most often used commands

Macro Power

At the heart of the Macintosh's user-friendliness is its use of pull-down menus to bring the various features of a particular software package under control of the mouse. While this use of menu items is easy and quickly learned, it is not the fastest way to call up frequently used commands. Some programs allow users to access some commands with keyboard equivalents (such as the standard Command-S to save a document). Once the program becomes familiar, most users begin to tire of having use the commands that have not already used by RSG/DS. It's a good idea to refrain from using the keypad keys so that when you open the Calculator desk accessory while running RSG/DS, you can use the keypad keys for conflicts. If you use the keypad keys in combination with other keys to avoid launching a macro when you operate the Calculator.

Step by Step
To create a macro, first make sure that MacroMaker and Macros are installed in your System folder (they are on the Utilities 2 disk that came with your Mac).

Fine-tune pictures and add special effects

Picture Perfect!

Most DTP programs scale, stretch, rotate, and change a few attributes of graphics. RSG/DS has an entire integrated image processing utility for handling RIFF and TIFF images. The graphics Image Control dialog box (Figure 2) within the Edit menu is something that many people notice, but few ever use seriously. It contains terms and concepts that many people never find a use for. At the least they shy away from modifying graphics for fear of ruining the picture. As you will see, experimenting with the Image Control menu can be rewarding, and anything you do can always be undone. There is a huge number of combinations that can have dramatic effects on the image.

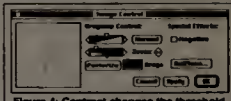
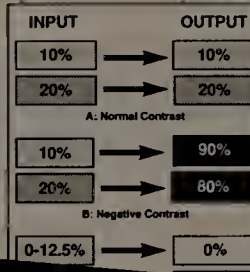

Figure 3: Brightness control darkens or lightens the image.
Figure 4: Contrast changes the threshold between dark and light.
10% gray, the displayed gray value of that pixel (output value) will also be 10%. An important thing to remember is that no matter what image changes you make, you can reset the image to its original Normal values at any time simply by clicking the Normal button.
When the negative checkbox is selected, the output values are...

The journal for involved QuarkXPress users!



Explore three major presentation approaches

Slide by Slide

Presentations come in many shapes and sizes, but all have a common goal: to convince the audience of the merits of your message. This can result in a safe decision, or simply an exchange of information. The first order of business is to decide who your audience is and what they need to see. This article describes three types of presentations: a sales-oriented customer presentation, a high-level executive presentation, and an information-sharing internal presentation. Potential customers want to see why they should buy your product and do business with your company. Using overhead transparencies will make it easy for you to tailor your presentation for a particular customer. Also, because many customer presentations are scheduled at the last minute, overheads give you more flexibility to make these changes. Acetate transparencies are fairly inexpensive and you can print on them directly with a laser printer or copy material on to them with a photocopier. For particularly important presentations, using commercial transparency frames (Figure 1) adds a lot of flexibility for keeping the sheets separate, writing notes on the border of the

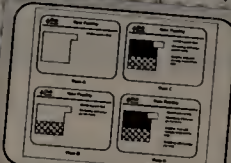

Figure 1: Transparency frame and master template.

ABCs of Charting

The heart of most successful presentations is the graphic charting of complex financial or performance data. Although there are many products designed specifically for version 3.0 has tools that make it easy and quick to whip up custom charts. Even if you import graphic charts from other applications, a mastery of these tools can enhance your presentation of the basic charts. In this article, we will illustrate the step-by-step creation of a useful chart grid that can be used for a variety of chart forms. Then we will build examples of the four most popular types of charts: bar, line, pie, and area charts. Along the way, you'll pick up some handy tips for adding visual impact to charts with depth, shading, rotation, and graduated images. The Basic Grid Virtually every chart (except the pie chart) starts with a basic X-Y grid. The three tools you'll use to create this grid are the Rectangle, Line, and Step-and-Repeat. Before you start drawing, it is worthwhile to digress for a moment, and discuss the selection of measurements. Since you

IN THIS ISSUE

- Slide by Slide 1
- ABCs of Charting 1
- Quick Clicks 1
- Stacking Results 5
- Presentation Construction Kit 6
- Library Card 8
- Get Organized 9
- Reader Forum 12

The *In-Depth* journals are published by MindCraft Publishing Corp. Copyright 1990-1991. All rights reserved.
 *Canadian subscriptions—\$74 (price includes GST). All other foreign orders—\$79. Orders must be prepaid in U.S. funds drawn on a U.S. bank.
 Please make checks payable to **IDG Special Products**.
 Please allow 6 to 8 weeks for delivery.

ADVERTISING SALES

Richard J. Marino
Associate Publisher
Sales, Marketing, & Research

Asst. to the Associate Publisher
Colette Cornish

Eastern Advertising Director
Jeff Edman (201/587-0090)

Western Advertising Director
Sharon Van Leuven (415/243-0500)

Eastern Advertising Manager
Bob Ostrow (508/820-0440)

Mid-Atlantic/Manhattan
John Grogan, Northeast Account
Manager (201/587-0090)

Midwest/Chicago
Mark Taussig, Midwest Account
Manager (708/827-4477)

**Northern California/San
Francisco**
Ellen Levin, Account Manager
(415/243-0500)

Northwest
Greg Mason, Account Manager
(415/243-0500)

**San Diego/Southwest/Orange
County**
Renee Callahan, Account Manager
(714/250-8081)

San Jose
Susan Simmons, Account Manager
(415/243-0500)

Southeast/Atlanta
Judy Sutter, Senior Account
Manager (404/394-0758)

**Southern California/Los
Angeles**
Denise Pilnak, Account Manager
(213/312-8008)

Texas
Harvey Diamond, Account Manager
(214/233-3492)

PC World Catalog
Catalog Advertising Manager
Sandie Wade
Eastern Account Manager
Duane Hampson
Catalog Coordinating Manager
Elizabeth Maffly (800/435-7760 in
California, 800/435-7766 outside
California)

Circulation

Vice President, Circulation
Heather Martin
Asst. to the Vice President
Anna Mercaldi

List Acquisition Manager
Francesca Davies
Circulation Promotion Manager
Ellen DiMatteo
Circulation Business Manager
Noël White
Renewal/Billing Coordinator
Jennifer Paday
Circulation Assistants
David Cobb, Jane Kratochvil
Subscriber Service
Roe Anne Prince

Single Copy Sales Director
George Clark
Single Copy Sales Rep.
Martin Garchar

Marketing & Research

*Director of Marketing
Communications*
Jay McSherry
Marketing Manager
Bruce Frymire
Sales Promotion Director
Nola Armijo
Research Manager
Bill Segovia
Reprints Coordinator Scott Shores
Administrative Assistant
Sandy Wong

Production

Director of Manufacturing
Linda Manes
Production Manager Laura Smith
*Advertising Billing & Booking
Coordinator* Kevin Octavio
Advertising Traffic Coordinator
Paul O'Neil

Administration

Director of Finance Vicki Peilen
Human Resources Director
Richard Willoughby
Asst. to the Publisher
Kelly Milan
Director of Information Services
Walter J. Clegg
Corporate Business Manager
Christina Spence
Accounting/Operations Manager
Pat Murphy
Accounting/Facilities Manager
Michelle Reyes
Financial Analyst
Madeleine Buckingham
Human Resources Administrator
Thalia Ohara
Human Resources Assistant
Maria Chico

ADVERTISER INDEX A TO Z

Get more information—circle the
appropriate number on the read-
er service card.

Reader Service Number	Page Number
3	Acer America Corp. 59
20	Advanced Computer Products. 283
11	Advanced Vision Research 95
—	Aldus. 136-137
45	American Power Conversion. . . 261
306	American Small Business Computers. 239
22	Appian Technology 190
8	Arlington Computer Products. 282
18	Artisoft 14
15	Ashton Tate 26-27
43	ASP Computer Products 36
10	AST Research. 40
14	Austin Computer Systems. . . . 8-9
99	Autodesk 55
32	Berkeley Systems 44
1	Blackship Computer 276
13	Borland International 191
87	Brown-Wagh Publishing. 98
177	Brown-Wagh Publishing 198
215	Buffalo Products. 69
24	Bulldog Computer Products. . . 281
17	Caere Corp. 28
47	Calera Recognition Systems. . . 197
52	Central Point 37-39,126
36	Clarion Software. 234
—	CompuAdd 17-22
58	Computer Associates 25
200	Computer Discount Warehouse. 274-275
48	Corel Systems. 66
53	CTX International. 31
—	Curtis Manufacturing. 7
94	DacEasy, Inc. 45
75	Dell Computer Corp. 119-125
74	Dell Computer Corp. C5-C8
61	Delrina Technology. 201
82	Eikon Systems. 54
—	Epson America, Inc. 4-5
69	Everex. 32-33
100	Fast Micro 268-271
81	Fifth Generation Systems. . . . 109
71	Fifth Generation Systems. . . . 111
235	Fifth Generation Systems. . . . 113
78	First Source International 286

Reader Service Number	Page Number
72	FirstMark Technologies, Ltd. . . 62
76	Fox Software 166-167
60	Funk Software. 240
—	Gateway 2000 89-92
—	Genstar Rental Electronics. . . 232
79	Haventree Software 42
106	hDC Computer Corp. 24
117	Hewlett Packard. 60-61
—	Hewlett Packard 71
—	IBM Corp. 104-105
112	Intel Corp. 233,235
125	JetForm Software 106
41	Kenosha Computer 277
—	L A Trade 278
123	Laser Press & Graphics. 284
128	Liberty Systems 6
—	Lotus Development Corp. . . . 74-77
—	MacFriends 242
168	MicroBiz Corp. 287
—	Micrografx 175,186
177	MicroLogic Software 198
171	Micro Planning International. . 165
167	MicroProse 241
161	Microrim 57
—	Microsoft 35
176	Minuteman Computer. 280
172	MIS Computer Systems. 272
187	NEC Technologies C2-P1
182	NEC Technologies. 43
180	No Rad. 46
186	NRI/Systems Software. 273
197	Okidata 84
209	One Stop Micro 285
—	Pacific Data Products. 48,146
220	Paradise Computer Products . . 279
233	Patton & Patton Software. 34
198	PC Brand, Inc. 220-221
—	PC Connection 140-145
144	Peachtree Software 194-195
244	Precision, Inc. 230
238	Quantum. 179-180
279	Reasonable Solutions. 267
239	Rose Electronics 56
251	Samsung 184-185
31	Secure-It. 62
249	Software Products International 155
—	Software Publishing Corp. 12-13, 51, 204-205
292	Software Workshop. 265
258	SourceMate 260
253	SPSS, Inc. 117
243	STB Systems. 115

PC World is a publication of International Data Group, the world's largest publisher of computer-related information. International Data Group publishes more than 130 computer publications in more than 40 countries. Nineteen million people read one or more International Data Group publications each month. International Data Group's publications include: ARGENTINA's Computerworld Argentina; ASIA's Asian Computerworld; AUSTRALIA's Australian Macworld, Australian PC World, Computerworld Australia; AUSTRIA's Computerwelt Osterreich; BRAZIL's DataNews, PC Mundo; CANADA's ComputerData; CHILE's Computacion Personal, Informatica; COLOMBIA's Computerworld Colombia; DENMARK's CAD/CAM World, Computerworld Danmark, Macworld Danmark, PC World Danmark, Unix World; FINLAND's Mikro PC, Tietoviiikko; FRANCE's Distributique, Info PC, Le Monde Informatique, Télécoms International; HUNGARY's Computerworld SZT, Mikrovilág; INDIA's Computers & Communications; ISRAEL's People & Computers Weekly; ITALY's Computerworld Italia, PC World Italia; JAPAN's ComputerWorld Japan, InfoWorld, Publish; KOREA's Hi-Tech Information/Computerworld; MEXICO's Computerworld Mexico, PC Journal; THE NETHERLANDS' Amiga World, Computerworld Netherlands, PC World Benelux; NEW ZEALAND's Computerworld New Zealand, PC World New Zealand; NIGERIA's PC World Africa; NORWAY's Computerworld Norge, Macworld Norge, PC World Norge; PEOPLE'S REPUBLIC OF CHINA's China Computerworld, China Computerworld Monthly; POLAND's Computers; SPAIN's Amiga World, CIMWorld, Computerworld España, Comunicaciones World, PC World España; SWEDEN's Computer Sweden, Mac World, MikroDatorn, PC/Nyheterna, Svenska PC World; SWITZERLAND's Computerworld Schweiz; TAIWAN's Computerworld Taiwan, PC World Taiwan; UNITED KINGDOM's Graduate Computerworld, ICL Today, Lotus, Macworld, PC Business World; UNITED STATES' AmigaWorld, CIO, Computerworld, Digital NEWS, Federal Computer Week, GamePro, inCider/A+, InfoWorld, International Custom Publishing, Macworld, Network World, PCGames, PC World, Portable Computing, Publish, Run, Sun Tech Journal; USSR's Manager, Network, PC Express, PC World USSR; VENEZUELA's Computerworld Venezuela, Micro Computerworld; WEST GERMANY's Amiga Welt, Computerwoche, Information Management, Macwelt, PC Welt, PC Woche.

AccountMate[®]



**Exploding
the Myth of
"One Size Fits All"
Accounting
Software.**

Do you process Accounts Receivable exactly the way other businesses do? Manage inventory the same way? Generate identical reports?

Of course not. Which is why our accounting software, AccountMate,[®] lets you tailor its functions to fit your business perfectly.

Ready to Use, Ready to Change You may buy one or all of AccountMate's 15 modules—including General Ledger, Accounts Receivable and Payroll—and use them as they are.

In time, however, your business will change and grow. AccountMate lets you add new screens, generate customized reports, or put your "stamp" on an invoice.

With modifiable AccountMate, you'll:

- **Save Money** You don't pay the price of new or wholly customized software as you grow.
- **Save Time** Because you can "block out" features you don't use and add ones you need, you eliminate unnecessary screens and keystrokes.
- **Gain Control** Whenever your business grows, AccountMate can grow with you!

Don't get hemmed in by "one size fits all" accounting software. Join the ranks of 50,000 plus AccountMate users. Call SourceMate for the authorized AccountMate reseller nearest you. Ask about our free Introductory Disk: 1-800-877-8896. International: 415-381-1011. Fax: 415-381-6902.

SourceMate

20 Sunnyside Ave./Mill Valley/CA 94941-1928

*AccountMate is available in MS DOS, LAN, single or multi-user formats.

Reader Service Number	Page Number
279 Symantec.....	10
272 Symantec.....	212
266 Symantec/Norton Utilities... 96-97	
250 Systems Plus.....	181
274 Telescan, Incorporated.....	30
278 Teleware.....	58
264 Texas Instruments.....	53
296 Texas Instruments.....	203
309 313 R/E Ltd.....	63
259 Tiger Software.....	100
285 Toshiba.....	64-65
299 Vitesse, Inc.....	78
325 Western Telematic.....	87
290 Zenith Data Systems.....	156-157
— Zeos International, Ltd.....	80-83
320 ZSoft Corp.....	209

**ADVERTISER INDEX BY
PRODUCT CATEGORY**

Get more information—circle the appropriate number on the reader service card.

Reader Service Number	Page Number
-----------------------	-------------

HARDWARE

Boards/Cards/Chips

22 Appian Technology.....	190
87 Brown-Wagh Publishing.....	98
243 STB Systems.....	115

Computers

3 Acer America Corp.....	59
10 AST Research.....	40
14 Austin Computer Systems.....	8-9
1 Blackship Computer.....	276
— CompuAdd.....	17-22
75 Dell Computer Corp.....	119-125
74 Dell Computer Corp.....	C5-C8
69 Everex.....	32-33
100 Fast Micro.....	268-271
— Gateway 2000.....	89-92
— Genstar Rental Electronics.....	232
— IBM Corp.....	104-105
112 Intel Corp.....	233,235
— MacFriends.....	242
172 MIS Computer Systems.....	272
198 PC Brand, Inc.....	220-221
251 Samsung.....	184-185
264 Texas Instruments.....	53
— Zeos International, Ltd.....	80-83

Connectivity

43 ASP Computer Products.....	36
235 Fifth Generation Systems.....	113
239 Rose Electronics.....	56
325 Western Telematic.....	87

Desktop Publishing

123 Laser Press & Graphics.....	284
— Pacific Data Products.....	48,146

Reader Service Number	Page Number
-----------------------	-------------

Laptop/Notebook

14 Austin Computer Systems.....	8-9
264 Texas Instruments.....	53
285 Toshiba.....	64-65
290 Zenith Data Systems.....	156-157

Local Area Networks

18 Artisoft.....	14
215 Buffalo Products.....	69
235 Fifth Generation Systems.....	113
239 Rose Electronics.....	56
325 Western Telematic.....	87

Monitors

53 CTX International.....	31
187 NEC Technologies.....	C2-P1

Power/Protection

45 American Power Conversion... 261	
-------------------------------------	--

Printers

— Epson America, Inc.....	4-5
117 Hewlett Packard.....	60-61
197 Okidata.....	84
296 Texas Instruments.....	203

Scanners/Digitizers

11 Advanced Vision Research.....	95
----------------------------------	----

Storage Devices

128 Liberty Systems.....	6
182 NEC Technologies.....	43

SOFTWARE

Accounting/Financial

58 Computer Associates.....	25
94 DacEasy, Inc.....	45
144 Peachtree Software.....	194-195
250 Systems Plus.....	181
274 Telescan, Incorporated.....	30
278 Teleware.....	58

CAD/CAM

306 American Small Business Computers.....	239
--	-----

Database Management

15 Ashton Tate.....	26-27
13 Borland International.....	191
36 Clarion Software.....	234
72 FirstMark Technologies, Ltd... 62	
76 Fox Software.....	166-167
161 Microrim.....	57
244 Precision, Inc.....	230
279 Symantec.....	10

Desktop Publishing

61 Delrina Technology.....	201
125 JetForm Software.....	106
320 ZSoft Corp.....	209

Entertainment

167 MicroProse.....	241
---------------------	-----

Fontware

177 Brown-Wagh Publishing.....	198
177 MicroLogic Software.....	198

Graphics

99 Autodesk.....	55
48 Corel Systems.....	66
— Micrografx.....	175,186
320 ZSoft Corp.....	209

Integrated Software

— Hewlett Packard.....	71
------------------------	----

Circle 258 on reader service card

Get a hold of the best value in power protection for just \$199

suggested list price

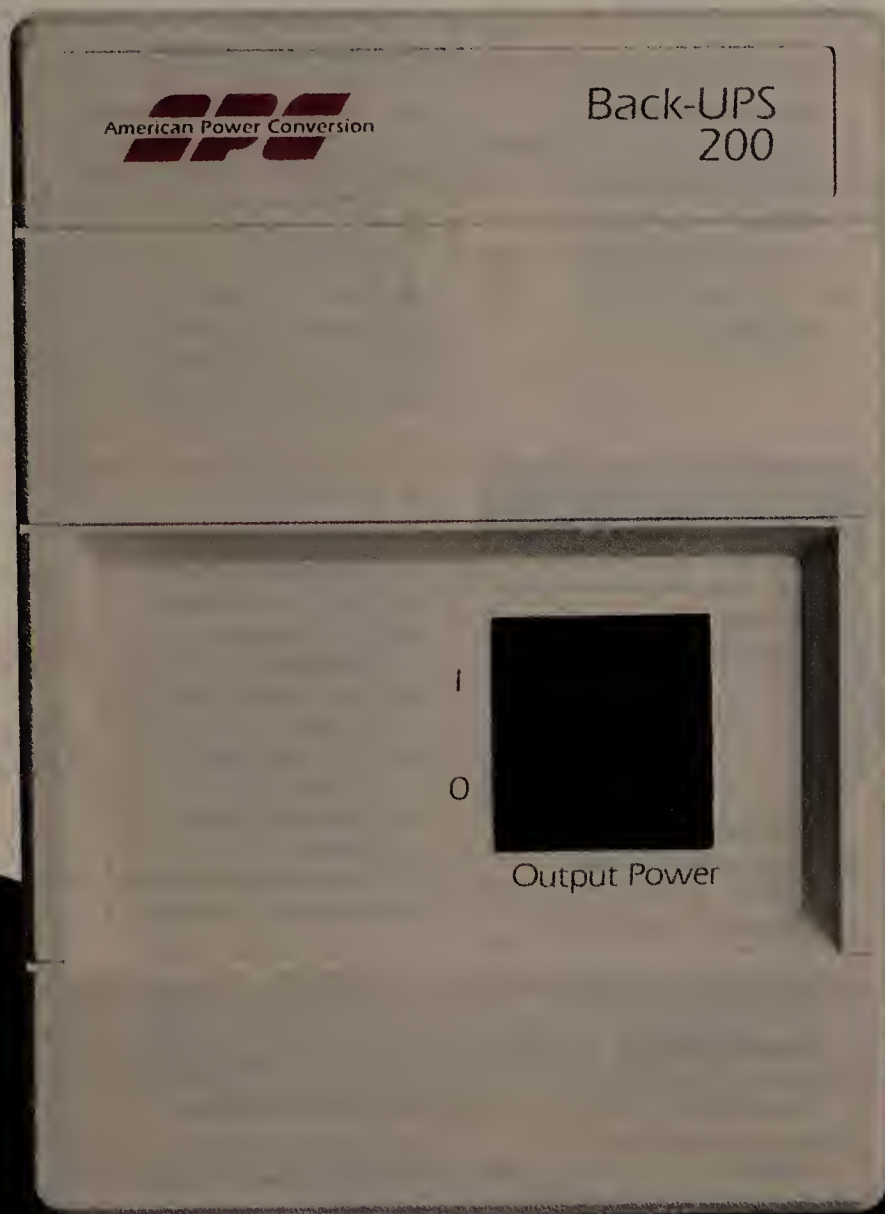

Blackouts, brownouts, sags... Your data and hardware are vulnerable to problems that surge suppressors are just not designed to handle.

Now there's a complete Uninterruptible Power Supply solution. The Back-UPS™ 200 is reliable protection for LAN nodes, 286, 386SX machines, small PS/2 systems, and inter-networking devices such as routers, bridges, gateways and hubs.

From the largest server to the smallest router, the Back-UPS series provides a cost-effective solution. Call for your free power protection handbook.

Circle 45 on reader service card

- Full-time surge protection and line filtering
- Models from 200 to 1200 Volt-Amps, many with LAN interface
- Novell approved with a 2 year warranty
- Rack Mount, Extended Runtime, 220V models available
- Ask about Power-Chute® UPS monitoring software and Novell-compatible UPS monitoring boards



The Back-UPS™
by American Power Conversion
800-541-8896, Dpt. P3
33-1-60078500 in Europe

Reader Service Number	Page Number
249	Software Products International 155
Management	
168	MicroBiz Corp. 287
258	SourceMate 260
Optical Character Recognition	
11	Advanced Vision Research 95
17	Caere Corp. 28
47	Calera Recognition Systems... 197
Other	
32	Berkeley Systems 44
Presentation Graphics	
—	Aldus 136-137
—	Lotus Development Corp. ... 76-77
—	Software Publishing Corp. ... 12-13
Project Management	
79	Haventree Software 42
171	Micro Planning International.. 165
233	Patton & Patton Software..... 34
272	Symantec 212
Protection	
309	313 R/E Ltd. 63
Shareware	
229	Reasonable Solutions..... 267
Spreadsheets/Templates/Forms	
—	Lotus Development Corp. ... 74-75
Statistics	
253	SPSS, Inc. 117
Utilities	
52	Central Point 37-39,126
82	Eikon Systems..... 54
81	Fifth Generation Systems..... 109
71	Fifth Generation Systems..... 111
60	Funk Software..... 240
106	hDC Computer Corp. 24
266	Symantec/Norton Utilities... 96-97
299	Vitesse, Inc. 78
Windows	
48	Corel Systems 66
61	Delrina Technology 201
72	FirstMark Technologies, Ltd... 62
106	hDC Computer Corp. 24
125	JetForm Software 106
—	Micrografx 175,186
144	Peachtree Software 194-195
244	Precision, Inc. 230
292	Software Workshop..... 265
278	Teleware..... 58
299	Vitesse, Inc. 78
Word Processing/Aids	
—	Microsoft 35
—	Software Publishing Corp. 51, 204-205
MISCELLANEOUS	
Computer Accessories	
—	Curtis Manufacturing..... 7
180	No Rad. 46
209	One Stop Micro 285
Mail Order	
20	Advanced Computer Products..... 283

Reader Service Number	Page Number
8	Arlington Computer Products..... 282
24	Bulldog Computer Products... 281
200	Computer Discount Warehouse..... 274-275
78	First Source International 286
—	Gateway 2000 89-92
41	Kenosha Computer 277
—	L A Trade 278
123	Laser Press & Graphics..... 284
168	MicroBiz Corp. 287
176	Minuteman Computer..... 280
220	Paradise Computer Products.. 279
—	PC Connection 140-145
229	Reasonable Solutions..... 267
259	Tiger Software 100
—	Zeos International, Ltd... 80-83
On-Line Services	
238	Quantum..... 179-180
274	Telescan, Incorporated 30
Other	
—	Genstar Rental Electronics... 232
186	NRI/Systems Software..... 273
Security	
31	Secure-It 62

PRODUCTS FEATURED IN EDITORIAL

Get more information—circle the appropriate number on the reader service card.

Reader Service Number	Page Number
Accounting	
629	Accpac Simply Accounting, Computer Associates Int'l 116
638	Expense It 2.0, On the Go Software..... 127
631	SBT Database Accounting Library Professional Series, SBT..... 110
Add-On Board	
748	ATI VGA Wonder XL, ATI Technologies..... 130
749	Boca SuperVGA, Boca Research 130
750	Everex Viewpoint VRAM, Everex Systems 132
751	Genoa SuperVGA 6400A, Genoa Systems 132
607	Mark III, American Megatrends 288
752	Orchid ProDesigner II, Orchid Technology..... 135
753	Paradise VGA 1024, Western Digital 135
754	SigmaVGA Legend, Sigma Designs 135
755	STB PowerGraph Ergo-VGA, STB Systems..... 138
756	Trident Impact III, Trident Microsystems 139
757	Video Seven VRAM II, Headland Technology/Video Seven Products..... 139

Reader Service Number	Page Number
Backup Software	
622	Norton Backup for Windows, Symantec..... 118
CD ROM	
626	NEC CDR-83, NEC Technologies..... 112
627	Tandy CDR-1000, Tandy..... 112
Communications	
640	The Complete Communicator 2.6, The Complete PC 127
Computer System	
710	AcerStation II, 915P(II); Acer 170
707	AT216-6, WLT..... 172
705	Athena 286/16, US Integrated Technologies..... 172
677	Austin 286/16, Austin Computer..... 172
714	BLK286/12, Blackship Computer Systems 170
678	BLK286/16, Blackship Computer Systems 172
676	Bravo 286/16, AST Research 172
697	Data 80, PC House 172
716	Data 286-12, DataWorld 170
620	Datellite 300, MicroSlate 114
717	Dell System 210, Dell Computer..... 170
718	DFI 286/12, DFI 170
681	DFI 286/16, DFI 172
712	D286/12, AEG Olympia..... 170
682	1100S, Eltech Research 172
719	1120S, Eltech Research 170
721	EPS 80286-12, EPS Technologies..... 170
720	Equity 286 Plus, Epson America 170
722	ESC286-12Z, ESC Computers..... 170
694	Executive SL 286/16, Osicom 172
724	FastData 286/12, FastMicro... 170
726	Fortron 286-12, Fortron 170
725	FJ 9200 Series, Flytech Technology..... 170
684	FT 9250 Series, Flytech Technology..... 172
695	GEM 286t, PC America 172
727	HiQ 286/12, HiQuality 170
687	Insight 286, Insight..... 172
729	Leading Spect, Leading Spect 170
689	ME 286/16, Micro Express... 172
691	Mitsuba 286-16, Mitsuba..... 172
692	MMI 286-16 MultiMicro..... 172
730	M-212, Metra Information Systems 170
688	M-216-40, Magitronic Technology..... 172
693	M290S, Olivetti Office USA ... 172
741	Netstation 12V, SuperSet 400II/12V; Twinhead..... 170
675	915V(II), Acer 172
706	PC 250/16, Wang..... 172
731	PC286, NCR 170
704	Plamar 216, Unitek Microsystems 172
734	Poly 286-12Fox, Polywell Computers..... 170

Reader Service Number	Page Number
698	Poly 286-16S, Polywell Computers 172
711	PowerFlex 40, PowerFlex 286; Advanced Logic Research.... 170
732	PowerMate 286/12, NEC Technologies..... 170
679	Preferred 286-16, CSS Laboratories 172
728	ProTurbo 286, Jade Computer..... 170
743	PW 300/12, Unisys 170
690	Smart Micro 286 Plus, Micro Smart..... 172
683	Step 286/16, Tempo 286/16; Everex 172
737	STI 286-12, Sunnytech 170
738	Super 1AT 12MHz, Super Computer..... 170
701	Systek-286/16, Systek 172
736	System 286-12, Sun Moon Star 170
739	TCS-7120, TCS-7450; Tatum 170
723	Tempo 286/12, 286/12c; Everex 170
703	Tenex 286/16, Tenex 172
715	Tomcat 286/12, Boss Technology..... 170
733	Triumph 2000/12-4, The Network Connection..... 170
713	Triumph 286 Plus, Arche Technologies..... 170
735	286 GTX, Proteus Technology 170
740	286e, 286se; TeleVideo..... 170
696	286/16 ISA, PC Brand 172
685	286-16 MHz, Gateway 2000 ... 172
700	286/16, Swan Technologies ... 172
699	286/16, Reply..... 172
702	2500 XL/2, Tandy 172
742	Ultra 286-12, Ultra Comp.... 170
680	Warrior 16/S, C2..... 172
Data Base Management	
639	ACT Network Version, Contact Software Int'l 127
624	dBASE IV Server Edition, Ashton-Tate 114
673	FoxPro 2.0, Fox Software..... 103
625	ZyIndex for Windows, Zylab 118
Data Base Utility	
769	SQL Server Library, Automated Design Systems..... 189
Development Tool	
671	Access SQL 1.20, Software Products Int'l 202
758	Choreographer, GUIDance Technologies..... 189
759	Easel/Workbench, Easel 189
760	Executive Query Tool, Telebit 189
641	Forest & Trees for Windows 1.0, Channel Computing..... 199
674	InfoAlliance for Windows 1.1, Software Publishing 196
762	Nevisys, Nevis Technologies... 189
764	ObjectView, Matesys..... 189
763	Object/1, Micro Data Base Systems 189
765	Omnis 5, Blyth Software..... 189

FREE PRODUCT INFORMATION

PC WORLD

Circle the number corresponding to the product or product category you need to know more about. Manufacturers will rush product information directly to you.

NAME _____

COMPANY _____

ADDRESS _____

CITY _____ STATE _____ ZIP (required) _____

TITLE _____ PHONE () _____

INFORMATION FROM ADVERTISERS

1	2	3	4	5	6	7	8	9	10	11	12	13	14	15	16	17	18	19	20
21	22	23	24	25	26	27	28	29	30	31	32	33	34	35	36	37	38	39	40
41	42	43	44	45	46	47	48	49	50	51	52	53	54	55	56	57	58	59	60
61	62	63	64	65	66	67	68	69	70	71	72	73	74	75	76	77	78	79	80
81	82	83	84	85	86	87	88	89	90	91	92	93	94	95	96	97	98	99	100
101	102	103	104	105	106	107	108	109	110	111	112	113	114	115	116	117	118	119	120
121	122	123	124	125	126	127	128	129	130	131	132	133	134	135	136	137	138	139	140
141	142	143	144	145	146	147	148	149	150	151	152	153	154	155	156	157	158	159	160
161	162	163	164	165	166	167	168	169	170	171	172	173	174	175	176	177	178	179	180
181	182	183	184	185	186	187	188	189	190	191	192	193	194	195	196	197	198	199	200
201	202	203	204	205	206	207	208	209	210	211	212	213	214	215	216	217	218	219	220
221	222	223	224	225	226	227	228	229	230	231	232	233	234	235	236	237	238	239	240
241	242	243	244	245	246	247	248	249	250	251	252	253	254	255	256	257	258	259	260
261	262	263	264	265	266	267	268	269	270	271	272	273	274	275	276	277	278	279	280
281	282	283	284	285	286	287	288	289	290	291	292	293	294	295	296	297	298	299	300
301	302	303	304	305	306	307	308	309	310	311	312	313	314	315	316	317	318	319	320
321	322	323	324	325	326	327	328	329	330	331	332	333	334	335	336	337	338	339	340
341	342	343	344	345	346	347	348	349	350										

CATALOG SECTION

401	402	403	404	405	406	407	408	409	410	411	412	413	414	415	416	417	418	419	420
421	422	423	424	425	426	427	428	429	430	431	432	433	434	435	436	437	438	439	440
441	442	443	444	445	446	447	448	449	450	451	452	453	454	455	456	457	458	459	460
461	462	463	464	465	466	467	468	469	470	471	472	473	474	475	476	477	478	479	480
481	482	483	484	485	486	487	488	489	490	491	492	493	494	495	496	497	498	499	500
501	502	503	504	505	506	507	508	509	510	511	512	513	514	515	516	517	518	519	520
521	522	523	524	525	526	527	528	529	530	531	532	533	534	535	536	537	538	539	540
541	542	543	544	545	546	547	548	549	550	551	552	553	554	555	556	557	558	559	560
561	562	563	564	565	566	567	568	569	570	571	572	573	574	575	576	577	578	579	580
581	582	583	584	585	586	587	588	589	590	591	592	593	594	595	596	597	598	599	600

Check this box for your subscription to *PC WORLD*. You will be billed \$19.97 for a 1-year (12-issue) subscription (U.S. only).

PRODUCTS FEATURED IN EDITORIAL

601	602	603	604	605	606	607	608	609	610	611	612	613	614	615	616	617	618	619	620
621	622	623	624	625	626	627	628	629	630	631	632	633	634	635	636	637	638	639	640
641	642	643	644	645	646	647	648	649	650	651	652	653	654	655	656	657	658	659	660
661	662	663	664	665	666	667	668	669	670	671	672	673	674	675	676	677	678	679	680
681	682	683	684	685	686	687	688	689	690	691	692	693	694	695	696	697	698	699	700
701	702	703	704	705	706	707	708	709	710	711	712	713	714	715	716	717	718	719	720
721	722	723	724	725	726	727	728	729	730	731	732	733	734	735	736	737	738	739	740
741	742	743	744	745	746	747	748	749	750	751	752	753	754	755	756	757	758	759	760
761	762	763	764	765	766	767	768	769	770	771	772	773	774	775	776	777	778	779	780
781	782	783	784	785	786	787	788	789	790	791	792	793	794	795	796	797	798	799	800
801	802	803	804	805	806	807	808	809	810	811	812	813	814	815	816	817	818	819	820
821	822	823	824	825	826	827	828	829	830	831	832	833	834	835	836	837	838	839	840
841	842	843	844	845	846	847	848	849	850	851	852	853	854	855	856	857	858	859	860
861	862	863	864	865	866	867	868	869	870	871	872	873	874	875	876	877	878	879	880
881	882	883	884	885	886	887	888	889	890	891	892	893	894	895	896	897	898	899	900

PRODUCT CATEGORY INFORMATION

For information on an entire category of products or all of the products mentioned in an article, circle the appropriate number below.

Editorial Features (See Article for Number)

901	902	903	904	905	906	907	908	909	910	911	912	913	914	915	916	917	918	919	920
921	922	923	924	925	926	927	928	929	930	931	932	933	934	935	936	937	938	939	940
941	942	943	944	945	946	947	948	949	950										

Advertised Products

Computers	951	Network Products	957
Data Management (PIMs)	952	Operating Environments	958
Desktop Pub./Graphic Software	953	Printers	959
Financial/Accounting	954	Scanners	960
Memory Boards	955	Video Boards	961
Monitors	956	Word Processing	962

August 1991

Expires 12/12/91

Free Product Information



NO POSTAGE
NECESSARY
IF MAILED
IN THE
UNITED STATES

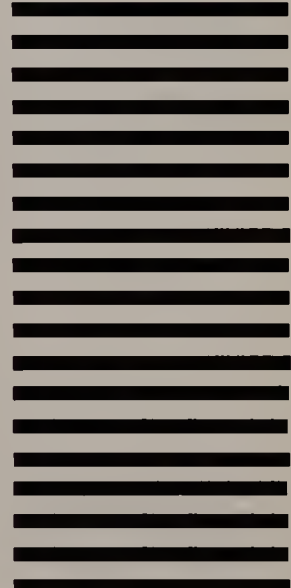

BUSINESS REPLY MAIL
FIRST CLASS PERMIT NO. 758 PITTSFIELD, MA

POSTAGE WILL BE PAID BY ADDRESSEE

PC WORLD

Product Information Center
P.O. Box 5330
Pittsfield, MA 01203-9871



Free Product Information

NO POSTAGE
NECESSARY
IF MAILED
IN THE
UNITED STATES

BUSINESS REPLY MAIL

FIRST CLASS PERMIT NO. 758 PITTSFIELD, MA

POSTAGE WILL BE PAID BY ADDRESSEE

PC WORLD

Product Information Center
P.O. Bdx 5330
Pittsfield, MA 01203-9871



FREE PRODUCT INFORMATION

PC WORLD

NAME _____

COMPANY _____

ADDRESS _____

CITY _____ STATE _____ ZIP (required) _____

TITLE _____ PHONE () _____

Circle the number corresponding to the product or product category you need to know more about. Manufacturers will rush product information directly to you.

INFORMATION FROM ADVERTISERS

1	2	3	4	5	6	7	8	9	10	11	12	13	14	15	16	17	18	19	20
21	22	23	24	25	26	27	28	29	30	31	32	33	34	35	36	37	38	39	40
41	42	43	44	45	46	47	48	49	50	51	52	53	54	55	56	57	58	59	60
61	62	63	64	65	66	67	68	69	70	71	72	73	74	75	76	77	78	79	80
81	82	83	84	85	86	87	88	89	90	91	92	93	94	95	96	97	98	99	100
101	102	103	104	105	106	107	108	109	110	111	112	113	114	115	116	117	118	119	120
121	122	123	124	125	126	127	128	129	130	131	132	133	134	135	136	137	138	139	140
141	142	143	144	145	146	147	148	149	150	151	152	153	154	155	156	157	158	159	160
161	162	163	164	165	166	167	168	169	170	171	172	173	174	175	176	177	178	179	180
181	182	183	184	185	186	187	188	189	190	191	192	193	194	195	196	197	198	199	200
201	202	203	204	205	206	207	208	209	210	211	212	213	214	215	216	217	218	219	220
221	222	223	224	225	226	227	228	229	230	231	232	233	234	235	236	237	238	239	240
241	242	243	244	245	246	247	248	249	250	251	252	253	254	255	256	257	258	259	260
261	262	263	264	265	266	267	268	269	270	271	272	273	274	275	276	277	278	279	280
281	282	283	284	285	286	287	288	289	290	291	292	293	294	295	296	297	298	299	300
301	302	303	304	305	306	307	308	309	310	311	312	313	314	315	316	317	318	319	320
321	322	323	324	325	326	327	328	329	330	331	332	333	334	335	336	337	338	339	340
341	342	343	344	345	346	347	348	349	350										

PRODUCTS FEATURED IN EDITORIAL

601	602	603	604	605	606	607	608	609	610	611	612	613	614	615	616	617	618	619	620
621	622	623	624	625	626	627	628	629	630	631	632	633	634	635	636	637	638	639	640
641	642	643	644	645	646	647	648	649	650	651	652	653	654	655	656	657	658	659	660
661	662	663	664	665	666	667	668	669	670	671	672	673	674	675	676	677	678	679	680
681	682	683	684	685	686	687	688	689	690	691	692	693	694	695	696	697	698	699	700
701	702	703	704	705	706	707	708	709	710	711	712	713	714	715	716	717	718	719	720
721	722	723	724	725	726	727	728	729	730	731	732	733	734	735	736	737	738	739	740
741	742	743	744	745	746	747	748	749	750	751	752	753	754	755	756	757	758	759	760
761	762	763	764	765	766	767	768	769	770	771	772	773	774	775	776	777	778	779	780
781	782	783	784	785	786	787	788	789	790	791	792	793	794	795	796	797	798	799	800
801	802	803	804	805	806	807	808	809	810	811	812	813	814	815	816	817	818	819	820
821	822	823	824	825	826	827	828	829	830	831	832	833	834	835	836	837	838	839	840
841	842	843	844	845	846	847	848	849	850	851	852	853	854	855	856	857	858	859	860
861	862	863	864	865	866	867	868	869	870	871	872	873	874	875	876	877	878	879	880
881	882	883	884	885	886	887	888	889	890	891	892	893	894	895	896	897	898	899	900

PRODUCT CATEGORY INFORMATION

For information on an entire category of products or all of the products mentioned in an article, circle the appropriate number below.

Editorial Features (See Article for Number)

901	902	903	904	905	906	907	908	909	910	911	912	913	914	915	916	917	918	919	920
921	922	923	924	925	926	927	928	929	930	931	932	933	934	935	936	937	938	939	940
941	942	943	944	945	946	947	948	949	950										

Advertised Products

Computers	951	Network Products	957
Data Management (PIMs)	952	Operating Environments	958
Desktop Pub./Graphic Software	953	Printers	959
Financial/Accounting	954	Scanners	960
Memory Boards	955	Video Boards	961
Monitors	956	Word Processing	962

CATALOG SECTION

401	402	403	404	405	406	407	408	409	410	411	412	413	414	415	416	417	418	419	420
421	422	423	424	425	426	427	428	429	430	431	432	433	434	435	436	437	438	439	440
441	442	443	444	445	446	447	448	449	450	451	452	453	454	455	456	457	458	459	460
461	462	463	464	465	466	467	468	469	470	471	472	473	474	475	476	477	478	479	480
481	482	483	484	485	486	487	488	489	490	491	492	493	494	495	496	497	498	499	500
501	502	503	504	505	506	507	508	509	510	511	512	513	514	515	516	517	518	519	520
521	522	523	524	525	526	527	528	529	530	531	532	533	534	535	536	537	538	539	540
541	542	543	544	545	546	547	548	549	550	551	552	553	554	555	556	557	558	559	560
561	562	563	564	565	566	567	568	569	570	571	572	573	574	575	576	577	578	579	580
581	582	583	584	585	586	587	588	589	590	591	592	593	594	595	596	597	598	599	600

Check this box for your subscription to *PC WORLD*. You will be billed \$19.97 for a 1-year (12-issue) subscription (U.S. only).

Reader Service Number	Page Number	Reader Service Number	Page Number	Reader Service Number	Page Number	Reader Service Number	Page Number
766	PC/SQL-Link Windows Requester, Micro Decisionware. 189	744	PFS:WindowWorks, Spinnaker Software 99			651	9034, DataProducts. 160
767	PowerBuilder, Powersoft 189		LAN Application	645	Accel-242, Advanced Matrix Technology. 160	646	NP 80-24E, NP 136-24; AEG Olympia 160
672	Q+E 2.6, Pioneer Software . . . 200	619	MailMan 1.0, Reach Software. 108	647	Allegro 500, Allegro 500XT, ALQ224/GX; Alps America . . . 160	662	NX-2410, NX-2420 Multi-Font; XB-2410, XB-2420 Multi-Font; Star Micronics. 160
768	SQL Commander for Windows, Datura 189	761	Mezzanine, Saros. 189	665	AP1337, Unisys. 160	657	Pinwriter P3200, P6200; NEC Technologies. 160
770	SQL SoftLink, SQLSoft. 189	634	Microsoft Mail 2.1, Microsoft 127	666	BJ-10e, BJ-300, BJ-330; Canon USA 163	655	ProPrinter X24E, PS/1; IBM 160
771	SQLWindows, Gupta Technologies. 189		LAN Operating System	654	B2400, Facit. 160	650	ProWriter C-510, ProWriter C-610+; C-Tech Electronics. . . 160
772	Superbase 4, Precision 189	623	NetWare 2.2, Novell. 108	659	DM124, Olivetti Office USA . . . 160	663	Tandy DMP 240, DMP 302, DMP 2103, DMP 2104; Tandy 160
	Display		Language	669	ExecJet, IBM. 163		Spreadsheet
637	Reduced Emissions Video Graphics Color Monitor; Compaq Computer. 127	621	Visual BASIC, Microsoft. 112	664	ExpressWriter420, Toshiba America Information Systems 160	601	Delta Manager, PC Publishing 218
	Educational		Miscellaneous	649	GSX-140, Citizen America . . . 160	773	1-2-3 for Windows, Lotus Development 85
608	Build Your Own 80486 PC and Save a Bundle, Windcrest Books. . . 288	616	Avery ColorFrames, Avery Commercial Products Division 224	668	HP DeskJet 500, Hewlett-Packard 163		Spreadsheet Utility
	Graphics	617	3M Laser Printer Film, Visual Systems Division. 224	670	JP 350, Olivetti Office USA . . . 163	745	Beyond 640 Intex Solutions. . . . 41
746	Hotshot Imagebase, Symsoft . . . 42	609	Touch Me First, Curtis Manufacturing. 288	667	Kodak Diconix 150 Plus, Eastman Kodak. 163		Storage
	Integrated Software		Modem	660	KX-P1123, KX-P1124i, KX-P1654; Panasonic 160	774	Bernoulli Dual 44, Partner 44; Iomega. 42
610	Eight-in-One 2.03, Spinnaker Software. 148	630	Hayes Pocket Edition 2400, Hayes Microcomputer Products 116	652	LA 70, LA 75; Digital Equipment 160		Utility
611	Enable BP 1.0, Enable Software. 148		On-Line Service	653	LQ-200, LQ-570, LQ-870; Epson America 160	635	Data Junction 4.0, Tools & Techniques. 127
612	Framework XE 1.0, Ashton-Tate 151	604	CompuServe Information Service 227	661	LT-20, SL-90 Plus, SL-230; Seikosha. 160	618	The Norton Utilities 6.0, Symantec. 107
613	Lotus Works 1.0, Lotus Development 152	602	Dow Jones News/Retrieval . . . 227	658	Microline 380, 390 Plus; Okidata. 160	628	Picture Packer Video & Image Compression 110
614	Microsoft Works 2.0, Microsoft 152	605	EBA/net, Electronic Bar Association Legal Info 227	656	MT 82, MT 130/24; Mannesmann Tally 160		Word Processing
615	PFS: First Choice 3.1, Spinnaker Software. 153	603	General Electric Information Service. 227	648	M-1324, M-1824L; Brother Int'l 160	747	Ami Pro 2.0, Lotus Development 93

INTRODUCING



Icon Creator gives you the power you need to create spectacular icons, and take full advantage of Windows 3. Now you can customize Windows by making unique icons for every application, batch file, or document. Start with an existing icon or clip art and just make simple modifications, or start from scratch and create all new icons. Icon Creator is simple to use, yet provides the power you need to unleash your creativity and produce the ultimate icons.

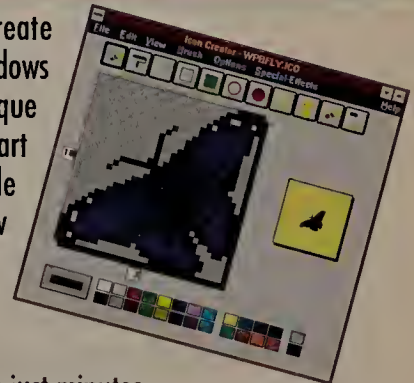

With Icon Creator you'll be creating colorful new icons in just minutes. Get the Power to create icons with Icon Creator.

Icon Creator is another product from Software Workshop - the icon specialists.

FEATURES:

- Complete set of drawing tools
- Sophisticated image manipulation capabilities
- Import and export icons from applications (EXE and DLL files) as well as from icon libraries (ILY and IL files).
- Capture any portion of the Windows screen and use the Paste Manager to create an icon from it.
- Drawing grid and position indicators
- Converts Windows icons to OS/2 format
- Multi-level Undo and Redo
- Context Sensitive Help
- Creates custom cursors.
- Edits Software Workshop's Icon Pak I and II icons.
- Plus many more!

FREE BONUS!
Each package of Icon Creator includes our Cursor Control™ utility Free!



Software Workshop, Inc.
75 South Mountain Way
Orem, UT 84058
801/224-6865
FAX: 801/224-8121

Order Today! 1-800-762-9550
\$49.95 plus 5.00 S/H
Visa M/C Amex accepted
Or visit your Software Etc, CompUSA, or Best Buy store.

Here's Your Chance To Reach The Other 70% Of The Windows Market.



Introducing PC WINDOWS Exposition and Conference, December 9-11, 1991, Moscone Center, San Francisco.

Chances are, you already draw volume buyers of Windows™ products at one of the existing Windows events. But what about the other 70% of the market?

PC WINDOWS is your opportunity to sell to the entire Windows market. All 100% of it.

You asked for it. And now it's here.

In a recent survey conducted by First Market Research of Austin, Texas, 8 of 10 companies said they'd like to see a "public-oriented show" for Windows products. Yet they still expressed a desire to attract big business customers as well.

PC WINDOWS gives you both. December 9 is an invitation-only day exclusively for MIS decision makers, software vendors and developers, resellers, consultants and other VIPs. And December 10 and 11 are open to the general public—small business users, professionals, educators, and home PC users.

Why not show and sell?

While other Windows expos let you show and tell, PC WINDOWS encourages you to show and sell—either directly or in partnership with your resellers. This event is designed to attract buyers, not shoppers.

Take advantage of this opportunity to sell to the other 70% of the Windows market—right at the height of the holiday shopping season. Exhibit at PC WINDOWS, December 9-11, 1991, at San Francisco's Moscone Center. It's the Windows show for everyone.

Need to know more about PC WINDOWS?

Complete this coupon and mail to: Glenn Gaudet, PC WINDOWS, World Expo Corporation, P.O. Box 9107, Framingham, MA 01701-9107. Or fax it to us at 1-508-872-8237. Can't wait? Call Glenn at 1-800-545-EXPO.

- I'd like to know more about *exhibiting* at PC WINDOWS.
- I'd like to know more about *attending* PC WINDOWS.

NAME _____

TITLE _____

ORGANIZATION _____

STREET _____

CITY/TOWN _____ STATE/PROVINCE _____

ZIP/POSTAL CODE _____ COUNTRY _____

TELEPHONE _____ FAX _____

PC WINDOWS is produced by World Expo Corp., producers of MACWORLD Expo and is sponsored by PC WORLD. Both are International Data Group (IDG) companies—the world's leader in information services on information technology. Windows is a trademark of Microsoft Corp.

WT1



PC WINDOWS
EXPOSITION & CONFERENCE

The Windows Show For Everyone

If You Like Our Prices... You'll Love Our Guarantee!

If for Any Reason You're Not Satisfied with Our Product, Return It...Anytime, for a Full Refund!

BUSINESS/HOME

- Amortization Table 3.5 (1115)** - Handles all types.
- Brother's Keeper 4.5C (3 disks) (3120)** - Excellent, full featured genealogy program that's easy to use.
- Express Check 4.04 (2 disks) (1110)** - A great program to manage your checking accounts! Even prints checks!
- FormGen 4.1a/FormFill 1.5 (2 disks) (3240)** - A very versatile form generator and form filler. Create and/or fill out any kind of form for home or business on any printer. Includes numerous sample forms to get you started!
- Home Inventory 4.0 (3137)** - Helps you keep track of everything you own. Great for insurance.
- Home Legal Guide 6.1 (3 disks) (3290)** - Over 150 legal forms for almost everything including wills and living trusts. (HD)
- Mealmaster 6.15S (2 disks) (3160)** - A complete recipe filer. Comes with over 1200 recipes to start you off.
- Names & Dates 4.1 (2 disks) (3140)** - Great personal information manager! Keeps track of anything and everything.
- Painless Accounting 5.0 (3 disks) (1120)** - Complete, easy to use accounting! Includes GL/AR/AP, billing, and more (HD)
- Painless Payroll (2 disks) (1140)** - Does everything from figuring state & federal taxes to writing checks and reports. (HD)
- PC-Write 3.04 (3 disks) (3820)** - Easy to use word processor that is loaded with features including spell checker.
- PrintPartner (2 disks) (3260)** - PrintMaster/PrintShop clone that prints banners, signs and more. Includes 200+ graphics.

CLIP ART (PCX)

Note: These disks contain clip art in PCX (PC-Paintbrush) format. They can be used with WordPerfect 5.0/5.1, Pagemaker, Ventura Publisher, Windows or programs that can read PCX files.

- Accents & Dingbats (2617)
- Alphabet Soup (2 disks) (2890)
- Birds (2 disks) (2620)
- Business (2 disks) (2630)
- Church (4 disks) (2550)
- Education (2 disks) (2640)
- Family (3 disks) (2650)
- Food (2 disks) (2660)
- Complete Clip Art Collection (58 disks) (2990) - 1400+ images!
- Holidays (2616)
- Houses (3 disks) (2680)
- Kids/Cartoons (2 disks) (2820)
- Ladies (2 disks) (2690)
- Medical (2 disks) (1730)
- Misc 1 (4 disks) (2760)
- Sports (2 disks) (2790)
- Wedding (3 disks) (2850)

EDUCATION

- Algebra Tutor (2 disks) (1820)** - Learn Algebra easily! (CGA)
- Lotus Learning System (2 disks) (1420)** - Learn Lotus 2.0 easily and quickly.
- Skyglobe 2.5/Earthwatch 1.2 (2 disks) (1880)** - Look at the stars or the earth. Shows constellations, planets, stars, and more. Fascinating program with great graphics. (CGA)
- Spelling/Vocabulary Tutor (2 disks) (1870)** - Improve your spelling and vocabulary!
- Typing Teacher (1425)** - Learn to type, or improve your typing speed with this set of programs.
- Tutor DOS 1.2 (4 disks) (1450)** - The ultimate DOS tutorial, everything you wanted to know about DOS and more. (HD)
- Verbal Vanquish (1848)** - SAT Verbal preparation!

Shareware programs require separate payment to the authors if found useful.

GAMES

- CGA Tetris Collection (1895)** - Five great variations of the popular game. (CGA)
- Ed's Chess/PowerChess/Chess Tutor (2425)** - Two very good games and a superb tutorial. (CGA)
- Kids' Games (2317)** - Fun for the under 12 set.
- Super Solitaire (2 disks) (2460)** - 15 great versions. (CGA)

EGA/VGA GAMES

- Note: These games require EGA or VGA graphics.
- EGA/VGA Tetris Collection (3 disks) (1920)** - 8 high res variations including 3-dimensional versions!
 - Commander Keen (1926)** - One of the most spectacular games available! Superb sound, graphics!
 - Captain Comic 4 (1925)** - Great sound, graphics & more!
 - Dark Ages (1928)** - From the creators of Commander Keen!

MISCELLANEOUS

- Automenu 4.7 (3515)** - Latest version of the most popular menuing program of all time!
- Best DOS Utilities (3 disks) (3520)** - Essential utilities for DOS. File finders, and numerous other handy utilities that will save you time. Very easy to use.
- Online Bible 5.0 (14 disks) (3170)** - Complete KJV Bible. Includes Greek/Hebrew Lexicon and Cross Reference. (HD)
- PC-Key-Draw 3.75 (4 disks) (2780)** - An exceptionally powerful graphics program. Comes with a large collection of ready made graphics. (CGA) (HD)
- Vaccines and Virus Killers Ver. 77 (2 disks) (3510)** - Protect your system from viruses! This set will find (and destroy!) over 200 viruses and 500+ virus strains.

WORDPERFECT 5.0/5.1

- WordPerfect Art/Graphics 1 (2 disks) (3710)** - Over 90 graphics for WordPerfect 5.0/5.1 & WP for Windows.
- WordPerfect Art/Graphics 2 (2 disks) (3770)** - Over 90 graphics for WordPerfect 5.0/5.1 & WP for Windows.
- WordPerfect Art/Graphics 3 (2 disks) (3780)** - Over 90 graphics for WordPerfect 5.0/5.1 & WP for Windows.
- WordPerfect Art/Graphics 4 (2 disks) (3790)** - Over 90 graphics for WordPerfect 5.0/5.1 & WP for Windows.
- WordPerfect Art/Graphics 5 (2 disks) (3910)** - Over 90 graphics for WordPerfect 5.0/5.1 & WP for Windows.
- WordPerfect 5.0/5.1 Tools (2 disks) (3750)** - 17+ great utilities for WordPerfect 5.0/5.1.
- WordPerfect 5.1 Learning System (3 disks) (4230)** - Learn how to use WordPerfect 5.1 easily and quickly with this great tutorial (WordPerfect 5.1 is NOT required.)
- WordPerfect 5.1 Macros (2 disks) (4220)** - Over 100 helpful macros for WordPerfect 5.1.
- PC-Draft II & III (2 disks) (3760)** - Create clip art & graphics for WordPerfect 5.0/5.1/Windows. (CGA) (HD)

FREE catalog of over 300 programs with every order or by request.

WINDOWS 3.0

- Note: These disks require Windows 3.0
- Active Life/Organize (4536)** - Two "Personal Information Managers" that will keep track of important information.
 - Almanac (4535)** - The ultimate calendar for Windows!
 - ATM Fonts for Windows Vol. 1 (4 disks) (4710)** - 25+ fonts for Adobe Type Manager. Will work with all Windows applications. (Requires Adobe Type Manager.)
 - ATM Fonts for Windows Vol. 2 (4 disks) (4720)** - 25+ additional fonts for Adobe Type Manager.
 - Checkbook Managers for Windows (4559)** - Two wonderful programs to help you manage your checkbook.
 - Chess for Windows (4639)** - Play the great game of chess.
 - The Complete Icon Collection (4 disks) (4580)** - Over 3000 of the best icons available!
 - Cursor Utilities (4885)** - Change the cursor and hourglass into any shape you choose!
 - Fractals & Mandelbrots for Windows (2 disks) (4680)** - Fascinating visual effects and startling graphics.
 - Games for Windows 1 (4591)** - Great games including Klotz (Tetris Clone), Worm War (Centipede Clone), Atmoids, Lunar Lander, Checkers, Backgammon and more!
 - Games for Windows 2 (4592)** - Space Walls, Hextris, Mines, Tic Tac Toe, and more.
 - Games for Windows 3 (4593)** - Tetris, Concentration, Taipei, Arachnid (solitaire variation), Alien Force, and more.
 - Grab Plus 6.0 for Windows (2 disks) (4570)** - Address and print out envelopes from within any Windows application.
 - Hyperdisk 4.2 (4539)** - Make Windows run 2 to 10 times faster! (Will also help other programs run faster.)
 - Icon Utilities (2 disks) (4590)** - A complete set of utilities to create, view and manage icons.
 - Metz Utilities (2 disks) (4690)** - The utilities that received an Editor's Choice from PC Magazine!
 - PC Project 3.0 for Windows (4625)** - A very nice project manager for Windows.
 - Quotes for Windows (4596)** - 3 great programs that will give you quotes for the day.
 - Screen Savers for Windows (4615)** - Eight different screen savers for Windows.
 - Toolbook Programs Vol. 1 (2 disks) (4540)** - Applications and utilities for the Windows Toolbook.
 - Toolbook Programs Vol. 2 (2 disks) (4670)** - More applications & utilities for the Windows Toolbook.
 - Toolbook Games (4675)** - Games for the Toolbook.
 - Toolbook Tutor (2 disks) (4610)** - Learn how to use the Windows Toolbook.
 - Utilities for Windows (4 disks) (4510)** - 50+ utilities that will help you get the most out of Windows, as well as making Windows easier to use. A must for any Windows user!
 - Windows Wallpaper 1 (4 disks) (4520)** - 75+ backgrounds.
 - Windows Wallpaper 2 (4 disks) (4620)** - 75+ backgrounds.
 - Windows Wallpaper 3 (4 disks) (4630)** - 75+ backgrounds.
 - Windows Wallpaper 4 (4 disks) (4640)** - 75+ backgrounds.
- (CGA) Color Graphic Adapter (EGA) EGA Graphics (HD) Hard Disk

Order Toll Free: 800-876-3475

1.75
10 disks or more

2.25
1-9 disks

Information: 503-776-5777/Fax: 503-773-7803

Name _____	Disk size: <input type="checkbox"/> 5¼" <input type="checkbox"/> 3½" (add \$1 per disk if you require 3½")
Business/Company (if applicable) _____	No. Disks _____ x\$ _____ = \$ _____
Address _____	<input type="checkbox"/> Shipping \$ 4.00
City/State/Zip _____	<input type="checkbox"/> Federal Express, Overnight (add \$7) \$ _____
Phone _____	<input type="checkbox"/> Federal Express, 2nd Day (add \$5) \$ _____
All checks must be payable in US funds. We cannot accept Eurocheques.	<input type="checkbox"/> COD (add \$5) \$ _____
Method of Payment: <input type="checkbox"/> Check/Money Order <input type="checkbox"/> Visa/MasterCard <input type="checkbox"/> COD	<input type="checkbox"/> Canada (add \$2) \$ _____
	<input type="checkbox"/> Foreign outside U.S./Canada (add \$4) \$ _____
	TOTAL ORDER: \$ _____

Card No. _____ Exp. Date _____ Signature _____



Reasonable Solutions

2101 West Main, Medford, Oregon 97501
Toll free 800-876-3475, or 503-776-5777, Fax 503-773-7803



Circle 229 on reader service card

PCW 8/91

FastData 386 Systems



FastData 386/33 \$1999

The fastest 386 processor available combined with a 64K thirty nanosecond memory cache make the FastData 386/33 a power users dream! Included in the base price is a 80 megabyte 20 millisecond hard disk, 1024 by 768 VGA monitor and card, four megabytes of memory, and 5.25" & 3.5" high capacity floppy drives. Plus, should anything ever go wrong with your FastData computer, you are covered by a one-year warranty with free on-site service or system replacement if we cannot correct the problem with our FastSHIP advance parts replacement program.

Standard Features

- ✓ 33mhz Intel 386-DX processor.
- ✓ 64K high-speed memory cache.
- ✓ 4 megabytes high speed RAM.
- ✓ 80 mb 20ms IDE hard disk, 1:1 interleave.
- ✓ 1.2mb 5.25" and 1.44mb 3.5" floppy drives.
- ✓ Full size (shown) or standard size chassis with keylock and reset buttons.
- ✓ 387-DX coprocessor socket.
- ✓ 230 watt power supply.
- ✓ 14" Super VGA color monitor, 1024x768 resolution, with 16 bit VGA card with 1mb Video Ram.
- ✓ Clock calendar, parallel port, game port and two serial ports.
- ✓ Keytronics 101 key keyboard.
- ✓ 8 expansion & 5 drive bays.
- ✓ Full Shadow RAM and LIM 4.0 EMS support.
- ✓ DOS 4.01 or 5.0.
- ✓ Windows & Mouse add \$79.
- ✓ FCC Class B approved.

386/33	80mb	100mb	200mb	660mb
Mono	\$1,699	\$1,789	\$2,049	\$3,469
VGA White	\$1,799	\$1,889	\$2,149	\$3,569
VGA Color	\$1,949	\$2,039	\$2,299	\$3,719
VGA 1024	\$1,999	\$2,089	\$2,349	\$3,769



FastData 386/25 \$1799

The optimum combination of features, expandability, and power make the FastData 386/25 an ideal choice for those whose applications demand high speed 32 bit processing and expandability. The value of the 386/25 goes far beyond its price; it comes configured with a full four megabytes of fast RAM, a quick 20 millisecond 80 megabyte hard disk, and maximum VGA displaying 1024 by 768 resolution powered by a high-output 16 bit 1mb VGA board. Also, the FastMicro team will configure your FastData 386 exactly the way you want, without sending you shopping elsewhere.

Standard Features

- ✓ 25mhz Intel 80386-DX.
- ✓ 4 megabytes of high speed RAM.
- ✓ 80 mb 20ms IDE hard disk, 1:1 interleave.
- ✓ 1.2mb 5.25" and 1.44mb 3.5" floppy drives.
- ✓ Standard chassis or mini-tower (shown) with keylock, speed and reset buttons.
- ✓ 80387-DX coprocessor socket.
- ✓ 200 watt power supply.
- ✓ 14" Super VGA color monitor, 1024x768 resolution, with 16 bit VGA card with 512K.
- ✓ Clock calendar, parallel port, two serial ports, and game port.
- ✓ Keytronics 101 key keyboard.
- ✓ 8 slots & 5 drive bays.
- ✓ Full Shadow RAM and LIM 4.0 EMS support.
- ✓ DOS 4.01 or 5.0.
- ✓ Windows & Mouse add \$79.
- ✓ FCC Class B approved.

386/25	40mb	80mb	100mb	200mb
Mono	\$1,369	\$1,499	\$1,589	\$1,849
VGA White	\$1,469	\$1,599	\$1,689	\$1,949
VGA Color	\$1,619	\$1,749	\$1,839	\$2,099
VGA 1024	\$1,669	\$1,799	\$1,889	\$2,149

FastData 486/25

Call about our hot 486, now just \$2,599 with 4mb RAM, Super VGA & 100mb drive. Includes a 128K two-stage cache and is expandable to 64mb of memory.



All FastData Systems Include:

- 30 day money-back guarantee
- Toll-free technical support for life
- One year warranty with on-site service available to most U.S. locations

FastData SX Systems



\$1599 FastData SX/20

25% faster than a 16mhz SX, the FastData SX/20 adds even greater performance to its 386 multitasking capabilities. Just \$200 more than our SX/16, this machine also includes an 80mb hard drive in addition to the super VGA color monitor and 16 bit VGA adaptor, Keytronics keyboard, DOS 4.01 or 5.0, and two floppy drives. The system includes two megabytes of memory and is expandable to eight on the main system board. Remember, when you have questions, need to solve a problem, or want recommendations on products for your system, the FastMicro team is standing by toll-free to provide product support for as long as you own your FastData personal computer.

Standard Features

- ✓ 20mhz Intel 80386-SX processor.
- ✓ 2 megabytes of high speed RAM.
- ✓ 80 mb 20ms IDE hard disk, 1:1 interleave.
- ✓ 1.2mb 5.25" and 1.44mb 3.5" floppy drives.
- ✓ Standard chassis (shown) with keylock, speed and reset buttons.
- ✓ 200 watt power supply
- ✓ 14" Super VGA color monitor with 16 bit VGA card with 512K.
- ✓ Clock calendar, parallel port, two serial ports, and game port.
- ✓ Keytronics 101 key keyboard.
- ✓ 8 expansion slots, 5 drive bays.
- ✓ 80387-SX coprocessor socket.
- ✓ Full Shadow RAM and LIM 4.0 EMS support.
- ✓ Windows & Mouse add \$99.
- ✓ MS-DOS 4.01 or 5.0.
- ✓ FCC Class B approved.

SX/20	40mb	80mb	100mb	200mb
Mono	\$1,169	\$1,299	\$1,389	\$1,649
VGA White	\$1,269	\$1,399	\$1,489	\$1,749
VGA Color	\$1,419	\$1,549	\$1,639	\$1,899
VGA 1024	\$1,469	\$1,599	\$1,689	\$1,949



\$1399 FastData 386/SX

Combine the benefits of an advanced Intel 386 processor, the value of a 286 and the advantages of FastData and you've got the FastData 386/SX! This machine is the choice of those who want to run today's powerful 386 and multitasking software, like Windows, and also want to run their favorite DOS applications at surprising speeds. We've made our customers' favorite options standard: it comes with an ample two megabytes of memory, a high performance 40mb hard drive, and 16 bit super VGA. Compare performance, features, and service and you will find no better SX value. Interested further? Try the FastData 386/SX for 30 days; you have to be happy - if not, we'll take it back.

Standard Features

- ✓ 16mhz Intel 80386-SX processor.
- ✓ 2 megabytes of high speed RAM.
- ✓ 40 mb 28ms IDE hard disk, 1:1 interleave.
- ✓ 1.2mb 5.25" and 1.44mb 3.5" floppy drives.
- ✓ Standard chassis with keylock, speed and reset buttons (mini desktop shown - add \$50).
- ✓ 200 watt power supply
- ✓ 14" Super VGA color monitor with 16 bit VGA card with 512K.
- ✓ Clock calendar, parallel port, two serial ports, and a game port.
- ✓ Keytronics 101 key keyboard.
- ✓ 8 expansion slots, 5 drive bays.
- ✓ 80387-SX coprocessor socket.
- ✓ Full Shadow RAM and LIM 4.0 EMS support.
- ✓ Windows & Mouse add \$99.
- ✓ MS-DOS 4.01 or 5.0.
- ✓ FCC Class B approved.

386/SX	40mb	80mb	100mb	200mb
Mono	\$1,099	\$1,229	\$1,319	\$1,579
VGA White	\$1,199	\$1,329	\$1,419	\$1,679
VGA Color	\$1,349	\$1,479	\$1,569	\$1,829
VGA 1024	\$1,399	\$1,529	\$1,619	\$1,879

FAST MICRO

For information or to order call:
1-800-441-FAST



A Complete 486TM-33 MHz EISA System For Under \$3,000.

You are already familiar with MIS's great price on our fantastic 80386-33MHz system so, now, MIS remains on the forefront of leading edge technology with its 80486-33MHz EISA computer system!

And it's not just another 486TM! MIS incorporates the Micronics motherboard with high quality components to offer the maximum PC at an affordable price. The MIS 486TM-33 EISA supports 80486 CPU burst mode and EISA burst mode for maximum CPU performance and has up to 256K Cache buffer to satisfy DMA requirements on EISA architecture. It also supports up to 64MB of main memory on the motherboard.

MIS 486TM - 33MHz EISA STANDARD

- 1MB 80NS SIMM
- INTEL[®] EISA CHIPSET / PHOENIX[®] EISA BIOS
- 64K EXTERNAL SRAM CACHE
- WEITEK[®] MATH CO-PROCESSOR SOCKET
- TEAC[®] 5.25" 1.2MB FLOPPY DRIVE
- TEAC[®] 3.5" 1.44MB FLOPPY DRIVE
- 43MB AT HARD DISK DRIVE
- 2 SERIAL, 1 PARALLEL AND 1 GAME PORTS
- MGP ADAPTER
- SAMSUNG[®] 12" AMBER MONITOR
- MICROSOFT[®] COMPATIBLE SERIAL MOUSE
- NMB[®] 101-KEY ENHANCED KEYBOARD
- DESKTOP CASE WITH FIVE DRIVE BAYS
- 220W POWER SUPPLY
- ONE YEAR PARTS AND LABOR WARRANTY
- 30-DAY MONEY BACK GUARANTEE

\$2,995

Performing with 32 bit I/O power, the MIS 486TM-33 EISA computer gives you RISC performance with ASIC architecture at a fraction of the cost. It is the ideal platform for UNIX/Xenix as well as high performance CAD/CAM applications.

486-25MHz EISA STANDARD System	\$3,595
486-33MHz ISA STANDARD System	\$2,995
486-25MHz ISA STANDARD System	\$2,595
386-33 MHz STANDARD System w/ 32K Cache	\$1,995
386-25MHz STANDARD System w/ 32K Cache	\$1,845
386-25MHz STANDARD System (Non-Cache)	\$1,595
386SX-20MHz STANDARD System (Non-Cache)	\$1,195
386SX-16MHz STANDARD System (Non-Cache)	\$1,145
286-12MHz STANDARD System	\$ 895

VGA (640x480) Upgrade	Add	\$ 360
P-VGA (1024x768) Upgrade	Add	\$ 450
80MB/105MB/212MB AT Hard Drive Upgrade	Add	\$245/329/745
158MB/380MB/676MB ESDI Hard Drive Upgrade	Add	\$745/1295/1895
RAM Upgrade	Add	\$ 80/MB
64K Cache Upgrade (386-25/33 MHz)	Add	\$ 50
Vertical Case	Add	\$ 125
Mini Vertical Case	Add	\$ 50
CALL FOR ADDITIONAL UPGRADE OPTIONS		

MIS Computer Systems

P.O. Box 70897 Sunnyvale, CA 94086-0897

Order Now

1-800-733-9188

Office Hours: M-F 9:00 am-6:00 pm Pacific Time



Prices and terms are subject to change without notice. 30 days money back does not include shipping charge. CA residents add appropriate sales tax. No surcharge on credit card purchases. Personal and company checks require 2 wks clearance. All names mentioned are registered trademarks of their respective companies.

Circle 172 on reader service card

RUSH POSTAGE-PAID

CHECK ONE

Please send my free catalog on NRI training in:

CARD FOR YOUR FREE CATALOG!

Every NRI course features practical, hands-on training with state-of-the-art equipment you keep. Only NRI gives you the training *and* the equipment for career advancement, part-time earnings, or even a business of your own.

- Computer Programming
- Microcomputer Servicing
- PC Systems Analysis
- PC Software Engineering Using C
- Desktop Publishing & Design
- Word Processing Home Business
- TV/Video/Audio Servicing
- Telecommunications
- Industrial Electronics & Robotics
- Digital Electronics Servicing
- Electronic Circuit Design
- Radio Communications
- Electronic Music Technology
- Basic Electronics
- Building Construction & Remodeling
- Air Conditioning, Heating, & Refrigeration
- Electrician
- Automotive Servicing
- Paralegal
- Fiction/Nonfiction Writing
- Bookkeeping and Accounting

Name *(Please Print)* Age

Street *(No P.O. Box numbers please)*

City State Zip

Accredited Member National Home Study Council

For career courses approved under G.I. Bill, check for details.

4543-081





NO POSTAGE
NECESSARY
IF MAILED
IN THE
UNITED STATES

BUSINESS REPLY MAIL
FIRST CLASS MAIL PERMIT NO. 10008 WASHINGTON, D.C.

POSTAGE WILL BE PAID BY ADDRESSEE

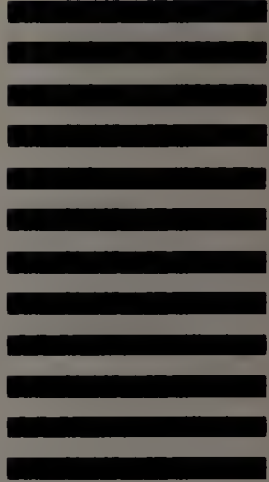

***NRI* SCHOOLS**

McGraw-Hill Continuing Education Center
4401 Connecticut Avenue, NW
Washington, DC 20078-3543



Now with NRI's new training you can enjoy the rewards of a career in computer programming

A top-paying career in computer programming is no longer out of your reach. Now you can get the practical training and experience you need to succeed in this top-growth field.

It's training that gives you real-world programming skills in four of today's hottest computer languages: BASIC, Pascal, C, and COBOL. Hands-on training that includes a powerful IBM AT-compatible computer, modem, and programming software you train with and keep. Comprehensive, at-home training that gives you the competitive edge to succeed in one of today's leading industries. The kind of experience-based training only NRI can provide.

As a trained computer programmer of the '90's, you can enjoy long-term career success. In fact, the Bureau of Labor Statistics forecasts that during the next 10 years job opportunities will increase by 71.7 percent for the skilled computer programmer. With NRI training you can be one of the increasing number of computer programmers using their skills to build a top-paying career—even a business of their own—in this professionally and financially rewarding high-tech field.

▼ The only programming course that includes a powerful AT-compatible computer system and programming software you keep

Right from the start, NRI training gets you actively involved in the challenge of real-world computer programming. You learn how to create the kinds of full-featured, powerful programs today's employers and clients demand. And, unlike any other school, NRI lets you experience first-hand the power of an IBM PC/AT-compatible computer system with modem, a full megabyte of RAM, disk drive, and monitor—all yours to train with and keep.

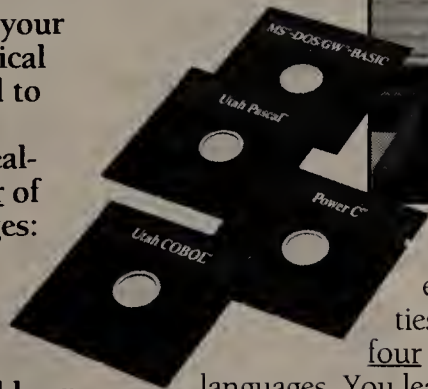

Plus you explore the extraordinary capabilities of not one or two but four in-demand computer languages. You learn to design, code, run, debug, and document programs in BASIC, Pascal, C, and COBOL. In the process you become uniquely prepared for the wide variety of programming opportunities available today.

▼ No previous experience necessary

Immediately, you start getting the money-making job skills you need to secure a future in computer programming—no matter what your background. With NRI training you move easily from computer novice to computer professional with step-by-step lessons covering program design techniques used every day by successful micro and mainframe programmers.

You'll find no heavy textbooks to plow through. No night classes to attend. Instead, NRI's at-home, step-by-step training covers all the bases, guiding you from the impor-

tant fundamentals to real-world methods and techniques. With the help of your NRI instructor—offering one-on-one, personal guidance throughout your course—you quickly gain the skills you need to handle with confidence a wide variety of programming applications. You even use your modem to "talk" to your instructor, meet other NRI students, and download programs through NRI's exclusive programmers network, PRONET.

▼ Send today for your FREE catalog

Now you can have the professional and financial rewards of a career in computer programming. See how NRI at-home training gives you the experience, the know-how, the computer, and the software you need to get started in this top-paying field. Send today for your FREE catalog.

If the coupon is missing, write to us at the NRI School of Computer Programming, McGraw-Hill Continuing Education Center, 4401 Connecticut Avenue, NW, Washington, DC 20008.

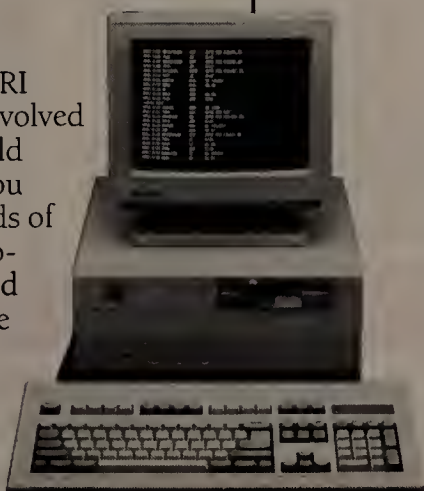

NRI Schools

McGraw-Hill Continuing Education Center
4401 Connecticut Avenue, NW, Washington, DC 20008



Check one free catalog only

- | | |
|--|--|
| <input type="checkbox"/> Computer Programming | <input type="checkbox"/> Microcomputer Servicing |
| <input type="checkbox"/> PC Systems Analysis | <input type="checkbox"/> Desktop Publishing and Design |
| <input type="checkbox"/> PC Software Engineering Using C | <input type="checkbox"/> Word Processing Home Business |

Name _____ Age _____
(please print)

Address _____

City _____ State _____ Zip _____

Accredited Member, National Home Study Council

45-43-081

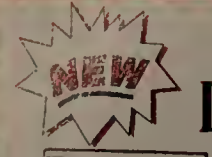

TEXAS INSTRUMENTS



TravelMate 3000 Notebook-Size Portable Computer

Features: • 80386SX 20 MHz Processor
• VGA Display • 8.5" x 11" x 1.8" • Internal
3.5" Floppy Drive • Limited 1 Year Warranty
• Weighs Only 5.7 Pounds

20 MB.....	\$2598.10	40 MB.....	\$3078.49
30 MB.....	\$2839.31	60 MB.....	\$3399.67

WHY PAY RETAIL?

CDW™ Sells For Less

AND SERVICES YOU BETTER

MAXSTATION 286 Today's Best Computer Value

Features: • 80286 Processor/Dual Processor Speeds (12.5 and 8 MHz)
• Total Exp.: (5) 4-16 Bit, 1-8 Bit • One 3.5" (1.44 MB) Floppy Disk Drive • One 5.25" (1.2 MB) Floppy Disk Drive • Internal 40 MB 28ms Hard Drive • 1 MB RAM • VGA Built-In • 4 Built-In Ports • Lotusworks™ Integrated Software Package • Operating System: MS-DOS™ 4.01, MS-DOS™ Shell, GW-BASIC™ • 1 Year Limited Warranty



CDW™ Price
\$849.46

MAGNAVOX

HARDWARE, SOFTWARE & PERIPHERALS AT DISCOUNT PRICES

NETWORKING PRODUCTS

NOVELL

ETHERNET Interface Connector (NE1000) ..	\$148.44
ETHERNET For PS/2 (NE/2) ..	251.72
ETHERNET Board (NE2000) ..	174.68
ETHERNET Eisa (NE3200) ..	756.18

3Com

3COM 3C503 TP 10 Base T ..	\$293.41
3COM 3C507 Ethernet Card ..	294.37
3COM 3C503 Etherlink ..	199.70
3COM 3C505B Ethernet Plus ..	583.81
3COM 3C523 MCA Ethernet ..	280.46
3COM Ethernet Repeater ..	848.31
3COM 3C501 Ethernet Board ..	322.73

THOMAS CONRAD

6142 Arcnet 8-Bit ..	\$93.09
6045 Arcnet 16-Bit ..	205.23
6142 TP+ Arcnet ..	103.53
6046 PS/2 Board Arcnet ..	228.16
6150-10 8 Port Smart Hub ..	509.65
6150-11 16 Port Smart Hub ..	691.01
6045 Twisted Pair Plus Ethernet ..	229.07
6046 Twisted Pair PS/2 Plus Ethernet ..	245.11
4045 16/4 Token Ring XT/AT ..	510.23

SMC ACCESSORIES

3508TP Concentrator AUI ..	\$747.73
3508TP Concentrator BNC ..	897.73
3508TP Concentrator TP ..	727.27
Active Hub 8 Port Twisted Pair ..	365.91

SMC INTERFACE CARDS

3008 Coax 8-Bit Ethernet ..	\$169.35
3008 TP 10 Base T 8-Bit Ethemet ..	199.48
3016 Coax 16-Bit Ethernet ..	174.40
3016 TP 10 Base T 16-Bit Ethernet ..	216.92
PC 500FS Coax Arcnet File Server 16-Bit ..	279.31
PC 500WS Coax Arcnet Workstation 16-Bit ..	169.41
PC 550FS TP Arcnet File Server 16-Bit ..	304.60
PC 550WS TP Arcnet Workstation 16-Bit ..	187.21
Eisa 3200 Arcnet Twisted Pair ..	736.08
Eisa 3200 Arcnet Coax ..	718.18

WESTERN DIGITAL

WD 16-Bit 10 Base T Ethernet ..	\$205.44
WD MCA PS/2 10 Base T Ethernet ..	224.42
WD Ethernet Plus/A PS/2 Coax ..	247.13
WD Elite 16-Bit Ethernet Plus Coax ..	173.84
WD Elite 8-Bit Ethernet Plus Coax ..	147.06
WD Elite Combo Ethernet TP, Coax, Aul ..	199.57

XIRCOM

Arcnet Pocket Adaptor Coax ..	\$239.20
Arcnet Pocket Adaptor RJ45 ..	239.77
Ethernet Pocket Adaptor Thin Coax ..	362.50
Ethernet Pocket Adaptor 10 Base T ..	373.86
Parallel Port Multi ..	75.00

ARTISOFT

E143 Ethernet Adaptor Kit ..	\$211.18
LANtastic Ethernet Starter Kit ..	477.27
LANtastic 2Mbps Starter Kit ..	339.53
LANtastic 2Mbps Adaptor ..	140.59

DCA

IRMA Trac T.R. Convertible ..	\$539
-------------------------------	-------

NETWORKING SOFTWARE



WordPerfect CORPORATION

ASHTON TATE dBase IV LAN Pak ..	\$626.37
BORLAND Paradox Network 5 User ..	614.40
BORLAND Ouattro Pro Network Node ..	193.18
BRIGHTWORKS PS Print ..	243.68
CC Mail Products ..	CALL
DELTA TECH Direct Net Menu ..	149.22
HARVARD GRAPHICS LAN Pack ..	CALL
LOTUS 1-2-3 2.3 Server ..	486.66
LOTUS 1-2-3 2.3 Network Node ..	282.88
LOTUS 1-2-3 3.1 Server ..	563.33
LOTUS 1-2-3 3.1 Network Node ..	349.50
LOTUS Freelance+ Server ..	456.93
LOTUS Symphony Server ..	599.13
MICRORIM Rbase V3.1 LAN 6 Users ..	589.00
MICROSOFT Word 5.5 Network Node ..	185.39
MICROSOFT Excel Network Nodes ..	255.60
NANTUCKET Clipper V.5.0 ..	485.50
NORTON LAMBERT PRODUCTS ..	CALL
NOVELL Network Access Server ..	CALL
ONTRACK Disk Manager For Novell ..	98.65
SOFTWARE PUB. Professional LAN Pack ..	309.13
WORD PERFECT 5.1 Network Node ..	179.11
WORD PERFECT Office 5-User V.3.01 ..	297.31
WORD PERFECT Plan Perfect Server ..	269.21
WORD PERFECT Plan Perfect Add. Nodules ..	109.75
WORD PERFECT Office 20PK V.3.01 ..	923.08
WORD PERFECT Draw Perfect Server ..	269.53
WORD PERFECT Draw Perfect Add. Station ..	165.93
XTREE Network ..	209.96

TAPE & FLOPPY DRIVES

IRWIN

IRWIN SX 40-120 MB Internal ..	\$262.40
IRWIN SXE 40-120 MB External ..	349.22
IRWIN 80 SX 80-250 MB Internal ..	374.18
IRWIN 80 SXE 80-250 MB External ..	489.63
IRWIN 2120 120MB Internal ..	507.53
IRWIN 445A 40MB External ..	449.60
IRWIN 485A 80MB External ..	533.70
IRWIN 6151 1 250MB Internal ..	879.33
IRWIN 6451E 250MB External ..	1069.77
IRWIN 785SP 80MB External ..	559.79

Call For Controllers, Accessory Kits and Tapes.



Mountain

MOUNTAIN 300MB External Filesafe ..	\$2498.19
MOUNTAIN 2.2 Gigabyte Ext. Tape Drive ..	4427.60
MOUNTAIN 250MB External Backup ..	609.22
MOUNTAIN 250MB Internal Backup ..	484.33
MOUNTAIN 1.3 Gigabyte External Filesafe ..	3574.20
MOUNTAIN 120MB Internal Tape Drive ..	249.80
MOUNTAIN 120MB External Tape Drive ..	448.88
MOUNTAIN 250MB Internal Filesafe ..	1138.89
MOUNTAIN 250MB External Filesafe ..	1509.66

Call For PS/2 Drives, Controllers, Accessory Kits and Tapes

COLORADO MEMORY

COLORADO DJ10 ..	\$239.72
COLORADO DJ20 ..	298.16
COLORADO OFA700 ..	708.42

Call For Accessories And Interfaces

PLOTTERS, DIGITIZERS & SCANNERS

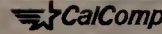

1023 ..	CALL	12 x 12 w/16 But ..	CALL
1025 ..	CALL	12 x 18 w/16 But ..	CALL
2024 Pacesetter D ..	CALL	2036 Pacesetter E ..	CALL

HURTA

1212IS1 ..	\$396.59	12 x 17 ..	\$598.35
------------	----------	------------	----------

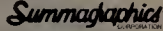

Summagraphics Summa II 12 x 12 ..	\$327.00
Summagraphics Summa II 12 x 18 ..	549.00
PANASONIC FX-RS307U 600x600 Scanner ..	2934.06
COMPLETE PC Full Page Scanner ..	533.30
EPSON ES300C Color Scanner ..	1185.00



DMP-61 ..	\$2610.66	DMP-62 ..	\$3394.15
DMP-61DL ..	3194.45	DMP-62DL ..	4096.28



HP7575A ..	\$3388.70
HP7475A ..	1199.00
HP7550A ..	2695.56
HP7570A ..	2729.30
HP7576-EXL ..	4456.04
HP SCANJET + ..	689.62

CAD MONITORS & CARDS

MITSUBISHI HL6915ATKL ..	\$1959.77
SIGMA Laserview 19" Full Page ..	1619.18
NEC Graphics Engine 256/16 ..	892.04 / 599.36
MITSUBISHI HL6935 ATKL 19" ..	1798.91
HERCULES GB1024 Graphics Station ..	653.40
CALCOMP 3401 ..	CALL

FAX & ACCESSORIES

A-B Switching Box / AB X Box ..	\$28.00 / 34.95
BROWN-WAGH Sound Blaster ..	155.95
CH PRODUCTS PS/2 Gamecard III ..	47.25
CH PRODUCTS XT/AT Gamecard III w/Y Cable ..	36.50
CH PRODUCTS Flight Stick ..	47.00
CH PRODUCTS Roller Mouse ..	85.40
CH PRODUCTS Mach III Joystick ..	31.20
COMPLETE PC Communicator ..	409.56
COMPLETE PC Portable Fax ..	307.67
Electronic 4-Way Switchbox Parallel ..	89.50
Electronic 4 to 2 Parallel Box ..	109.50
5TH GEN. Logical Connection 256K/512K ..	CALL / 438.59
INTELLICOM Long Link ..	117.70
KENSINGTON Masterpiece/Plus ..	84.70 / 97.64
KEYTRONICS 5151 IBM or AT&T ..	126.70
KEYTRONICS 101 ..	89.50
PANASONIC UF300 Plain Paper Fax ..	1545.18
PRACTICAL PERIPH. 32K Inline Parallel Buffer ..	123.60
PRACTICAL PERIPH. P/LINK Parallel Extender ..	99.50
ROLAND Sound Card L/ASYS ..	388.63
SOTA 2861-12 Accelerator ..	260.45
SOTA 3861-16 Accelerator ..	465.70
XT Power Supply 165 Watt ..	59.00
AT Power Supply 200 Watt ..	79.24

CompleteFax 9600 ..	399.50	SHARP FO-240 ..	599.35
JT-Fax 9600 ..	527.65	SHARP FO-334 ..	687.91
SHARP FO-216 ..			516.30

CD-ROM & OPTICAL DRIVES

HITACHI 3600/3650 ..	\$435.81 / 495.68
HITACHI 1700S External ..	447.42
MAGNAVOX 461RS Ext. w/CD Bundle ..	419.06
NEC CDR 36 External Portable ..	388.40
NEC CDR 73 External ..	597.22
NEC CDR 83 Internal ..	539.16
PANASONIC LF5010 Worm External ..	2089.91
PANASONIC LF7014 Worm Internal ..	1895.48
PANASONIC LF7010 Ext. 1 Gb Erasable Optical ..	2694.61
SONY CDU-7201 External CD-ROM ..	484.78
SONY CDU-53111 Internal CD-ROM ..	354.17
SONY CDU-54101 Internal SCSI CD-ROM ..	418.32
SONY SMO-5501 650M6 Erasable Optical Kit ..	3498.10
TOSHIBA XM3201 External ..	578.83
TOSHIBA XM3201 Internal ..	569.38
TOSHIBA XM5100 External ..	527.62
CD-ROM Software Bundle ..	169.00

AT CDW™ YOU GET MORE COMPUTING FOR YOUR BUCK. CALL NOW!

CDW™ means Service CDW™ means Savings CDW™ means Business CDW™ means Experience
 CDW™ means Technology CDW™ means Networking CDW™ means Computing PCW271

FREE TECHNICAL SUPPORT FOR CDW™ CUSTOMERS.

(800) 359-4CDW
 WE SELL NAME BRANDS FOR LESS!

ALWAYS WORKING TO KEEP YOUR COMPUTING ONE STEP AHEAD.



COMPUTER DISCOUNT WAREHOUSE™



Packard Bell Force 820 Personal Computer

- 80386SX Microprocessor
- 20 MHz • 16K Cache • 85 MB/20 ms HD Drive • 2 MB RAM (Max 16 RAM) • 5.25" 1.2 MB Floppy Drive • 3.5" 1.44 MB Floppy Drive • VGA 1024 x 768 • 512K Video Memory • 101 AT™ Keyboard
- 4 Exp. Slots (3 16-Bit, 1 8-Bit)
- Clock/Calendar • 2 Serial Ports, 1 Parallel Port, 1 Mouse Port, VGA Video Port • Novell Network Certified • 1 Year On Site Warranty • MS-DOS 4.01 GW-Basic • LotusWorks Integrated Software



\$1499.62 NOT AFFILIATED WITH ANY FORMER BELL SYSTEM ENTITY.

WHY PAY RETAIL?

CDW™ Sells For Less

AND SERVICES YOU BETTER

CDW : RATED #1 IN AN INDEPENDENT SURVEY OF READERS BY PC MAGAZINE

EPSON NB3s 386SX Notebook Computer

- Powerful 80386SX, 16MHz Microprocessor with 0 Wait States • Opt. Removable 20 MB or 40 MB Drive Module • Stnd. RAM of 1 MB, Exp. Up to 5 MB • Supports Sophisticated Graphical User Interfaces Like Microsoft® Windows™, MS-DOS® 4.01 • Removable Battery, Plus an AC Adaptor Stnd.
- One Year Limited Warranty

Epson NB3s 386SX.....CALL

20 MB (2.5") Removable HDD.....**CALL**

40 MB (2.5") Removable HDD.....**CALL**

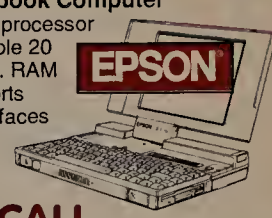

HARDWARE, SOFTWARE & PERIPHERALS AT DISCOUNT PRICES

COMPUTERS

MAGNAVOX	
MAX STATION 286 40MB VGA Interface.....	\$849.60
MAX STATION 386SX 80MB VGA Interface.....	1069.85
MAX STATION 386SX20 80 MB VGA Interface.....	1372.94

PACKARD BELL	
Packard Bell 286 Notebook.....	\$1595.44
FORCE III, 286/12, 40 Meg, 1 MB VGA Adapt.....	869.55
FORCE SX16, 44 MB, VGA Interface.....	1069.93
PB 386/33 2 MB, 3.5" & 5.25" Drives.....	1879.60
Force SX 20 MHz, 85 MB, VGA, 2 Drives.....	1499.62
Force SX 20 MHz, 130 MB, 2 Dr., Modem.....	1673.25
Force SX 20 MHz, 210 MB, 2 Dr., Fax Board.....	1998.70

Panasonic	
CF170 XT 10MHz 20MB Notebook Laptop.....	CALL
CF 270 286 16MHz 20MB VGA Notebook.....	CALL
CF 370 386SX 60 MB VGA Notebook.....	CALL

ALR	
ALR 386/33 Model 101.....	\$1655.70
ALR Business Versa 486/33 101.....	3279.60
ALR PowerFlex 286 40 MB.....	CALL
ALR PowerFlex 386SX Model I.....	1019.20

COMPAQ	
LTE 286 Mdl. 20.....	\$2051.00
LTE 386 60 MB.....	3938.00
LTE 286 Mdl. 40.....	2297.20
DP386S20 Mdl. 1.....	1886.20
DP386S20 Mdl. 60.....	4129.26

SAMSUNG	
SAMSUNG SD620 286/12 Base.....	\$614.60
SAMSUNG SD716 386SX 16 Base.....	897.27
SAMSUNG Notemaster SX16 20 MB.....	2285.70
SAMSUNG Notemaster SX16 40 MB.....	2495.42

TEXAS INSTRUMENTS	
TEXAS INSTR. TRAVELMATE 2000.....	\$1945.11
TM 3000 SX Notebook 20 MB.....	2598.10
TM 3000 SX Notebook 30 MB.....	2839.31
TM 3000 SX Notebook 40 MB.....	3078.49
TM 3000 SX Notebook 60 MB.....	3399.67

HP, IBM & COMPAQ MEMORY	
1MB Module CPO - 386, 386S, 20E/25E.....	\$105.23
2MB Memory Board CPO LTE 286.....	198.00
4MB Memory Board CPO LTE 286.....	607.00
4MB Memory Card CPO LTE 386S.....	1135.00
2MB Memory Board CPO SLT 386.....	279.00
4MB Memory Board CPO SLT 386.....	607.00
8MB Memory Mod CPO Deskpro/System Pro.....	CALL
4MB Module CPO - 386, 386S, 20E/25E.....	350.00
4MB CPO Exp. Bd. - 386S, 20E/25E.....	385.00
1 MB AST Cupid Simms.....	CALL
4 MB AST Cupid Simms.....	CALL
AST Exec 386SX 4 MB Module.....	CALL
2MB Upgrade HP LaserJet II / IID.....	189.00
1MB Upgrade HP LaserJet IIP / III.....	112.00
2MB Upgrade HP LaserJet IIP / III.....	189.00
4MB Upgrade HP LaserJet II / IID.....	352.00
IBM Personal System II Memory.....	CALL
2MB Memory Module IBM PS/2 Mod 70/50Z.....	160.00
1MB OKI Laser 400.....	159.00

KINGSTON FOR TOSHIBA	
2MB 1200XE.....	\$185.00
2MB 3100SX.....	185.00
4MB 3200SX.....	392.00
3MB 3200.....	273.00
2MB Memory Module TOSHIBA 5200.....	185.00
8 MB Memory Module TOSHIBA 5200.....	795.00

WYSE TERMINALS	
WYSE 50/60 Amber or Green.....	\$349.11 / 286.95
WYSE 85 / 30 Amber or Green.....	359.00 / 278.89
WYSE 185 VT320 Amber, Green or White.....	359.60
WYSE 150 Amber, Green or White.....	265.56

SURGE SUPPRESSORS	
CURTIS Ruby Plus.....	\$57.60
DATASHIELD S100.....	59.55
DATASHIELD S85.....	53.95
KENSINGTON MP+.....	96.00
KENSINGTON Remote.....	98.75
TRIPPLITE Isobar 4 Outlet/6 Outlet.....	44.25/49.10
TRIPPLITE Isobar 8 Outlet.....	57.30

DOT MATRIX & LASER PRINTERS

EPSON	
LX810.....	\$154.00
LO850.....	429.00
LO1050.....	569.00
FX1050.....	399.00
LQ1010.....	349.00
LO200.....	CALL
DFX 5000/8000.....	CALL

NEC	
Silentwriter 90.....	\$1549.50
P6200 24-pin.....	467.70
P3300 24-pin.....	378.33
LO510.....	\$249.00
FX850.....	287.00
LQ2550.....	849.00
EPL 7000 Laser.....	799.00
EPL 7500 Laser PS.....	CALL
LO200.....	225.00
DFX 5000/8000.....	CALL

DICONIX by KODAK	
150 Parallel /150 Serial.....	\$329.07 / 339.07

OKIDATA	
ML182 Turbo.....	\$226.66
OKILASER 400.....	627.08
OKILASER 800.....	926.96
OKILASER 820.....	1238.88
OKILASER 840.....	1629.55
ML390+.....	\$439.22
ML391+.....	596.41
ML380.....	234.61
ML393+.....	929.90
ML393+ Color.....	999.50
ML321.....	438.44

Panasonic	
1124 I.....	\$279.69
1123.....	229.00
4420 Laser Printer.....	789.50
1624.....	\$359.39
1180/1654.....	149.99/CALL

HEWLETT PACKARD	
H-P LaserJet Model IIID.....	CALL
H-P Deskjet 500/H-P Laserjet IIP.....	485.50/849.00
H-P Laserjet III.....	CALL
H-P Paintjet.....	958.85
H-P Paintjet XL.....	1685.78
H-P LaserJet IIIP.....	CALL
CANON BJ10E Bubble Jet.....	323.68
CITIZEN GSX 140.....	289.44
OMS PS410.....	1977.00
PACIFIC DATA 25 in 1 Cart. LAS3.....	\$265.91
PACIFIC DATA Page Postscript 4 HP LAS3.....	349.44
PACIFIC DATA Connect 169 256K.....	272.79
PACIFIC DATA 1 MB Upgrade for LaserJet II.....	169.00
PACIFIC DATA 1 MB for 2P / III.....	CALL
POSTSCRIPT CART. W/2MB HP LAS2.....	339.00
CPI JETMEMORY 1MB for HP IIP/IIID.....	129.60
CPI JETPAGE for HP IIP/IIID/III Postscript.....	208.72
CPI SUPERSET+ 425 Fonts for all HP Lasers.....	209.67

DRIVES, TAPES & CARDS	
COMPAQ 360KB (SLT).....	\$179.00
COMPAQ 1.2 MB/360KB (SLT).....	209
COMPAQ 360KB (LTE).....	189.00
COMPAQ 1.2 MB/360KB (LTE).....	209.00
CONNER 40 MB / 120 MB.....	279.42 / 449.83
CONNER 84 MB / 204 MB.....	397.35 / 695.41
IOMEGA B144/B44 Trans.....	799.11 / 889.73
PLUS Hardcard IIXL i05MB.....	589.46
PLUS Hardcard IIXL 50 MB.....	388.75
SYSGEN 5.25" /3.5" External Floppy.....	209.25
PACIFIC RIM 5.25" External Floppy for Laptops.....	185.56
TOSHIBA (All Models) EPSON LT360KB.....	179.00
TOSHIBA 1.2 MB/360KB.....	189.00

Seagate	
ST225 20 MB.....	\$182.35
ST238 30 MB.....	198.82
ST4383E 329 MB 1392.94.....	1392.94
1102A 84 MB.....	319.20
ST1144A 124 MB IDE.....	439.57
SEAGATE 4096 80.....	\$479.74
SEAGATE ST-251-1.....	243.10
ST4182E 160 MB.....	874.44
ST157A 44 MB 3.5.....	199.17
ST1144A 124 MB IDE.....	439.57

MATH COPROCESSORS	
INTEL 8087-2.....	\$115.90
INTEL 287-XLT.....	193.55
INTEL 80287-XL.....	189.50
INTEL 80387-20.....	359.65
INTEL 80387-SX.....	\$294.82
INTEL 387SX20.....	312.24
INTEL 80387-25.....	449.00
INTEL 80387-33.....	548.20
1684-7 340 MB.....	\$1323.52
1558 338 MB ESDI.....	1088.14

MODEMS & COMMUNICATIONS

intel	
2400 Internal.....	\$139.75
2400B MNP.....	193.72
9600 External.....	495.40
2400 External.....	\$167.94
2400 External MNP.....	217.11
2400 Internal.....	223.22

PRACTICAL PERIPHERALS	
2400 V.42 Int.....	\$169.11
2400 V.42BIS Ext.....	199.50
9600 V.32/42BIS.....	447.67
2400 Int.....	\$128.88
2400SA.....	167.97
Pocket 2400.....	99.50

HAYES	
2400 External.....	\$325.84
ULTRA 9600 Ext.....	629.40
2400 Internal.....	\$224.45
2400 V.42 Ext.....	399.40

Robotics	
Courier 2400.....	279.60
Dual 14,400 HST.....	809.65
V.32 9600E.....	573.03
14,400 HST.....	569.00

MHz	
2400 for TOSHIBA.....	139.33
2400 for COMPAQ LTE.....	139.00
CPI VIVA 2400 Internal.....	85.40
CPI VIVA 2400 External Faxsend Modem.....	112.50
CPI VIVA 2400 External Hardware MNP.....	149.73

MULTI-TECH	
MULTI-TECH 224EH 2400 Ext.....	\$299.50
MULTI-TECH 696EA 9600.....	473.03
MULTI-TECH MT932EAB 9600.....	533.70

BOARD & COMM PRODUCTS	
AST 5251-11+ Enhanced Local.....	\$497.75
DIGIBOARD PC/8i Intelligent 8 Serial.....	799.60
DIGIBOARD PC/16i Intelligent 16 Serial.....	1172.34
DIGIBOARD PC/8 8 Serial Ports.....	424.73
EVEREX 2400 Internal Modem.....	109.75
EVEREX 2400 External MNP w/Sft.....	189.88
EVEREX 2400 MNP Internal.....	145.34
IRMA III 3270 PS/2 MCA Board.....	412.35
IRMA III 3270 XT/AT.....	409.60
WORLD PORT Modem/Fax Ext.....	474.55
AST SixPack 286 OK.....	96.60
INTEL Above Board Plus 8 w/2 MB.....	399.71
INTEL Above Board Plus 512K.....	279.16
INTEL Inboard 386/PC.....	469.60
INTEL SatisFAXtion Fax Board.....	374.50

BATTERY BACKUP AND UPS

AMERICAN	
AME-1200VX.....	\$735.95
AME-360SX.....	206.89
AME-450AT.....	261.79
AME-Smart 400.....	305.42
AME-520ES.....	\$321.83
AME-800RT.....	552.50
AME-600LS.....	449.19
AME-Smart 900.....	609.12

Durant Technologies, Inc.	
BPS-300.....	\$219.55
BPS-800.....	533.30
BPS-550.....	\$356.55
BPS-1200.....	706.66
BC-450.....	\$259.22
BC-1200 LAN.....	620.22
BC-325 Watt BU.....	209.72
4 Outlet.....	\$44.25
LC-1200.....	139.77
Command Console.....	69.50

MICE

Super Mouse II W/Windows.....	\$87.83
LOGITECH Trackman Portable.....	CALL
LOGITECH C9 Serial /PS/2.....	69.00
LOGITECH Mouseman RightHand.....	74.50
LOGITECH ScanMan PC/Scanman PS/2.....	177.89/214.50
LOGITECH Trackman Serial.....	82.93
MICROSOFT Mouse (Bus Version).....	103.53
MICROSOFT Mouse (Serial Version).....	103.53
MICROSOFT Mouse w/Windows 3.0.....	147.50
MICROSOFT Ball Point Mouse.....	CALL

MOST ORDERS RECEIVED BY 5:00 P.M. C.D.T. SHIP SAME DAY

IF YOU FIND A BETTER PRICE CALL US BEFORE YOU BUY
2840 MARIA, NORTHBROOK, IL 60062 FAX (708) 291-1737

PC Magazine says... "You may find a better deal here than anywhere else."

WHY WAIT? CALL COMPUTER DISCOUNT WAREHOUSE™ NOW!

CDW™ EXTENDED HOURS
Sales 7:30-7:30 CDT Mon-Fri.
9:00-3:30 CDT Sat.
Tech Support 9:00-5:00 CDT Mon-Fri.



(800) 359-4CDW



Credit Card charges are not submitted until time of shipment. Shipping and handling additional. On all hard drive orders under \$200.00 please add \$5.00 handling fee. Non-defective returns subject to restocking fee. All prices reflect 3% discount for cash. Allow 10 business days for shipping when paying by personal check. Software chips and other electronic components are not returnable. All pricing subject to change. © Registered trademarks of IBM and COMPAQ.

In Illinois FAX
(708) 498-1426 (708) 291-1737

Credit card charges are not submitted until time of shipment.

Apply for the CDW™ Credit Card
VISA DISCOVER MasterCard AMERICAN EXPRESS CDW
High Volume Bids Invited

PCW271

Smart PC Buyers ... Call Blackship.

If you are looking for the best buy in a PC for your office or your home, the name to remember is Blackship. We have the "Best Buy" reputation that is unbeatable. Not only can you virtually design the configuration you want and need to grow with, you can buy it at off-the-shelf prices.

You always get top quality and quick turnaround on your order when you call our toll-free order desk number.

All Blackship computers have :

- 1-year parts and labor warranty
- 1-year GE on-site service at most locations
- 30-day money-back guarantee
- Unlimited toll-free technical support

Don't just take our word for it.



"Blackships' 386-25... fine-performing machine... reasonable price... good customer service... a good buy for workstation shoppers"—*PC Magazine 1/25/91*

"The Blackship 386SX-20 is a highly desirable system both in performance and price."—*PC Magazine 11/27/90*

"Of our seven contenders, the Blackship 486-25 machine earned the top value."—*InforWorld 3/12/90*

"... its price/performance ratio easily justifies PC Worlds Best Buy recommendation."—*PC World 8/88*



ONSITE SERVICE
GE Computer Service

Recent Awards



For all your networking and custom configurations, call us.

Toll-Free Order Desk
1-800-877-6249



BLACKSHIP
COMPUTER SYSTEMS, INC.

Notebook/Laptop

386SX/20 Laptop	\$2395
386SX/20 Notebook	\$2295
286/12 Laptop (CGA)	\$1595

Laptop

- 1 MB RAM
- 1.44 MB 3.5" Floppy Drive
- 40 MB IDE Hard Drive
- VGA 640 x 400, 16 Shades of Gray
- 2 Serial, 1 Parallel Port
- MS DOS 4.01
- Ni-Cd Rechargeable Battery
- Weight 14.7 lbs

Notebook **NEW**

- 1 MB RAM
- 1.44 MB 3.5" Floppy Drive
- 20 MB 17 ms IDE Hard Drive
- VGA 640 x 400, 32 Shades of Gray
- 1 Serial, 1 Parallel Port
- MS DOS 4.01
- Carrying Case
- Weight 6.5 lbs

486 SVGA Systems

- 64K Cache RAM
 - 4 MB RAM
 - 1.2 MB 5.25" Floppy Drive
 - 1.44 MB 3.2" Floppy Drive
 - 200 MB 15 ms IDE Hard Drive
 - 16-bit VGA with 1 MB
 - 14" 1024 x 768 SVGA Monitor
 - 1 Parallel, 2 Serial, 1 Game Port
 - 101-key Keyboard
 - MS DOS 3.3 or 4.01
- | | |
|-------------|--------|
| 486/25 ISA | \$3195 |
| 486/25 EISA | \$3895 |
| 486/33 ISA | \$3595 |
| 486/33 EISA | \$4395 |

386SX/286 Systems

- 2MB RAM
 - 1.2 MB 5.25" Floppy Drive
 - 1.44 MB 3.2" Floppy Drive
 - 40 MB IDE Hard Drive
 - 16-bit VGA with 256K
 - 14" VGA Color Monitor
 - 1 Parallel, 2 Serial, 1 Game Port
 - 101-key Keyboard
 - MS DOS 3.3 or 4.01
- | | |
|-----------------|---------------|
| 386SX/20 | \$1595 |
| 386SX/16 | \$1445 |
| 286/16 | \$1345 |
| 286/12 | \$1295 |

386 SVGA Systems

- 64K Cache RAM
 - 4 MB RAM
 - 1.2 MB 5.25" Floppy Drive
 - 1.44 MB 3.2" Floppy Drive
 - 120 MB 18 ms IDE Hard Drive
 - 16-bit VGA with 1 MB
 - 14" 1024 x 768 SVGA Monitor
 - 1 Parallel, 2 Serial, 1 Game Port
 - 101-key Keyboard
 - MS DOS 3.3 or 4.01
- | | |
|--------------------------|---------------|
| 386/40 NEW | \$2595 |
| 386/33 | \$2395 |
| 386/25 | \$2295 |
| 386/25 (No Cache) | \$2195 |

K E N O S H A

We Export!

EPSON PRINTERS

LX 810/FX 850 —	\$155/\$289
FX 1050 — 264 cps, 54 nlq	\$395
LQ 200 —	\$229
LQ 510 — 225 cps, 75 nlq	\$245
LQ 850 — 330 cps, 88 nlq	\$435
LQ 860 — Color	\$549
LQ 1010 — 225 cps, 75 nlq	\$359
LQ 1050 — 330 cps, 88 nlq	\$569
LQ 2550 — 400 cps, 108 nlq	\$849
EPL7000 — Laser Printer	\$789
DFX 5000 — 533 cps, 160 nlq	\$1279
DFX 8000 — 1066 cps, 160 nlq	\$2139

KENOSHA COMPUTER CENTER

SALES LINE OUTSIDE WISCONSIN

1-800-255-2989

Shipping, customer service &
technical assistance call
414-697-9595

Fax 414-697-0620



AST COMPUTERS

AST Premium Exec Notebook	CALL
386 BRAVO 5V — w/40 MB, & VGA card	\$1799
386 PREMIUM II SX — 20 Mhz w/40 MB & VGA Card	\$1999
386-33 CLEM MOD 5 w/90 MB & VGA card	\$4049
486-25 BRAVO MOD 5 w/90 MB & VGA card	\$3749
All other models & configurations	Call

COMPAQ

286N w/40MB	\$1599
286N w/100MB	\$1999
386S w/40MB	\$2099
386S w/110MB	\$2399
386E w/40MB	\$2599
386E w/110MB	\$2799
386 25E w/100MB	\$3799
486 All Models	CALL
SLT 286 Laptop	CALL
SLT 386 Laptop	CALL
Compaq LTE	CALL
Compaq LTE 286	CALL
Compaq LTE 386	\$3649

FOR ALL YOUR LASER PRINTER NEEDS

HEWLETT-PACKARD

LaserJet IIIP w/toner	\$1069	LaserJet III w/toner	\$1545
LaserJet IIP w/toner	\$869	DeskJet Plus 500	\$499
25-in-1 Font	\$249	1 MB Upgrade	\$99
172 fonts & symbol sets		2 MB Upgrade	\$139
Pacific Page	\$329	4 MB Upgrade	\$229
PostScript® language emulation in a cartridge		Pacific Type	\$259
Complete Font Library	\$259	40 additional scaleable fonts for Laser Jet III	
51 scaleable fonts for Laser Jet III		Pacific Page XL	\$699
Plotter in a Cartridge	\$229	Includes Intel's 960 Micro- processor and 2 MG Memory.	
Plotter emulation for the Laser Jet Series II™		Up to 8 times faster than competing products.	

NETWORKING

Advanced Network 2.15	\$2099
SFT Network 2.15	\$2899
Entry Level 286 Starter Kit 4-Wet	\$499
Entry Level 286 Starter Kit 8-Wet	\$1199
NE1000	\$149
NE2000	\$179
ARCNET PC 130	\$99
ARCNET PC 130E	\$129
ARCNET Active Hub/Passive Hub	\$289/79
ARCNET PC 500FS	\$305
ARCNET PC 500WS	\$235
Thomas Conrad 6142 8-bit	\$119
Thomas Conrad 6045 16-bit	\$259
LANTASTIC	
2MB Starter Kit/Adapter	\$379/279
10MB Ethernet Starter Kit	\$519
Adapter	\$245
Accessories	Call

PANASONIC

1123/1124i	\$229/275
1180/1191	\$149/219
1624/1654	\$349/539
4420/4450I	\$799/1099
4455 Postscript Laser	\$1999
1mg. Upgrade for 4420 & 4450I	\$139
C1381 1024 x 768 VGA Monitor	\$329
C1391 Multisync	\$499
CF170 Notebook	Call
CF270 Notebook	Call

LAPTOPS TOSHIBA

T2000	CALL
3100SX/3200SX	CALL
5200 40/100	CALL
All Other Models	CALL

NOTEBOOKS

AST Premium Exec	CALL
Panasonic CF170	CALL
Panasonic CF270	CALL
Epson 386SX Notebook	CALL
Everex Tempo LX	CALL

LAPTOP MEMORY

1 MB Compaq LTE 286	CALL
2 MB Compaq LTE 286	CALL
1 MB Compaq SLT 286	CALL
2 MB Toshiba T1600	CALL
2 MB Toshiba T3200SX	CALL
2 MB Toshiba 5100	CALL
2 MB Toshiba 5200	CALL
All other models	CALL

LAPTOP MODEMS

Toshiba 2400 Internal	\$129
Zenith, Compaq, NEC, Sharp, Epson and other models	CALL

DIGITIZERS

Summasketch 12x12	\$319
Summasketch 12x18	\$549

HARD DISKS

SEAGATE

20MB w/contr. ST225	\$239
30MB w/contr. ST238	\$259
40MB for AT ST251-1	\$249
40MB 157A Kit	\$259
80MB for AT ST296N Kit	\$379
89MB 1102A	\$299
138MB ESDI-SG1156E	\$899

PLUS HARD CARDS

20MB/40MB	\$489/\$549
80MB	\$589
Hardcard 50 XL	\$379
Hardcard 105MB	\$569

CONNER

40MB/100MB	\$229/\$409
------------	-------------

TAPE BACK UP

Maynard 60MB External	\$829
Mountain 40MB Internal	\$299
Mountain 40MB External	\$559
All other models	CALL

MONITORS

Mitsubishi EGA	\$339
Mitsubishi Diamondscan	\$489
Mitsubishi HL 6605 16"	\$1049
Mitsubishi HL 6935 20"	\$1789
NEC Multisync IIA	\$449
NEC Multisync IIID	\$599
NEC Multisync IVD	\$979
NEC Multisync VD	\$2099
Panasonic C1381 1024x768	\$329
Panasonic C1391 1024x768	\$499
All Goldstar Monitors	CALL

CMS ENHANCEMENTS

Int. and ext. hard drive kits AT and XT compatible	from \$249
PS/2 internal hard drive kits	
20MB and up	from \$329
PS/2 external hard drive	
90MB and up	from \$1049
External floppy drives for PS/2	
AT, XT and laptop	from \$179
Laptop hard drive for Tandy, NEC, Toshiba, Zenith, Compaq	CALL
Fax Modem and Pocket Fax	CALL

GRAPHICS CARDS

ATI Basic 16	\$89
ATI Wonder Plus VGA	\$189
Everex Viewpoint VGA	\$179
Everex VGA VRAM	CALL
NEC Graphic Engine	\$899
Orchid Pro Designer II	\$279
Orchid Pro VGA w/512K	\$289
Paradise VGA 1024	\$149
Paradise VGA Plus	\$139
Paradise VGA Plus 16	\$179
STB Power 1MG	\$199
Hercules Station	\$649

OKIDATA PRINTERS

ML320	\$319
ML321	\$439
ML380	\$219
ML390	\$439
ML391	\$391
ML393	\$919
OLC 400 Laser	\$639
OLC 800 Laser	\$949
OLC 820 Laser	\$1249
Okilaser 400 1MB Upgrade	\$139
Okilaser 400 2MB Upgrade	\$185

intel



Intel Snap-In 386	\$369
80287-XL	\$179
80387-16MHz/SX	\$309/\$279
80387-20MHz/SX	\$299
80387-25MHz	\$439
80387-33MHz	\$549
Intel 9600 Modem	\$479
Multifunction Boards	CALL
Satisfaxion (Fax Modem)	\$369

MEMORY UPGRADES

COMPAQ MEMORY

386 1MB/4MB MODULES	\$149/\$349
386 1MB/4MB BOARDS	\$199/\$399
SLT 286 1MB	\$199
LTE 286 2MB	\$195
Other Models	Call

IBM UPGRADES

2 MB Kit 30-286	\$189
2-8 MB BD w/2MB 50,60,70 & 80	\$449
All Others	Call

CHIPS & LASER UPGRADES

All Simm & Drams	Call
Panasonic 1MB/2MB	\$139/\$189
OKI LASER 400 1MB/2MB	\$139/189
IBM 1MB/2MB	\$135/185
Epson EPL 6&7000 Series	\$Call
TI Micromaster	\$149

MODEMS

Everex 2400 int/ext	\$89/155
Hayes V Series int	\$499
Hayes Ultra 9600	\$649
Intel 2400 ext	\$159
Intel 2400 ext w/MNP	\$209
Intel 9600 ext	\$479
Practical Perp. Pocket Modem	\$109
US Robotics 2400 int/ext	\$129/149
US Robotics 14.4 int/ext	\$549/579
US Robotics V-32 int/ext	\$549/599
US Robotics Dual Std.	\$899

Prices and
availability
subject to
change

**KENOSHA
COMPUTER CENTER**
2133 91st St.
Kenosha, WI 53140

No charge for MasterCard or Visa; American Express add 5%. We will ship COD on a cash or cashier's check basis only. Shipping & handling 3% — \$6 minimum; AK and HI slightly higher. 15% restocking charge on returned items. Purchase orders accepted from Fortune 1000, Government institutions, schools and universities. 2% shipping discount available on orders over \$2000 if prepaid by check.

C O M P U T E R C E N T E R

Circle 41 on reader service card

WE ACCEPT PO'S
FROM QUALIFIED FIRMS

MEMORY

NO SURCHARGE
FOR MC, VISA & DISCOVER

★ ★ CALL TOLL-FREE 800-433-3726 ★ ★

★ SOFTWARE BLOWOUT ★

Wordstar 2000 3.5 • Rev A
\$99.00

Wordstar 5.5 • Retail Packaged • **\$99.00**

TURBO 25

Gives You 150 Fonts
for H.P. Laser Printer
\$119.00

INTEL 8087-3
\$59.00

Individual D-RAM Chips

MEMORY FOR IBM & APPLE

	60NS	70NS	80NS	100NS	120NS	150NS
1Meg x 1	5.75	5.50	5.15	4.50	4.40	—
4Meg x 1	—	—	34.00	—	—	—
1Meg x 4	—	—	31.00	—	—	—
1Meg x 4 (Zip Pack)	—	—	29.00	—	—	—
256 x 4 (Video Zip)	—	—	—	16.95	—	—
256 x 4	6.00	5.90	5.80	5.60	5.50	—
256 x 1	3.00	2.80	2.20	1.90	1.80	1.70
64 x 4	—	—	3.25	3.00	—	—
64 x 1	—	—	—	1.50	1.40	1.30

SIMM MODULES (Add \$5⁰⁰ for SIPP)

	60NS	70NS	80NS	100NS	120NS	150NS
1Meg x 9 (IBM)	58.00	54.00	49.00	47.00	—	—
4Meg x 9 (IBM)	—	219.00	199.00	—	—	—
256 x 9 (IBM)	23.00	21.00	18.00	17.00	16.00	15.00

INTEL Math Chips

8087	59.00	80287-XLT	89.00
8087-2	79.00	(50% faster)	—
8087-1	119.00	80387-16	189.00
80287-6	79.00	80387-16SX	129.00
80287-8	109.00	80387-20	209.00
80C287A	169.00	80387-20SX	149.00
80287-10	139.00	80387-25	245.00
80287-XL- (50% faster)	89.00	80387-33	279.00

IIT ADVANCED MATH CO-PROCESSOR

- 2-3 times faster than Intel • Plug & object code compat. w/Intel
 - 5 Year Warranty
- | | |
|---------------------|-----------------------|
| 2C87-8MHz — 129.00 | 2C87-12.5MHz — 179.00 |
| 2C87-10MHz — 155.00 | 2C87-20MHz — 249.00 |

CYRIX FASMATH PROCESSOR

- Programs executed up to 3X faster • Plug & object code compat. w/Intel
 - PC Week™ rated it #1 over all math chips
 - 5 Year Warranty
- | | |
|----------------------|--------------------------|
| 83D87-16MHz — 270.00 | 83D87-33MHz — 449.00 |
| 83D87-20MHz — 289.00 | 83S87-16SX Ver. — 249.00 |
| 83D87-25MHz — 369.00 | 83S87-20SX Ver. — 279.00 |

AST MEMORY MODULES

MODEL#	AMT. UPGRADED	AST PART#	PRICE
Premium 386/25, 16 SX	1Meg	500718-001	65.00
Premium 386/33	1Meg	500718-002	69.00
Premium 486/25T, 25TE,	1Meg	500780-003	WP8 85.00
25, 25E, 33T	4Meg	500780-004	WP8 279.00
	8Meg	500780-001	WP8 599.00

ZENITH MEMORY UPGRADES

MODEL#	AMT. UPGRADED	ZENITH PART#	PRICE
Z386/33	1Meg	ZA3800ME	89.00
	2Meg	ZA3800MG	139.00
Z386/25,20	1Meg	ZA3600ME	89.00
	2Meg	ZA3800MG	139.00
	4Meg	ZA3800MK	309.00
Z248, Z286LP Z386SX	2Meg	Z-605-1 modules	199.00
Turbo Sport 386, 386E	1Meg	ZA3034ME	219.00

BOCA AT PLUS

16 BIT MEMORY BOARD FOR 286, 386 AT
OK-8Meg Board • 4.0 LIM Compatible • New 5 Year Warranty
Conventional, Expanded and Extended Memory
Supports DOS, OS/2, LIM/EMS & EEMS
Versatile Split Memory Addressing
Operates with CPU Speeds to 33 MHz
Supports Desqview, Multitask operations
OK — \$119.00 2 Meg — \$209.00
4 Meg — \$299.00 8 Meg — \$485.00
Board made by Boca Research, AT plus
BOCA AT PLUS I/O 1 par., 1 ser., 0-4 meg 159.00
BOCA AT I/O 44 2 ser. ports, 2 par. ports 79.00

BOCA XT 8 BIT BUS

• Expanded memory for XT • Lim 4.0 compat. 0-2Meg • Uses 256x1-150
0-K \$109.00 1Meg \$170.00 2Meg \$229.00

IBM PS/2 SIMM MODULES

IBM PART NO.	WORKS WITH MODEL NO.	L.A. TRADE'S COMPT. PRICE
30F5348 (512K)	30-286	38.00
30F5360 (2Meg)	30-286, 50 MTHR BD.	115.00
6450375 (1Meg)	80-041	59.00
6450379 (2Meg)	80-111, 311	139.00
6451060 (4Meg)	80-A21, A-61, 80-A31, 80-111, 80-311	269.00
6450603 (1Meg)	50Z, 55SX, 70-E61, 0-61, 70-121, P-70	59.00
6450604 (2Meg)	50Z, 55SX, 55LS, 70-E61, 0-61, 70-121, P-70	109.00
6450605 (1-32Meg)	603, 604, 30F2933, 8Meg. Mod.	249.00
(8Meg)	Module for our 605 EXP. BD "It Works"	595.00
6450608 (2Meg)	70-A21, A-61, B-21, B-61	115.00
78X8955 (128K)	25	35.00
30F2933 (4Meg)	65SX, 55SX, MTHR BD., 34F3077, 3453011, 605 EXP. BD.	269.00
1383679 (512K)	P/S1	59.00
(2Meg)	P/S1	159.00
6450092 (2Meg)	90, 95, P-75	139.00
6450128 (4Meg)	90, 95, P-75	389.00

Other PS/2 models not shown please call for quote
Please call for any questions on these SIMM Modules

COMPAQ MEMORY MODULES

MODEL#	AMT. UPGRADED	COMPQ PART#	PRICE
System Pro	2Meg Module	115144-001	119.00
	8Meg Module	116561-001	829.00
	32Meg Module	116568-001	4500.00
DeskPro 486/25	2Meg Module	115144-001	119.00
	8Meg Module	116561-001	829.00
DeskPro 386/33	2Meg Module	115144-001	119.00
Sys. Pro, DP 386/33, DP 486/25	Expansion Bd	116569-001	479.00
DeskPro 386/25	1Meg Module	113131-001	59.00
	4Meg Module	113132-001	215.00
DeskPro 386/20	1Meg Module	113131-001	59.00
	4Meg Module	113132-001	215.00
DeskPro 386S	1Meg Exp 8d	113633-001	129.00
	4Meg Exp 8d	113634-001	309.00
	1Meg Module	113646-001	79.00
	4Meg Module	112534-001	239.00
DeskPro 386/20E	1Meg Exp 8d	113644-001	129.00
DeskPro 386/25E	4Meg Exp 8d	113645-001	309.00
	1Meg Module	113131-001	59.00
	4Meg Module	113132-001	215.00
DeskPro 286N	1Meg Module	118688-001	59.00
	4Meg Module	118690-001	279.00
DeskPro 386N	1Meg Module	118688-001	59.00
	2Meg Module	118689-001	119.00
	4Meg Module	118690-001	279.00
DeskPro 386/16	1Meg Kit	108071-001	119.00
	4Meg Kit	108072-001	269.00
	1-2Meg Exp 8d	108069-001	309.00
	4-8Meg Exp 8d	108070-001	829.00
DeskPro 286E	1Meg Module	113131-001	59.00
	4Meg Module	113132-001	215.00
DeskPro 286	512K Kit	113012-001	79.00

MEMORY UPGRADES FOR COMPAQ PORTABLES AND LAPTOPS

Portable 386	1Meg Kit	107651-001	149.00
	4Meg Exp 8d	107653-001	519.00
	4Meg Daght. 8d	107654-001	519.00
Portable III	2Meg Kit	107332-001	119.00
Compaq SLT/286	1Meg Module	110235-001	129.00
	4Meg Module	110237-001	529.00
Compaq SLT/386	1Meg Module	118303-001	179.00
	2Meg Module	118304-001	359.00
	4Meg Module	118305-001	629.00
Compaq Lte 286	1Meg 8d	117081-001	89.00
	2Meg 8d	117081-002	159.00
Compaq Lte 386S20	4Meg Module	121125-002	629.00
Compaq Lte 386S/20	1Meg Module	121125-001	249.00
Compaq Lte 286S/20	2Meg Module	—	429.00

MEMORY BOARDS

IBM Compatibles, Compaq & PS/2

EXT/EXP MEMORY BOARD, BOCA 50Z

0-2Meg for PS/2 50, 50Z, 60 • 0 wait state ram • Uses 1Megx1-80NS
0-K board only \$129.00 2Meg with board \$224.00

• WE WILL TRY TO MATCH OR BEAT ANY ADVERTISED PRICE •

All products Brand New & Guaranteed • We Buy Excess Inventory
Trademarks are registered with their respective companies



20950 S. Normandie, Unit M • Torrance, CA 90502

LAPTOP SPECIALS

T1000 SE/XE/LE	Everex Tempo Lx	TI Travelmate 3000
2Meg	2Meg	2Meg
199.00	179.00	199.00

TOSHIBA LAPTOP MEMORY

LAPTOP MODEL #	AMT UPGRADED	TOSHIBA PART #	L.A. TRADE'S COMPT. PRICE
T1000SE/XE/LE	1Meg	PC14-PA8311U	119.00
	2Meg	PC14-PA8312U	199.00
T1200XE	2Meg	PC13-PA8306U	129.00
T1600	2Meg	PC8-PA8302U	129.00
T2000SX	1Meg	PC14-PA8316U	139.00
	2Meg	PC14-PA8317U	209.00
T2000SX/T1000LE	4Meg	PC14-PA8314U	489.00
	8Meg	PC14-PA8315U	729.00
T3100E	2Meg	PC9-PA8340UT	129.00
T3100SX	2Meg	PC15-PA8308U	129.00
	4Meg	PC15-PA8310U	295.00
T3200	3Meg	PC6-PA7137U	205.00
T3200SX	2Meg	PC12-PA8307U	129.00
	4Meg	PC12-PA8309U	295.00
T3200SXC	2Meg	PC19-PA8318U	139.00
	4Meg	PC19-PA8319U	319.00
T5100	2Meg	PC7-PA8301U	129.00
T5200, 5200C	2Meg	PC10-PA8304U	129.00
	8Meg	PC10-PA3313U	769.00
T8500	2Meg	PC10-PA8304U	129.00
	8Meg	PC10-PA3313U	769.00

BRANDNAME LAPTOP MEMORY

Zenith Supersport 286	1Meg	ZA-180-66	125.00
NEC Prospeed 286	1Meg	PC21-21	159.00
NEC Prospeed 286	4Meg	PC21-22	505.00
NEC Prospeed 386	2Meg	PC31-21	199.00
NEC Prospeed 386	8Meg	PC31-22	849.00
Sharp PC-6220	1Meg	CE 6218	159.00
TI Travelmate 2000	1Meg	2568034-0001	149.00
TI Travelmate 3000	2Meg	2566996-1	199.00
Zenith Super Sport — 286, 286E	1Meg	ZA-180-66	125.00
286E, SX	2Meg	ZA-180-64	199.00
SX Alpha	2Meg	ZA-180-86	199.00
Everex Tempo LX	2Meg	PCA 00053-00	179.00
AST Notebook	1Meg	500814-001	139.00
AST Notebook	4Meg	500814-003	399.00
AST Premium Execc	—	386SX20	519.00
Sanyo 17/18 N8	2Meg	M8C-N8MEM2	199.00
Panasonic CF170, CF270	1Meg	CF-8A165	179.00

LASER PRINTER MEMORY UPGRADES

	HP Laser Jet II, IID, III, IIID, IIP	PAN 4420/4450I	PAN 4450	Epson 6000, Action, Tosh. Page Laser 6	DKI 400
1Meg	85.00	89.00	105.00	169.00	119.00
2Meg	115.00	125.00	155.00	—	179.00
4Meg	195.00	199.00	260.00	—	279.00

Other Laser Memory Available: QMS, TI, Konica, NEC

IBM LASER PRINTER, Model 4019

1Meg: 1039136 \$99 2Meg: 1039137 \$145
3.5Meg: 1038675 \$229

H.P. COMPATIBLE FONT CARTRIDGE

Turbo 25 contains every English language font in Pacific Data's current 25 CARTRIDGES IN ONE!™ Cartridge, plus 2 Headline Fonts with 6 additional U.S. Fonts — Made by UDP Data Products 119.00
Turboscript™ gives you 47 scalable fonts in any point size. 12 more than Pacific Data or HP Adobe Postscript, supports the very latest Adobe Type 1 Font Formats — Made by UDP Data Products 249.00

NO SURCHARGE FOR MASTERCARD, VISA OR DISCOVER. PURCHASE ORDERS ACCEPTED FROM FORTUNE 2000, GOVERNMENT & INSTITUTIONS. Price & availability subject to change. California orders add 7% sales tax. Returned orders or ordered wrong parts are subject to a 20% restocking fee. (Memory chips not installed in boards.) We accept International orders shipped via UPS Air, APO, FPO orders welcome. All credit card charges verified for fraudulent use. **SORRY NO REFUNDS AFTER 30 DAYS — EXCHANGES ONLY.** We accept MC, VISA, Discover, AE, prepaid orders, purchase orders, wire transfer, COD (cashiers check) orders, cash & cashiers checks

EVEREX

EV-3000, EV-159
0-3Meg, 4.0 Lim compatible • Uses 256x1 chips \$99.00
EV-8000, EV-178
0-8Meg, 4.0 Lim compatible • Uses 1Megx1 chips • Supports multi-tasking & DMA multi-tasking in hardware \$219.00

ORCHID RAM QUEST 16/32

0-8Meg of Backfill, Expanded or Extended Memory Works with P/S2 Models 50, 50Z, 55SX, 60, 70, 80 Full Support for LIM/EMS 4.0 and OS/2 — 0 Wait State Ram 4 Year War. — Comes w/Ser, Par

Paradise

ORDER TOLL FREE: U.S. & Canada - 1 800 348-4PCP (4727)

Japan - 0031-11-1865

In Hawaii
(808) 875-1100

Australia - 0014-800-126-943

FAX - 1 (808) 875-0061

Shipping & Technical Assistance - 1 (808) 875-1108

Quality at the best prices under the sun.



Specializing in International Orders

COMPUTERS

IBM PS/2	
Laptop	Call
PS/2 Mod 30-286 30 Mb	1425
PS/2 Mod 50Z 30Mb/60 Mb	1250/1500
PS/2 Mod 55SX 30/60 Mb	1950/2100
PS/2 Mod 65SX 60/120 Mb	3550/3725
PS/2 Mod 70 60/120/A21	2915/3786/4800
PS/2 Mod 80 80/160/320	3275/3625/5075
PS/2 Mod 90/95-486	Call
PS/2 Mod 75	Call

COMPAQ	
LTE 286 20/40 Mb	2200/2300
LTE 386 SX 30/60	3695/3995
SLT 386 60/120 Mb	4299/4750
DPro 386S 20 Mod 1/40 Mb	1655/2150
DPro 386E 40/110 Mb	2750/3033
DPro 386/25E (All Models)	Call
DPro 386/33L 120 Mb	5099

TEXAS INSTRUMENTS	
TI Travelmate 2000/3000	Call

AST	
Executive 286/386	2125/2850
Premium 286 512k	1047
Premium 386 16/25/33	Call
Premium 486	Call

TOSHIBA	
T1000 SE/XE/LE	956/1259/1459
T1200 XE 20/40 Mb	1850/2099
T2000 SX 40 Mb	2999
T3100 SX 40/80 Mb	2996/3239
T3200 SX 40/120 Mb	3239/3550
T3200 SX Color	5799
T5200 40/100/200/Color	4488/4199/4688/5924

DFI	
286-12 Mhz	539
386-16 Mhz	839
386 SX-20 Mhz	965
386-25 Mhz	1215
386-33 Mhz	1590
486-25 Mhz	3039
1-year on-site warranty	Call for Custom Configurations

PANASONIC	
170/270	1439/1939

MONITORS & TERMINALS

MONO/COLOR	
IBM 8503/8512	227/459
Samsung RGB	200
Amber 12" TTL	85

VGA EGA MONITORS	
IBM 8506/07/08	899/629/928
IBM 8513/14/15	525/1150/699
Magnavox VGA	259
Mitsubishi EGA	329
Mitsubishi 1381/HL 6935	485/1900
NEC 2A/3D	460/595

NEC 4D/5D	969/2265
Packard Bell 8529/8541/8510	275/290/339
Panasonic 1381/1391	429/499
Samsung VGA/4581/4592	344/430/309
Sony CPD 1304	660
Zenith 1492	595

VIDEO BOARDS

ATI VGA/Ultra	Call
ATI VGA Wonder 256/512+	199/240
Everex EGA	89
Hercules GB 1024/1024+2	659/959
NEC Graphics Engine 256	895
Orchid ProDesigner II 1 Mb	319
Paradise VGA/+16	122/145
Paradise VGA 1024	175/219
Herc/Mono/w Parallel Card	45
VGA 1024 256/512	109/139

PRINTERS

CANON	
BJ10E	309
CITIZEN	
120D/GSX140/GSX145	135/295/399
HSP500/550	301/421
DICONIX 150	
P/S	343/347
EPSON	
LX 810	173
FX 850	289
FX 1050	399
LQ 510	259
LQ 850	435
LQ 860	549
LQ 1010	369
LQ 1050	579
LQ 2550	849
EPL 7000	Call
EPL 7500	Call

HEWLETT-PACKARD	
LaserJet 3/3D	1589/2499
LaserJet 3SI	3750
LaserJet 2P/3P	859/1075
DeskJet 500	489
ScanJet+	1069
PaintJet/XL	955/1680

FONTS & MEMORY	
Pacific Data 25-1	259
Pacific Data 1/2/4 Mb	129/159/265
Pacific Connect Laser Share	299
Pacific Page PE/XL	349/699
Pacific Data Plotter in a Ctg	239
LaserJet Memory 1/2/4 Mb	119/149/245
Compaq 1/4 Mb Modules	118/383
IBM/Toshiba Memory	Call
CPI Jet Page/Superset 425+	299/259

IBM	
4019 E/4019 Laser	1026/1595
Proprinter XL24E/X24E	765/595
Proprinter P	365

ExecJet	780
NEC	
P-3200/3300	276/Call
6200/6300	476/645
Silent Writer 290	2450
Silent Writer 2 Mod 90	1595

OKIDATA	
ML 182	228
ML 320/321	324/451
ML 380	289
ML 390+/391+	449/613
ML 393+/393+color	968/1055
Okilaser 400/800	639/965
Okilaser 820/840	1276/1949

PANASONIC	
1123/1180	239/165
1124/1124i	269/329
1624/1654/1695	379/619/410
4420/4450/4455	869/1244/2099

TERMINALS

Wyse 50/60	375/300
Wyse 30/85	310/339
Wyse 150/185	289/379

SOFTWARE

Aldus Pagemaker 4.0	495
Ashton Tate dBase III+/IV	419/479
Borland Quattro Pro.2.0	295
Carbon Copy	105
Clarion Prof. Developer	450
Compaq/IBM DOS	Call
Harvard Graphics 2.3	289
IBM Displaywrite 5.0	249
Lotus 1-2-3 2.2/3.1	349/399
Microsoft	All Titles-Lowest Price
Microsoft Windows 3.0	93
Norton Adv. Util 5.0	110
Procomm Plus	62
Quicken 4.0	39
Ventura Publisher V 3.0	479
WordPerfect 5.1	245
400 Additional Titles In Stock	

PLOTTERS AND DIGITIZERS

HEWLETT-PACKARD	
7475A	1349
7570A/7575A	2699/3500
7576EXL	4599

SUMMAGRAPHICS	
Summasketch 2 12X12/12X18	335/565

CALCOMP	
Pacesetter 2000	3150/3995
12 X 12, 12 X 18	298/597

MULTIFUNCTION BOARDS, CARDS, CHIPS

IBM 5250 Emulation	675
AST 5251 Emulation	499
AST 6-Pack w 384 k	145
Intel AboveBoard Plus w/512 k	289
Intel InBoard 386 PC	492

Cyrix Fasmath	Call
80287-XL	189
80387-SX/16/20/25/33	290/320/378/462/562

MODEMS & COMMUNICATIONS

ATI 9600 ETC	484
CPI 2400 Internal	79
CPI 2400 Ext Fax	123
CPI 2400 Ext MNP	154
CPI 9600 Ext	439
Everex 2400i/2400 MNP	99/164
Hayes 2400/2400B	319/218
Hayes Ultra 96	639
Practical Pocket Modem	99
Intel 2400/9600	217/499
MegaHertz Laptop Modems	Call
Practical Perif. 2400/9600	132/479
US Robotics HST/Dual	585/809

FAX MACHINES

Sharp FO 216/240/334	559/699/795
Intel Satisfaction	385
JT Fax 9600 B	339
CPI 2496 IF	173

MICE

DFI 200/400	32/42
Logitech C9/Bus/PS2	82
Logitech Mouseman	72
Logitech ScanmanPC/PS2	169/240
Microsoft Mice/+Windows 3.0	103/145

DRIVES & TAPES

Colorado DJ10	239
Conner 40/100	299/499
ST 225/238	189/192
ST 157A/251-1	229/239
ST 1126A/1144A/1239A	449/630/795
ST 4096/4182E	530/925
Plus II XL 50/105	388/578
Mountain	Call
Panasonic LF5010 Worm	2215
Procom Ext 5.25 PS/2	199
Procom Ext PS2 Hard Drives	Call
Procom Laptop Floppy	Call

NETWORK

Call us For The Best Prices Anywhere	
MISCELLANEOUS & ACCESSORIES	
Keytronics KB101+	89
Kensington Masterpiece Plus	85/95
AB Switch Box	27
TrippLite 450/1200, 2000	296/618/1175
4 outlet surge	39

Win
A Free
Hawaii Vacation!

Ask for details.

No purchase necessary

Most orders shipped insured next or second day air **FEDERAL EXPRESS** / 24-hour worldwide order tracking / Printer Orders received by 9 PM CST can be shipped same day / All credit card and COD orders checked electronically / We accept Amex, Visa, MC, JCB, Discover, Diners Club, COD's, Wire Transfer, Letter of Credit, **TERMS & LEASE AVAILABLE** (one day approval) / Credit cards not charged until product shipped **GOVERNMENT AND EDUCATIONAL P.O.'S ARE WELCOME** / Allow 10 days for personal checks to clear / Prices reflect a 3 per cent cash discount / Non-defective returns subject to a restocking charge / All warranties good through Paradise Computer Products / Prices subject to change without notice.

HOURS: 8:30 AM TO 8:30 PM CST MON-FRI, 10 AM TO 4 PM CST, SAT.
Paradise Computer Products Ltd. P.O. Box 890553 Dallas, TX 75389-0553

Circle 220 on reader service card



ORDER 1-800
Toll-Free
688-6468



MINUTEMAN COMPUTERS

90 Day Money
Back Guarantee
2 Year Parts/Labor

286-12/16 MHz

- 1MB RAM
- AMI bios w/ setup
- 1.2MB 5.25" drive
- 1.44MB 3.5" drive
- 42MB hard drive
- 16 bit VGA card
- 14" VGA color monitor
- 2 ser, 1 par, 1 game port
- MS-DOS 3.30 or 4.01

12MHz \$ **995**
16MHz **1,105**



386-25e MHz

- 4MB RAM - 64KB cache
- AMI bios w/ setup
- 1.2MB 5.25" drive
- 1.44MB 3.5" drive
- 125MB 19ms hard drive
- 16 bit VGA card w/ 512KB
- 14" Super VGA color monitor
- 2 ser, 1 par, 1 game port
- MS-DOS 3.30 or 4.01

\$ 2,095

386-16sx MHz

- 1MB RAM
- AMI bios w/ setup
- 1.2MB 5.25" drive
- 1.44MB 3.5" drive
- 42MB hard drive
- 16 bit VGA card
- 14" VGA color monitor
- 2 ser, 1 par, 1 game port
- MS-DOS 3.30 or 4.01

\$ 1,425

386-25 MHz

- 1MB RAM
- AMI bios w/ setup
- 1.2MB 5.25" drive
- 1.44MB 3.5" drive
- 80MB hard drive
- 16 bit VGA card
- 14" VGA color monitor
- 2 ser, 1 par, 1 game port
- MS-DOS 3.30 or 4.01

\$ 1,799

386-33 MHz

- 4MB RAM - 64KB cache
- AMI bios w/ setup
- 1.2MB 5.25" drive
- 1.44MB 3.5" drive
- 125MB 19ms hard drive
- 16 bit VGA card w/ 512KB
- 14" Super VGA color monitor
- 2 ser, 1 par, 1 game port
- MS-DOS 3.30 or 4.01

\$ 2,325

Drives

SEAGATE

MODEL	MB	SPEED	TYPE	
ST238	30MB		MFM	CALL
ST251-1	40MB	28ms	MFM	CALL
ST157A	40MB	28ms	IDE	\$ 210
ST1102A	89MB	19ms	IDE	330
ST1126A	111MB	25ms	IDE	599
ST1144A	125MB	20ms	IDE	435
ST1162A	143MB	15ms	IDE	670
ST1239A	210MB	15ms	IDE	CALL
ST2383A	338MB	16ms	IDE	CALL

CONNER

MODEL	MB	SPEED	TYPE	
CP3044	40MB	25ms	IDE	CALL
CP3184	80MB	28ms	IDE	CALL
CP3104	100MB	25ms	IDE	CALL
CP3204	200MB	19ms	IDE	CALL

MAXTOR

XT 7040A				\$ 235
XT 7040A				350

We also carry Micropolis and much more.

TEAC

360K 5.25"				\$ 59
720K 3.5" Kit				65
1.2MB 5.25"				70
1.44MB 3.5" Kit				70

Disk Controllers

WESTERN DIGITAL

IDE/MFM/RLL		CALL
-------------	--	------

Floppy controllers also available.

486-25 MHz

- 4MB RAM - 128KB cache
- Choice of cases
- 1.2MB 5.25" drive
- 1.44MB 3.5" drive
- 200MB 16ms hard drive
- 16 bit VGA card w/ 512KB
- 14" Super VGA color monitor
- 2 ser, 1 par, 1 game port
- MS-DOS 3.30 or 4.01

\$ 3,825

Monitors

NEC

Multisync 2A	\$ 465
Multisync 3D	582
Multisync 4D	994
Multisync 5D	2275

SONY

1302	CALL
1304	CALL

AAMAZING

12" Amber	\$ 78
VGA 39	284
VGA 28	302

Printers

HEWLETT PACKARD

Laser Series III	CALL
Laser IIIP	Too low to advertise
Laser III D	CALL
Laser II P	CALL
Laser III SI	CALL
Desk Jet 500	CALL

All accessories available.

PANASONIC

1124/1180	CALL
1191	CALL
1624/1695	CALL
4420	CALL
4450i/4455	CALL

EPSON

LQ 810	200 cps, 30 nlq	\$ 175
FX 850	264 cps, 54 nlq	289
FX 1050	264 cps, 54 nlq	398
LQ 510	225 cps, 75 nlq	259
LQ 850	330 cps, 88 nlq	440
LQ 950	330 cps, 88 nlq	439
LQ 1010	225 cps, 75 nlq	369
LQ 2550	400 cps, 108 nlq	855

OKIDATA

ML320	\$ 319
ML321	435
ML390	445
ML380	289

We also carry mice, modems, scanners, memory, laptops, and much more in stock.

All system accessories carried individually by Minuteman. Call us with your needs first!

We accept VISA, Mastercard,
COD on purchase orders.
Dealer accounts welcome.

No surcharge on
VISA/Mastercard.

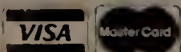

At Minuteman Computers, we offer a knowledgeable
sales staff, expert technical support, and prompt delivery!

1-800-688-6468

Circle 176 on reader service card

Hours M-F 8:00-5:00
(714) 646-9814

Fax (714) 646-9877

887 19TH ST, UNIT #C
COSTA MESA, CA 92627



If You're Not Buying From Bulldog — You're Barking Up The Wrong Tree!

SOFTWARE

Aldus PageMaker	495
Carbon Copy	110
Clarion ProDeveloper	449
Clipper 5.0	499
Corel Draw	385
Dbase IV	489
Enable O/A	415
Finesse V3.1	110
Foxbase	195
Freelance Plus	325
Framework III	455
Harvard Graphics	309
IBM DisplayWrite V	229
Lotus 2.01/2.2/3.1	309/345/399
Lotus Symphony	489
Manager's Organizer	149
Microsoft Word	219
Microsoft Word for Windows	319
Microsoft Excel for Windows	319
Multimate 4.0	249
Peachtree III Complete	139
Paradox V3.5	489
Procom Plus	64
Q & A 4.0	269
Quatro Pro	315
Rbase V3.1	485
Super Calc V	299
Ventura Desktop Publ.	529
Word Perfect 5.1	239
WordStar 5.5/6.0	169
WordStar 2000 +	229
WordStar Legacy	229
WordStar Laptop	132
Peachtree Double Bonus	219
Microsoft Windows 3.0	109

Lots of other software available and all the prices are byte size!

PRINTERS

EPSON	
LX 810	\$159
FX 850/FX 1050	289/389
LQ 200/LQ 510	229/249
LQ 850/LQ 1010	435/359
LQ 1050/LQ 2550	569/849
EPL 7000/EPL 7500	799/1999
LQ 860	549
Epson ES300C Color Scanner w/ES300 Dos Interface	1450
DICONIX	
Diconix 150+	345
SEIKO	
Smart Label	189
OKIDATA	
172/182 Turbo	199/229
320/321	319/449
380	235
390 Plus/391 Plus	449/605
393 Plus/393 Color Plus	955/1069
OKI LASER	
840/820	2039/1359
800/400	1020/655
TOSHIBA	
Express 420/Express 440	319/449
NEC	
P3200/P3300	295/419
P9300	969
2000 XE	249
6200/6300	479/639
Silent Writer II-90	1659
PANASONIC	
1124/1124i/1180	249/289/149
1123/1654	229/519
1624/1695	359/365
4420	CALL!
4450i/4455	1119/1999
HEWLETT-PACKARD	
Laser Series III	1599
Laser III D	2599
Laser II P	899
Laser III P	Call
Desk Jet 500	525
LASER ACCESSORIES	
Pacific Data 1mb/2mb	109/149
Pacific Data 25-N-1	259
Pacific Bar Code	315
Pacific Outlines	187
Pacific Page PE/Pacific Page XL	339/749
Pacific Type/Pacific Print	259/219
Plotter in a Cartridge	229
Headlines in a Cartridge	199
Pacific Connect 256K	249
Complete Font Library	249
Super Set Plus 425	265
CANON	
LB P4	955
LBP 8 III	1799
BJ 10E	339

VIDEO CARDS

ATI	
VGA Wonder Plus 256K/512K	209/259
Ultra 8514 512K/1MB	399/539
Ultra 8514 + VGA 512K/1MB	469/599
CARDINAL	
VGA 116/VGA 600	79/119
VGA 700/732 w/1MB	149/179
DFI	
Mono Card/Color Card	39/39
GENOA	
Genoa 6300/Genoa 6400	199/239
HERCULES	
Graphics Card	179
In Color Card	145
VGA Card	119
NEC Graphics Engine w/1MB	899
ORCHID	
Pro Designer II 512K/1MB	279/329
Pro Designer/E	189
PARADISE	
VGA Plus 8/16	135/169
1024 256K/512K	199/229
VIDEO-7	
Vega VGA	139
1024i 256K/512K	199/229
VRAM II 512K/1MB	349/419

BULLDOG SYSTEMS

286-12	\$839
386-SX/16	1019
386-25	1439
386-25C W/4 MEGS	1715
486-25C W/4 MEGS	2485

STANDARD CONFIGURATION:
1MG, 1.2 FLOPPY, 40 MG HD, VGA CARD, DOS, PARA/SERIAL PORT, KEYBOARD

80 MEG ADD 75
VGA MONITOR ADD 299
SUPER VGA W/1MB & MONITOR ADD 399

CALL FOR OTHER CONFIGURATIONS!!

FREE shipping on all **BULLDOG** systems prepaid with a Cashiers Check, Money Order or Bank Wire!

LEADING EDGE SYSTEMS

D3/SX — 80386SX/16 MHZ, 1 mg Ram, 1.2, 52 mg hard drive, VGA video controller	1349
D2/LPS — 80286/12 MHZ, 1 mg Ram, 1.44, 40 mg hard drive, VGA on motherboard	869

AST SYSTEMS

AST Premium 286 Model 70	1075
AST Premium 386 Model 300C	2879

MAGNAVGA SYSTEMS

286/12 — 1 meg, 3 1/2" 1.44, 5 1/4" 1.2, 40 mg hard drive, VGA card, dos	895
386/SX — 1 meg, 3 1/2" 1.44, 5 1/4" 1.2, 80 mg hard drive, VGA card, dos, bundled w/Lotus Works, Publish It! and System Utilities	1325

LAPTOPS

You can take these lightly!

Leading Edge DLT/386 Plus — 80386SX—16 MHZ, 2 mg Ram, 1.44, 40 mg hard drive, Supertwist LCD screen	1749
Panasonic CF170 Notebook	1449
Panasonic CF270 Notebook	1795
Atari Portfolio Palmtop	239

Call for Pricing on Toshiba Laptops!

MICE & MISC

Keycat II - 101 Keyboard w/Trackball	89
Microsoft Mouse w/windows 3.0	159
Microsoft Mouse w/PC Paintbrush	109
Mousesystems Mouse	89
Logitech Scan Man/Scan Man 256	179/295
Logitech Mouse Man Serial/Bus	69/79
Logitech Track Man Serial/Bus	79/85
Summasketch 12x12/12x18	339/579
The Wave Keyboard	59
Marstek 105 w/Paintbrush and OCR	169
Marstek 800 w/Paintbrush and OCR	209
Marstek 800 for Windows	229
Marstek Color Artist	499
Epson ES 300 C Color Scanner	1450
PC Mouse III	79
White Mouse Serial/Bus	55/65
Omni Mouse II Serial/Bus	39/55
PC Trackball Serial/Bus	49/65
MSC Color Hand Scanner	535
Dest Personal Scanner	695
Sun Moon Star CD Rom	819

MODEMS & FAX

ADTECH MICRO SYSTEMS	
Datafax 2400 Modem/9600 Fax	185
Externally Yours Modem/Fax	198
Smart Connect 2400 INT w/MNP5	65
Perfect Fax 96 Fax Card	105
Teleshare Fax/Modem Switch	105
CARDINAL	
2400 Int/Ext	79/99
2400 Int/Ext w/MNP	129/139
2400 Int w/Sendfax	110
9600 Int	399
EPSON	
Epson Priority Fax 3000	575
EVEREX	
1200 Int	69
2400 Int/Ext	85/169
2400 Int/Ext w/MNP	169/199
2400 Int PS/2	179
24/96 Fax Modem Int/Ext	235/319
HAYES	
2400 Int/Ext	169/329
9600 Int/Ext	525/659
Megahertz Laptop Modems	125
PRACTICAL PERIPHERALS	
2400 Int/Ext	129/179
9600SA Ext	475
2400 Pocket Modem	109
TOSHIBA FAX MACHINES	
3450/3750	659/729
4400	555

TAPE DRIVES

ARCHIVE	
40Meg Int/Ext	249/409
60Meg w/Cont Int/Ext	589/589
COLORADO MEMORY SYSTEMS	
DJ10 120Meg Int Jumbo	259
DJ20 250Meg Int Jumbo	319
Dual Floppy Cable CK-17	25
External Kit KE-10	115
EVEREX	
60F Int	245
60Meg Teac w/Card Int/Ext	595/699

NETWORK

Call for the best pricing on all your networking needs!

3 COM	
3C503 Etherlink II	195
3C503 Five Pack	789
3C507 Etherlink 16	279
ARTISOFT (LANASTIC)	
Starter Kit 10MBS/2MBS	479/349
Lan Cards 10MBS/2MBS	209/145
PS/2 Lan Cards 10MBS/2MBS	269/205
HAYES	
Lan Step Base System (5 User)	349
Lan 5 User Expander	229
NOVELL	
Netware 2.2 5/10 User	649/1419
Netware 3.11 20/100 User	2459/4839
Ethernet NE1000/NE2000	155/189
SMC	
PC130/PC130E	99/129
PC500WS/PC500FS	235/305
HUB 8-Active/4-Passive	289/79
THOMAS CONRAD	
TC6142/TC6142-TP+	85/105
TC6245/TC6245-TP+	205/219
TC6045/TC6045-TP+	199/219
WESTERN DIGITAL	
Ethercard 8 Bit/16 Bit	159/179
Token Card 8 Bit/16 Bit	349/399
10 Base-T Card 8 Bit/16 Bit	185/215

OTHER NETWORK PRODUCTS CALL!

HARD & FLOPPY DRIVES

CONNER	
40 IDE 3.5"/104 IDE 3.5"	239/419
120 IDE 3.5"/100 IDE 3.5"	459/670
IOMEGA	
Bernoulli 20 Meg Int/Ext	825/1110
Bernoulli Dual 20 Meg Ext	1789
Bernoulli 44 Meg Int/Ext	819/919
Bernoulli Dual 44 Meg Ext	2045
PC2B Bootable Controller	189
MAXTOR	
40 Meg AT IDE/80 Meg AT IDE	205/339
PACIFIC RIM	
Ext Drive PS/2	179
Ext Drive 360/1.2	199
Ext Drive Most Laptops	209
PLUS DEVELOPMENT	
Hard Card 20/40 for XT	489/549
Hard Card II 80 for AT	595
Hard Card XL 50/105 for AT	389/675
WESTERN DIGITAL	
40 Meg IDE	229
SEAGATE	
ST225/ST238 Kit XT	239/249
ST251-1/ST4096 AT MFM	249/469
ST280A/ST1239A AT IDE	289/799
TOSHIBA FLOPPY	
360K/1.2MG/1.44MG	65/75/75

MEMORY BOARDS

AST	
Six Pack+ w/384K XT	145
Six Pack 286 w/OK AT	109
Rampage 286 w/OK AT	319
INTEL	
Above Board+ w/512K XT/AT	345
Above Board II+ w/OK PS/2	299
Above Board +8 w/2Mgs AT	499
ORCHID	
Ramquest 16/32 w/OK PS/2	219
Ramquest 8/16 w/OK XT/AT	129
EMULATION BOARDS	
AST 5251-11 Enhanced Plus	499
DCA Irma Board III	415
DCA E78+ Software	279
ACCELERATOR BOARDS	
Orchid Tiny Turbo 286	205
Orchid Tiny Turbo Extra	249
Orchid Tiny Turbo AT	359
Intel Inboard 386PC w/1Mg	499
DISK COMPRESSOR	
Infoclip Expanz	139
Stac Electronic Stacker	145

MATH CO-PROCESSORS

INTEL	
8087-3	79
8087-2	129
387-16	319
387-20	405
INTEL 387-25	505
387-33	579
387-SX	319
287-XL/XLT	205
CYRIX	
387-16/20	275/289
287XL	149
387-25	379
387-33	469
387-SX16	219
387-SX20	245
1mb Simm 80NS	59
256K Simm 80NS	19
Simm, Dram and Sipp	Call
ULSI	
387SX-16/20/25	235/259/299
387-25	359
387-33	419

MONITORS

Get The Picture!

NEC	
MULTISYNC	
2A	499
3D	659
4D	989
5D	2350
PANASONIC	
1381/1391	339/499
SAMSUNG	
Flat White ML 4571	135
14" VGA Color CVJ 4891	335
MAGNAVOX	
9CM082	335
LEADING EDGE	
.31 VGA Color	309
CTX	
.28 Super VGA Color (#5468)	359
1024 x 768	

All prices are cash prices! Retail outlet may have slightly higher prices.

SALES HOT LINE
1.800.438.6039

110 Industrial Park Drive
Greensboro, NC 27409

Hours: Monday thru Friday 9:30 a.m. to 7:30 p.m.
Saturday 9:00 a.m. to 6:00 p.m.

MasterCard American Express VISA DISCOVER TeleCheck PROXIOS

PC Magazine says "... Arlington offers worry-free mail order purchasing at reasonable rates!"

HEWLETT-PACKARD

Laserjet III w/Toner	\$1549
Laserjet IIP w/Toner	\$869
Laserjet IIIP w/Toner	\$1069
1MG Upgrade	\$99
2MG Upgrade	\$139
4MG Upgrade	\$229
Deskjet 500	\$499
Pacific Page/XL	\$329/\$699
Pacific CFL	\$259
Pacific Data 25 in 1 Font ..	\$249

EPSON PRINTERS

LX810	\$155	LQ510 ...	\$245	LQ1050 ..	\$569
FX850	\$289	LQ850 ...	\$435	LQ2550 ..	\$849
FX1050 ...	\$395	LQ860 ...	\$549	EPL7000 ..	\$789
LQ200 ...	\$229	LQ1010 ..	\$359	EPL7500 ..	\$1979

OKIDATA PRINTERS

ML320 ...	\$319	ML390 ...	\$439	OLC 400 ..	\$639
ML321 ...	\$439	ML391 ...	\$599	OLC 800 ..	\$949
ML380 ...	\$219	ML393 ...	\$919	OLC 820 ..	\$1249

PANASONIC

1123	\$219	1654	\$539
1124I	\$275	1695	\$369
1180	\$149	4420	\$799
1191	\$219	4450I ...	\$1089
1624	\$349	4455	\$1999
4420/4450I 2MG Memory ..	\$179		

CITIZEN

GSX140 ..	\$279	GSX200 ..	\$159
GSX145 ..	\$399	HSP500 ..	\$299

ARLINGTON COMPUTERS

386 SX-16, 1MG, 40 MG,
VGA Mono Monitor **\$999**

386-25, 2MG, 1.2 Floppy, 40 MG,
VGA Mono Monitor **\$1299**

386-33W/64K Cache, 4MG, 89 MG,
VGA Mono Monitor **\$1699**

NOTEBOOKS

AST 43V, 386, 40 MG ..	\$2799
Epson NB3S, 40 MG ...	\$2999
Panasonic CF170, 10 MHz, 20MB	CALL
Panasonic CF270, 16 MHz, 20MG, VGA ...	CALL

GOLDSTAR

286, 12 MHz, 1 MG Memory, 40MG, VGA Monitor	\$949
386SX, 16 MHz, 1MG, 40MG, VGA Monitor	\$1099
386SX, 20 MHz, 1MG, 40MG, VGA Monitor	\$1249
386 Tower, 33 MHz, 4 MG Memory	\$1799
Laptop - 386SX, 40 MG, VGA	\$1799

IBM PS II

Model 30, 286, 40 MB, w/Monitor	\$1699
Model 55SX, w/60 MB w/Monitor	\$2149
Model 70, (20 MHz), w/60 MB and Monitor ..	\$3049
Model 70, w/121 MB and Monitor	\$3399
Model 70-A21, w/121 MB and Monitor	\$4699
6 Month Warranty	

COMPAQ

Model 386S w/40 MB ..	\$1999
Model 386E w/40 MB ..	\$2599
Model 386E w/100 MB ..	\$2799
Model 386 25E w/100 MB	\$3749
386-33L, w/120 MB	\$5199
LTE 20	\$1699
LTE 286 20/40 ...	\$2099/\$2449
LTE 386-60MB	\$3999
6 Month Warranty	

MULTIFUNCTION BOARDS

AST 6 Pack w/384K	\$159
AST 6 Pack 286	\$189
AST Rampage Plus	\$329
Irma Board III	\$399
AST 5251-II Plus	\$459

intel

Intel Above Board+	\$289
Intel Plus 8 w/2 MG	\$429
Intel 386 PC w/1 MG	\$459
Intel Satisfaxtion	\$369
Intel Snap-In 386	\$369

SCAN. & DIGIT.

Panasonic FXRS 3070U ..	\$939
Summasketch 12x12	\$319
Summasketch 12x18	\$559
Panafax PD-2300	\$539

DRIVES & TAPES

Ext. 5 1/4" for PSII	\$159
Ext. 1.2 for PSII	\$169
Toshiba 3 1/2" 720K	\$69
Toshiba 3 1/2" 1.44	\$69
Colorado Jumbo 120	\$259
Everex 40 MB Tape	\$239
Everex 60 MB Tape	\$599

SEAGATE HARD DISKS

48 MB 3 1/2" (157N-Kit)	\$279
40 MB (157A)	\$189
40 MB for AT (ST251-1) ..	\$239
80 MB for AT (4096)	\$479
80 MG 296 Kit	\$369
89 MG 1102A	\$299
211 MG 1239	\$699

IOMEGA

20 MB Int. w/boot card ..	\$999
44 MB Int. w/boot card ..	\$1125

PLUS

Hard Card 40 MB	\$549
Hard Card 50 XL	\$379
Hard Card 80 MB	\$489
Hard Card 105 MB	\$569

CONNOR HARD DRIVES

40 MB	\$229
100 MB/200MB	\$409/\$659

MODEMS

Hayes 1200/2400 Ext	\$279/329
V-Series 9600 Int.	\$499
Hayes Ultra 96	\$639
Intel 2400	\$139
Intel 2400 Ext.	\$159
Intel 2400 Ext. MNP	\$209
Intel 9600	\$479
Megahertz 2400 Toshiba	\$129
2400 Cpq LTE	\$129
Everex 2400	\$89
Everex 2400 External	\$169
US Robotics 9600	\$579

CHIPS

256K/1 MG Chips . each	\$4/\$7
256K/1MB Simms	\$30/\$59
Compaq 386 1 MB	\$99
Compaq 386 4 MB	\$299
Compaq 386 2 MB-33 ...	\$179
Compaq SLT 2 MB	\$249
Compaq LTE 2MB	\$179
Compaq LTE 386 4MB ..	\$499
Compaq Port 2MB	\$275
IBM 2-8 MG Board	\$379
IBM 30-286 512K	\$69
IBM 70 & 80 2 MB	\$149
Toshiba Port 2MB	\$169

intel

Intel 8087-3	\$89
Intel 8087-2	\$109
80287-10XL	\$179
80287 XLT	\$189
80387-16/80387-SX ..	\$309/\$279
80387 SX-20	\$299
80387-20	\$349
80387-25/80387-33 ..	\$439/\$539
80487 SX	\$449

NETWORKING

Advanced Network 2.15	\$2099
SFT Network 2.15	\$2899
ELS Level I 4 User	\$489
NE1000 Ethernet	\$149
NE2000	\$179
Ethercard +/+16	\$139/\$169
EtherLink II 3 Com	\$189

SOFTWARE

D Base IV	\$479
Harvard Graphics	\$299
Lotus 123 2.2/3.1 ..	\$329/\$349
Microsoft Mouse	\$99
Microsoft Excel	\$299
Microsoft Windows 3.0 ..	\$99
Microsoft Word	\$219
Multimate Version IV	\$239
R Base for DOS	\$439
Symphony	\$459
Ventura Desktop Publ. ..	\$519
Word Perfect 5.1	\$249

VIDEO BOARDS

ATI 16 Basic	\$89
ATI VGA Wonder	\$189
ATI VGA Wonder 512 ...	\$209
Epson VGA 16 Bit	\$79
Goldstar VGA	\$69
Genoa 6300/6400 ..	\$169/\$219
Hercules Station	\$649
NEC Grph Engine 256 ..	\$899
Orchid Pro II	\$279
Paradise VGA	\$139
Paradise +16	\$179
Paradise VGA 1024	\$149
STB Power IMG	\$199

MONITORS

MITSUBISHI

EGA	\$329
Diamond Scan	\$489
HL6615 16"	\$1029
HL6935 20"	\$1789
3950 ADK	\$1649

NEC

Multisync IIA	\$449
Multisync IIID	\$599
Multisync IVD	\$979
Multisync VD	\$2199

PANASONIC

1381 VGA 1024x768	\$329
1391 VGA 1024x768	\$499

GOLDSTAR

Color/EGA	\$199/\$269
VGA 1425+/1430 ...	\$279/\$299
VGA 1460	\$329

Defective software will be replaced with the same item only. We cannot guarantee compatibility. Returned shipments are subject to a restocking fee. Prices and availability subject to change without notice.

HOURS C.S.T.
7:30 - 6:30 pm - Mon.-Fri.
9:00 - 1:00 pm - Saturday

1970 CARBOY
MT. PROSPECT, IL 60056

FOR ORDERS & SYSTEMS QUOTES: **800-548-5105**

CUSTOMER SERVICE AND IN ILLINOIS 708-228-6333

SHIPPING 708-228-9748

TECHNICAL ASSISTANCE 708-228-1470

We Export! FAX 708-228-0516

No surcharge for MasterCard or Visa.

**Arlington
Computer
Products, inc.**

Cards in reader service card



"Dave sez... all ACP drives include no-hassle 30-Day Guarantee* and 1-Year Replacement policy.**"

Hard Drives!



the Hard Drive King!

KLÖK Hard Drives

Model	Size and description	AT Kit	Bare
KL320	21.4 Mb, 40ms, 3.5", HH, MFM	\$ Call.	\$ 149.
KL330	30 Mb, 40m, RLL, HH	Call.	169.
KL343	42.57 Mb, 30ms, 3.5" AT, Embedded	259.	219.

...specify Gray or Black Faceplates for 5-1/4" installation kits

Western Digital

w/AT Kit Bare
40Mb....\$249. \$209.
 WD93044A, 28ms, IDE
80Mb....\$389. \$349.
 WDAC280, 17ms, IDE

CONNER

AT Embedded Hard Drives

CP2024	21.4Mb, 23ms	\$ 399.
CP3000	42.8Mb, 28ms	239.
CP3184	84Mb, 25ms	459.
CP30104	120Mb, 18ms	549.
CP3104	104.9Mb, 25ms	449.
CP3204	209.7Mb, 19ms	799.

SCSI Hard Drives

CP3040	42.8Mb, 25ms, 1"	..	\$ 289.
CP3100	104.9Mb, 25ms	489.
CP3200	209.7Mb, 19ms	849.

...call for controllers and adaptors

MICROPOLIS ESDI/SCSI Drives

Model	Size and description	PC PAK	Bare
MC1355	159 Mb, 23ms, ESDI, 5-1/4", FH\$ 562.	\$ 478.
MC1654-7D	161 Mb, 16ms, ESDI, 5-1/4", HH 935.	799.
MC1558-15	338 Mb, 18ms, ESDI, 5-1/4", FH 1414.	1254.
MC1664-7	345 Mb, ESDI, 5-1/4", HH 1395.	1275.
MC1568-15	676 Mb, 16ms, ESDI, 5-1/4", FH 1995.	1875.
MC1375	153 Mb, 23ms, SCSI, 5-1/4", FH 562.	478.
MC1674-7D	158 Mb, 23ms, SCSI, 5-1/4", FH Call.	975.
MC1578-15	332 Mb, 18ms, SCSI, 5-1/4", FH 1472.	1268.
MC1684-7	345 Mb, 14ms, SCSI, 5-1/4", FH 1395.	1275.
MC1588-15D	668 Mb, 16ms, SCSI, 5-1/4", FH 1995.	1875.
MC1598-15	1049 Mb, 14ms, SCSI, 5-1/4", FH 2795.	2695.
MC1528-15	1345 Mb, 14.5ms, SCSI, 5-1/4", FH	.. 3995.	3895.

PC PAKS inc. controller/cables/mount hardware/software/manual

Maxtor® **\$249. \$339.**
Hard Drive Sale 40Mb, M7040A 80 Mb, M7080A

Tape Backup
Colorado Killer!!!
BACKTRAX Phantom 750 \$299.
 Twice the storage as Colorado...
 250Mb (internal). Reg. Retail \$379.

TOSHIBA Hard Drive
104Mb \$499.
 22ms, 3-1/2", HH, IDE, MK 234

Floppy Drives
 Toshiba TEAC

360K	5-1/4"	.. \$54.	\$59.
720K	3-1/2"	.. 59.	64.
1.2Mb	5-1/4"	.. 69.	74.
1.44Mb	3-1/2"	.. 69.	74.

Hard Drives • Card Drives • Tape Backups • Controllers
 Never a surcharge at ACP! Government, Institutional, OEM orders welcomed!



Advanced Computer Products, inc. MMC

1310 E. Edinger, Santa Ana, CA 92705 • FAX 714-558-1603 • Customer Service 714-558-1356 • Sales 714-558-8813
 We accept MC/VISA/AMEX, no surcharge for credit cards. Your card not charged until we ship. *Our 30 Day Guarantee does not refund shipping and handling charges. Drive must be in original package and in original undamaged condition, 1 Year replacement may have same restrictions. Prices and availability subject to change without notice. We ship FEDEX or UPS.

call your order toll-free 800-FONE-ACP



Circle 20 on reader service card

LPG

The Desktop Publishing Experts

& GRAPHICS

Order Toll Free (USA/Canada)
(800) 628-4517

International Orders
(301) 899-1118

24-HR Worldwide FAX Orders
(301) 899-1888

The Nation's Largest Dealer of Desktop Publishing & Multimedia Products ... Hours: M-F: 8:30 - 6pm Eastern Time, FAX ORDERS ANYTIME

Software

Aldus Persuasion for Windows	\$315
Charisma by Micrografix	349
Freelance Plus by Lotus	339
Harvard Graphics v3.0 (new version)	CALL
PageMaker 4.0 w/Adobe Type Manager for Windows	499
PowerPoint for Windows	329
Ventura Publisher v3.0	508

Fonts & Font Utilities

Adobe PostScript fonts	prices vary - please call
Adobe Type Manager	\$69
Adobe Type Align	69
Bitstream fonts	prices vary - please call
FontSpace (bitmap font compression)	58
Publisher's Typefoundry by Z-Soft	325
Soft Type by Z-Soft	118

Multimedia & "Print-to-Video"

Authoring Software	
ASK*ME System 2000 by ICS	\$299
IBM Storyboard Live v1.1	289
CD-ROM Disk Players	
NEC CDR-36 player & interface (external unit)	499
NEC CDR-73 player & interface (external unit)	699
NEC CDR-83 player & interface (internal unit)	699
CD ROM disk titles -- many to choose from	CALL
Computer Animation & Modeling	
Autodesk Animator	\$295
Autodesk Animation Player for Windows	129
Grasp 4.0	209
Computer Sound Recording & Audio Editing	
Sound Blaster audio card	\$159
Sound Blaster MIDI Bundle / Voice Editor	109 / 69
Jovian GLDR1A (CD-quality stereo digital sound)	CALL
NTSC Frame Grabbers / NTSC Digitizers	
Computer Eyes Color Professional	\$295
Computer Eyes RT (real-time frame grabber)	479
Jovian SuperVIA (16-bit color/8-bit gray realtime)	655
VIDEO LINX:Framebuffer (video in/out w/grabber)	499
Willow Publisher's Color (16-bit color realtime)	679
NTSC Encoders / Decoders / Genlock / Overlays	
Desktop TV (turns VGA monitor into a TV w/sound)	CALL
Jovian GENIE external scan converter (external unit)	CALL
Jovian VIN Plus NTSC encoder (external unit)	379
Willow VGA-TV GE/D (w/Video Titrer s/w)	645
Video Titling Software -- broadcast-quality titling	
Video Titrer by Entropy Engineering	375

Canon XAPSHOT
Still Video Computer Imaging Kit



Canon's XapShot still video camera lets you photograph anything and immediately transfer the image to a TV or into your computer. Use it to add pictures to your computer-based productions. It's as simple as any 35mm auto-exposure camera. The computer imaging kit comes with camera, accessory kit & frame grabber—everything you need. Let's you get CREATIVE !!!

XAPSHOT Color Imaging Kit	\$899
XAPSHDT camera only	445
XAPSHDT Lens attachments, disks, batteries	CALL
RC-470, FV-540, RV-301, RP-420 & other units	CALL

Video Monitors & Controllers

IDEK

IDEK MF-5117 17" flat screen color 1024 x 768 non-interlaced
Winner of PC Magazine's Editor Choice Award **CALL**

MONITERM

VIKING/3, full-page DTP monitor systems	
Viking 3/91M 20" monitor & controller	\$1399
Viking 3/2400M 24" monitor & controller	1999
Viking 3/72GS 20" grayscale monitor & controller	1999

NEC

NEC 3D / 3DS 14" 1024 x 768 color	\$659
NEC 4D 16" 1024 x 768 color monitor	999
NEC 5D 20" 1024 x 768 color monitor	2295
Multisync Graphics Engine-256 video board	899

SONY

CPD-1302 14" 1024 x 768 color interlaced	\$579
CPD-1304C 14" 1024 x 768 color non-interlaced	625
GVM-2000 21" Multimedia monitor w/ S-Video, A/V and RGB inputs, resolution up to 800 x 600	1449

High Performance Video Cards

ATI VGA Wonder 256-KB / 512-KB	199 / 239
Orchid Pro Designer II 512-KB / 1-MB	299 / 359
Sigma VGA Legend 512-KB / 1-MB	249 / 319
Video Seven VRAM II 512-KB / 1-MB	349 / 469
Video Seven 1024i 256-KB/512-KB	169 / 209

Hercules Graphics Station

Get the best 24-bit PC color video card. 16.7 million colors with resolution up to 1024 x 768. Uses the TI-34010 60-MHz graphics co-processor. Comes w/ Windows 3.0 driver, AutoCAO rel 10 & 11, and others. 2-year warranty.

1-MB ISA	\$675	3-MB ISA	\$985
1-MB MCA	CALL	4-MB MCA	CALL

SALE !!! PostScript Laser Printer Summer Time SALE !!!

QMS

PS-410 w/2-MB RAM, 45 fonts	1949
PS-410 w/3-MB RAM	2195
PS-410 w/4-MB RAM	2295
PS-410 w/5-MB RAM	2395
PS-410 w/6-MB RAM	2495

PS-815 Laser Printer	3495
PS-825 Laser Printer (2 paper trays)	4699

ColorScript 100 model 10	6495
ColorScript 100 model 30i (11" x 17")	CALL
ColorScript consumables	CALL

Big Bin paper feeders	CALL
RAM upgrades for printer memory	CALL

BEST OF 1990 — PC Magazine
1990 Eddy Award — MacUser

On-site service available for QMS and NewGen printers.
Call for details.

NEWGEN NewGen Systems Corporation

Hi-Res Personal PostScript Lasers (4-ppm)	
Turbo PS/300p (300 x 300 dpi)	CALL
Turbo PS/400p (400 x 400 dpi)	CALL

Hi-Res PostScript Laser Printers (8-ppm)	
Turbo PS/360 (600 x 300 dpi)	CALL
Turbo PS/400 (400 x 400 dpi)	CALL
Turbo PS/480 (800 x 400 dpi)	CALL

11 x 17 Hi-Res/Hi-Speed PostScript Lasers	
Turbo PS/600T (600 x 600 dpi)	CALL
Turbo PS/1200T (1200 x 600 dpi)	CALL



TEXAS INSTRUMENTS microLaser

microLaser (300-dpi, 6-ppm, HP LJ emulation)	\$989
microLaser PS-17 (PostScript, 17 fonts, 6-ppm)	1295
microLaser PS-35 (PostScript, 35 fonts, 6-ppm)	1569
microLaser XL PS-17 (PostScript, 16-ppm)	2595
microLaser XL PS-35 (PostScript, 16-ppm)	2895
1-MB SIMM memory upgrade	149

Laser Printer Upgrades

Adobe PostScript Cartridge HP LJII	CALL
Bitstream Type City font cartridge	CALL
Complete Font Library cart. for HP III & IIID	289
Pacific PostScript Cartridge PE	395
PacificPage XL accelerated Postscript cart.	899
25-in-One font cartridge	308
HP LaserJet 1-MB RAM upgrade, 5-yr warranty	105
HP LaserJet 2-MB RAM upgrade, 5-yr warranty	169
HP LaserJet 4-MB RAM upgrade, 5-yr warranty	239
EP-L Toner Cartridge for HP, QMS, etc.	75
EP-S Toner Cartridge for HP, QMS, etc.	85
Hi-Res Toner for NewGen, LaserMaster	175

Laser & Inkjet Printers

CANON	
BJ-10e bubblejet printer 360x360 max res	\$379
BJ-300 B0 column 360 x 360 max resolution	495
BJ-330 11" x 17" 360x360 max resolution	689
LBP-4 laser printer / with PostScript cartridge	879 / 1459
LBP-BT laser printer	1999
LBP-BR laser printer	2299
OKI DATA -- 5 year warranty on LED Printhead -- OKI DKI	
DL400 4-ppm, 300-dpi, 17 fonts, 512-KB RAM	\$695
OL800 (8-ppm, 300 dpi, 26 fonts, 512-KB RAM)	999
OL820 (8-ppm, 300-dpi, 26 scalable fonts, 512-KB)	1355
OL840 (8-ppm, 300-dpi, PostScript, 35 fonts, 2-MB)	1995
PANASONIC	
KX-P4420 (300-dpi, HP LJ emulation, 8-ppm)	\$795
KX-P4450i (300-dpi, HP LJ emulation, 11-ppm)	1195
KX-P4455 (300-dpi, 35-fonts, PostScript, 11-ppm)	1995

Color Printers

NEC	
ColorMate model 40, 300-dpi, 17 fonts	\$4695
ColorMate model 80 upgrade, 300-dpi, 35 fonts	CALL
DMS	
ColorScript 100 Model 10 8 1/2" x 11" PS	\$6495
ColorScript 100 Model 30i 11" x 17" PS	CALL
SEIKO INSTRUMENTS	
ColorPoint CH5504 A size bleed-to-edge	\$5259
ColorPoint CH5514 B size bleed-to-edge	7259
TEKTRONIX	
ColorQuick color inkjet printer. PostScript compatible, HP PaintJet compatible, 216-dpi resolution, 24-bit, 16.7 million color capability. Accepts paper or transparency media up to 12" x 18". Optional paper roll feeder.	\$1999

Digitizer Tablets, Mice & Trackballs

CALCOMP	
The WIZ with cursor	\$149
Pen option for the WIZ	64
KURTA -- corded or cordless pen & cursor systems	
IS/ONE B1/2" x 11" tablet, pen, cursor, drivers	\$329
IS/DNE 12" x 12" tablet, pen, cursor, drivers	358
IS/DNE 12" x 17" tablet, pen, cursor, drivers	599
SUMMAGRAPHICS	
Summasketch II 12" x 12" 4-button or 16-button	\$389
Summasketch II Pro 12" x 18" 4-button or 16-button	629
KENSINGTON	
Expert Mouse serial/bus	\$99/125
LOGITECH	
MouseMan serial (left handed or right handed mice)	\$75
MouseMan bus	79
MouseMan cordless mouse	145
TrackMan serial or PS/2	83
TrackMan Bus	89
WIGSOFT	
2-button mouse, 400-dpi resolution serial or bus	\$99

NEC Silentwriter2

PostScript / PCL Laser Printers

NEC 90	\$1595
NEC 990	CALL



MICROTEK TrueLaser

Complete compatibility! Microtek's new TrueLaser printer has Microsoft's TrueImage page description language plus PostScript and PCL compatibility. 35 fonts, auto-switching port selection, PC and Macintosh compatible, very fast first-page-out printing.

TrueLaser	\$1895
-----------	--------

TRUEPOINT

Call for price

TruePoint bundled with Canon LBP-4 Laser	CALL
TruePoint bundled with HP LaserJet III Laser	CALL

Roland Plotters/Sign Cutters

Professional-quality multi-color plotter / sign-maker & sign-cutter that's affordable for office, store, school and home. HP-GL compatible.

SketchMate A size Plotter	\$499
SketchMate Plotter/Sign Cutter	639
STIKA Scanner / Cutter	699
STIKA w/ SignMate s/w	899

DXY-1100 8-pen A size flatbed plotter	\$769
DXY-1200 8-pen A size flatbed plotter	1019
DXY-1300 8-pen A size flatbed plotter	1359
DPX-2500 8-pen/pencil, 1-MB, A-C size	3395
DPX-3500 8-pen/pencil, 1-MB, A-D size	4095

Call for other plotters not listed here

TruePoint from DP-TEK turns a Canon LBP-4 or HP LaserJet into a true 600 x 600 dpi PostScript-compatible laser! Halftones, line-art and type look photo-typeset. Simple to install. Fully compatible with all PostScript and EPS software. Adobe type 1 compatible, 35 fonts, etc.



EPSON ES-300C Scanner

24-bit, 16.7 million color scanner, one-pass scanning, 60-600 dpi resolution, 256-grayscale. Comes with scanner and interface. Bundled with Picture Publisher Plus, Image-In Scan, Paint & Plus modules, and ColorLab ES-300C software.

EPSON ES-300C Color Scanner	\$1659
-----------------------------	--------

Logitech Scanman 256 w/OCR (Special)

Hand-held, 256 gray levels. Bundled w/ Ansel software (Windows 3.0 compatible) and Catchword OCR software. While Supplies last \$295

Niscan GS for Windows 3.0

Hand-held, 256 gray levels. Bundled w/ Image In Scan, Paint and Plus (Windows 3.0 software) \$229

ProScan PS-3000 by OBM

Sheet-fed design (like a FAX machine). 16.7 million colors (24-bit), 256 gray levels. Bundled w/ Picture Publisher Plus image edit software & interface. \$699

PS-1000 grayscale scanner with Picture Publisher and interface \$399

Scanning Software & OCR

DCR (Optical Character Recognition)	
Caiera WordScan / WordScan Plus	\$399 / 665
Catchword DCR for Logitech hand scanners	189
DmniPage 386 Professional by Caere	685
ReadRight for Windows	339
ReadRight v2.01 for OOS	295
Scanner Software for Image Manipulation & Editing	
Deluxe Paint II Enhanced	\$99
Gray F/X by Xerox-Datacopy	295
IMAGE-IN COLOR (new version)	CALL
Picture Publisher Plus by Astral/Micrografix	469
Publisher's Paintbrush for Windows by Z-Soft	295
Tempra Pro v1.0 by Mathematica	359

MICROTEK COLOR SCANNERS

ScanMaker 600Z
600-dpi color/gray scanner. 16.7 million colors (24-bit) and 256 grayscale. Bundled w/PhotoStyler. Optional auto document feeder attachment available--ideal for OCR!!!

ScanMaker 600G \$CALL

ScanMaker 1850 35-mm Slide Scanner
1850-dpi, 16.7 million colors (24-bit) and 256 grayscale. Bundled with PhotoStyler. Scans slides and negative film.

600G for PC & PS/2	\$1099
--------------------	--------

ORDERING INFORMATION

Phone Orders (U.S. & Canada) (800) 628-4517
Phone Orders (International) (301) 899-1118
FAX Orders (24-hr service) (301) 899-1888
Customer Service (301) 899-1118

- > Purchase orders accepted. Call for approval.
- > COD's accepted with certified or cashier's check.
- > No surcharge applied when using your credit card.
- > Your credit card is not charged until we ship.

Mailing address: Laser Press & Graphics, 4888 Stamp Road, Marlow Heights, MD 20748 Make checks payable to Laser Press & Graphics. Returns require RMA, call for authorization. We do not guarantee compatibility. We reserve the right to change a 15% restocking fee. Returns must be in resalable condition. Software is not returnable if opened due to copyright laws. We reserve the right to limit quantities. Prices subject to change without notice. Thank You.

International Orders Our Specialty. We Use DHL International Air Service

1 STOP MICRO



WE'LL MEET OR BEAT ANY ADVERTISED PRICE!

60 Day Money Back Guarantee | 2 Year Parts & Labor | Free Shipping To/From On Any Product Serviced By Us

HARD DRIVES

Seagate

Model Name	Description	Price
ST228 (MFM)	45MB 28ms 3.5" hh ...	\$ 199
ST157R-1 (RLL)	49MB 28ms 3.5"	205
ST251-1 (MFM)	42MB 28ms hh	238
ST157A (IDE)	44MB 28ms 3.5"	205
ST1102A (IDE)	84MB 20ms hh	319
ST1144A (IDE)	125MB 20ms hh	415
ST1239A (IDE)	211MB 15ms 3.5"	699
ST2383E (ESDI)	337MB 15ms hh	1,295

All other Seagate models available.

Conner

CP3024 (IDE)	21MB 27ms 3.5"	\$ 230
CP3000 (IDE)	42MB 28ms 3.5"	250
CP3184 (IDE)	84MB 25ms 3.5"	410
CP30104 (IDE)	120MB 17ms 3.5"	465
CP3204 (IDE)	209MB 16ms 3.5"	710

Maxtor

XT4170E (ESDI)	157MB 14ms fh	\$ 745
XT4230E (ESDI)	203MB 16ms fh	855
XT8380E (ESDI)	360MB 14ms fh	1,175
7040A (IDE)	42MB 19ms 3.5"	230
7080A (IDE)	81MB 19ms 3.5"	345

FLOPPY DRIVES

TEAC

1.44MB 3.5" w/ kit	\$ 69
1.2MB 5.25"	69
360K 5.25"	59

POWER SUPPLIES

Super quiet! Super cool!

Desktop		Price
150/165 Watt XT	Fits Baby AT	\$ 38
200 Watt AT	Fits Full Size	48
230 Watt AT		55

Tower		Price
230 Watt AT	Fits Full Size	\$ 55
230 Watt XT/AT	Fits Mini Tower	55

KEYBOARDS/MICE

2001 101-Key Enhanced Click Style w/ Cover	\$ 55
Logitech C9 Serial/Bus Mouse	69/79
Genius Serial Mouse	23
Logitech Track Man	109
Logitech Scan Man Plus	195
OCR Software (for hand scanner)	79
OCR Software (deluxe version)	130

CASES

Desktop Cases *High quality!*

Baby Size AT 5-Bay Case	\$ 50
Full Size AT 5-Bay Case	52

Tower Cases

Mini-Tower w/ 200W PS	295
Full-Tower w/ 230W PS Digital Readout! ..	195

16 MHz 386SX VGA

Desktop 4 Bay Case	14" 640 x 480 Color Monitor
2 MB RAM	1 Parallel & 2 Serial Ports
1 2MB 5.25" Drive	101 Key Keyboard
40MB 17msec IDE Drive	16 Bit VGA (Upgradable to 512K)

\$1,500

20 MHz 386SX VGA

Desktop 4 Bay Case	14" 1024 x 768 Color Monitor
2 MB RAM	1 Parallel & 2 Serial Ports
1 2MB 5.25" Drive	101 Key Keyboard
40MB 17msec IDE Drive	16 Bit VGA w/ 512K

\$1,700

MEMORY

Intel

80287-8 Math Co-Processor	\$ 199	640K RAM	CALL
80287-10 Math Co-Processor	225	1MB DRAM 80/100/120 ns	CALL
80387SX Math Co-Processor	299	1MB SIPP Module 80ns	CALL
80387-25 Math Co-Processor	455	1MB SIMM Module 80ns	CALL
80387-33 Math Co-Processor	555		

VIDEO GRAPHICS

Video Boards Priced Fully Populated!

MONO Monographics w/ Printer Port	\$ 29
VGA AT/XT w/ Software	70
SVGA AT/XT (1024x768) 512KB	89
SVGA AT/XT (1024x768) 1MB VGA Card!	149
ATI Wonder Plus VGA	CALL
NEC Graphics Engine Board	910
Orchid Pro VGA 512KB	CALL
Paradise VGA Plus 16	185

MONITORS

NEC	Sony		
Multisync 2A VGA	\$ 460	CPD1320	\$ 465
Multisync 3D VGA	580	CPD1302	590
Multisync 4D VGA	995	CPD1304	625
Multisync 5D VGA	CALL	GVM2000	1,455

Samsung

MA-2565 12" Mono	\$ 75
MZ-4571 Flat Screen 14" Mono TTL	115
ML-4571 Flat Screen 14" Mono VGA	125
CJ-4685 VGA (640x480) 0.41 dot pitch 14"	275
CJ-4891 VGA (640x480) 0.31 dot pitch 14"	325
CSA7571 Syncmaster 4 color 17" Multiscan 0.31 (1024x768) Analog TTL	830

DISK CONTROLLERS

Western Digital

1006VSR2 (RLL) AT - 1:1 - 2 Hard/2 Floppy	\$ 99	IDE Disk Controllers	
1006VMM2 (MFM) AT - 1:1 - 2 Hard/2 Floppy	75	2 Hard/2 Floppy	\$ 28
XTGEN 2Plus (MFM) XT Card - Up to 2 Hard Disks	40	2 Hard/4 Floppy	38
1004A27X (RLL) XT Card - Up to 2 Hard Disks	49	2 Hard/2 Floppy w/ 1 Parallel, 2 Serial, and 1 Game!	48
		Floppy Controllers	
		XT/AT High Density Up to 4 Hi-Density Floppies!	33
		XT Floppy Controller	25

MODEMS

Smartlink 2400B Internal/External	\$ 79/89
Everex 2400B Int/Ext	90/159
Hayes 2400B w/ software Internal	279
US Robotics 2400B Int/Ext	130/150

PRINTERS

Hewlett Packard

We'll match any advertised PC World price!

Laserjet IIIIP	\$ 999
Laserjet IIP	919
Laserjet III	CALL
Laserjet IIID	CALL
Laserjet IIISI 17ppm 1MB	CALL
Desk Jet 500	CALL
Scan Jet Plus 320DPI w/ IBM interface ..	1499
Paint Jet Color Ink Printer (ser/parallel) ..	1525
Paint Jet XL	CALL

Accessories available, please enquire.

H-P Memory Compatible

IIP/IIIP 1MB	105
2MB	150
3MB	269
4MB	340
III 1MB	195
2MB	330

Citizen

GSX-140	CALL
GSX 145	CALL

All other models available.

Epson

LQ810 200cps 30NLQ	178
FX850 264cps, 54NLQ	295
LQ2550 400cps, 108NLQ	865
EPL6000	CALL

All other models available.

LAPTOPS

Toshiba

1000SE	\$ 999
1000XL/LE	CALL
1200XE 20MB/40MB	CALL
2000SX 20MB/40MB	CALL
3100SX	CALL
3100E 20MB/40MB	CALL
3200SX	CALL
5200 40MB/100MB	CALL

Laptop memory also available.

MOTHERBOARDS

With memory and CPU.

386-33 Mhz Cache 32-bit Power w/ 64K Cache! Full size board expandable to 16 Megabytes of Memory!	CALL
386-25 Mhz Cache 32-bit Power w/ 64K Cache! Baby sized motherboard expandable to 8 Meg	CALL
386SX-16 Mhz Up to 8 Meg - Baby sized	CALL

All other motherboards available, please call.

MULTI I/O

AT Card 2 Serial, 1 Parallel, 1 Game ..	\$ 20
XT Card 1 Serial, 1 Parallel, 1 Game, Clock, Calendar, and Battery	27
XT Plus 1 Serial, 1 Parallel, 1 Game, Clock, Calendar, w/ Battery	32
Intel/AST All models	CALL

TERMS AND CONDITIONS: NO SURCHARGE FOR MC OR VISA. TERMS: MC - VISA - COD - CASH - P.O.s FROM QUALIFIED FIRMS, 20% RESTOCKING FEE ON NON-DEFECTIVE RETURNS. PRICES SUBJECT TO CHANGE.



CALL NOW!
1-800-876-1786
 Circle 209 on reader service card

(818) 782-6691
Fax (818) 782-3202
Store Hours: Monday to Friday
7:30—5:00 Pacific Standard Time

MEMORY!



FIRST SOURCE INTERNATIONAL, INC.

"The Only Source for Computer Memory!"

WE ACCEPT INTERNATIONAL ORDERS AND PURCHASE ORDERS!
3 DAY INTERNATIONAL DELIVERY VIA FEDERAL EXPRESS, UPS, OR DHL!



YOUR CHOICE OF QUALITY MEMORY PRODUCTS MANUFACTURED BY: KINGSTON, PARAGON, AND APRICORN.

- ALL USER INSTALLABLE
- SUPERIOR SERVICE
- FREE TECHNICAL SUPPORT
- QUALITY PRODUCTS
- UNLIMITED SELECTION
- FLEXIBLE PAYMENT OPTIONS
- GREAT PRICES
- EXCEPTIONAL WARRANTY

FAX: 714-588-9872 or CALL: 714-588-9866

IBM MEMORY

PS/1		
512K Kit	1057035	\$79.00
2MB	IBM PN N/A	\$219.00
PS/2 30-2B6, Exp. Board 1497259		
512K Kit	30F534B	\$39.00
2MB Kit	30F5360	\$129.00
PS/2 70-E61/121,502,555X,655X		
1MB	6450603	\$69.00
2MB	6450604	\$139.00
PS/2 70-A21		
2MB	645060B	\$149.00
PS/2 55SX/LS, 65SX/LS, 34F3077 & 34F3011		
4MB	34F2933	\$299.00
PS/2 80-141		
1MB	6450375	\$99.00
PS/2 80-111/311		
2MB	6450379	\$159.00
PS/2 80-A21/A31		
4MB	6451060	\$289.00
PS/2 90, 95 and P75		
2MB	6450902	\$199.00
4MB	645012B	\$429.00
Expansion boards for all models 50 and 60		
2-BMB w/2M	1497259	\$399.00
2-16MB w/2M	6450609	\$429.00
Expansion boards for all models 70 and 80		
2-14MB w/2M	34F3077	\$399.00
4-16MB w/4M	34F3011	\$519.00

COMPAQ MEMORY

DeskPro 286-E,386-20/20E/25		
1MB	113131-001	\$109.00
4MB	113132-001	\$289.00
DeskPro 386S/16		
1MB	113646-001	\$119.00
4MB	112534-001	\$299.00
DeskPro 286N, and 386N		
OK Board	11B700-001	\$109.00
DeskPro 286N, 386N, 386SX/20		
1MB	11B68B-001	\$89.00
4MB	11B690-001	\$339.00
DeskPro 386N, 386SX/20		
2MB	11B689-001	\$149.00
DeskPro 386-33, 486-33 & SystemPro		
2MB	115144-001	\$149.00
BMB	116561-001	\$849.00
DeskPro 386-20e and 25e		
1MB Board	113644-001	\$179.00
4MB Board	113645-001	\$359.00
DeskPro 386S		
1MB Board	113633-001	\$189.00
4MB Board	113634-001	\$369.00
DeskPro 386/16 (Populate in this order)		
1MB Kit	10B071-001	\$129.00
1MB Board	10B069-001	\$289.00
2MB Board	10B069/71-001	\$389.00

LAPTOP MEMORY

COMPAQ	
Portable 386/20	1MB \$189.00
	4MB \$499.00
Portable LTE 286	1MB \$129.00
	4MB \$569.00
SLT-286	1MB \$159.00
	4MB \$579.00
SLT-386	1MB \$139.00
	2MB \$229.00
	4MB \$499.00
TOSHIBA	
1000SE, XE, LE, 2000SX	1MB \$139.00
	2MB \$249.00
	4MB \$539.00
1000LE, 2000SX	BMB \$1079.00
	2MB \$169.00
	2MB \$169.00
	2MB \$169.00
	4MB \$389.00
	2MB \$169.00
	4MB \$389.00
T1200XE	2MB \$169.00
T1600	2MB \$169.00
T3100E	2MB \$169.00
T3100SX	2MB \$169.00
	4MB \$389.00
T3200SX	2MB \$169.00
	4MB \$389.00

BRAND NEW!

IBM PS/2 140SX Laptop	
2MB	\$289.00
4MB	\$579.00
8MB	\$1149.00
Hewlett-Packard LaserJet IIIi	
1MB	\$89.00
4MB	\$329.00
Compaq LTE386/20	
1MB	\$399.00
4MB	\$649.00
NEC UltraLite 286F	
1MB	\$259.00
4MB	\$699.00
Toshiba T3200SXC	
2MB	\$179.00
4MB	\$399.00

WE WILL BEAT ANY ADVERTISED PRICE! - WHY CALL ANYONE ELSE?

PRINTER MEMORY

Hewlett Packard LaserJet IIP, III, IIIP and IIID		
2MB	33475B	\$149.00
4MB	33477B	\$249.00
Hewlett Packard LaserJet II and IID		
2MB	33444B	\$139.00
4MB	33445B	\$239.00
IBM Laser 4019 and 4019e		
2MB	1039137	\$169.00
3.5MB	103B675	\$249.00
Canon LBP-BII, 8IIR, 8IIT		
2MB	S63-1BB0	\$139.00
4MB	PN N/A	\$239.00
Panasonic 4450, 4450i and 4420		
2MB	KX-P441	\$169.00
4MB	PN N/A	\$269.00
Toshiba Page Laser 6		
2MB	LS6-NB0090	\$169.00
Okilaser 400, B00 and B20		
2MB	OKI PN N/A	\$169.00
Laser printer memory also available for:		
Texas Inst. QMS	Epson	Canon
Apple	Brother	AT&T
Konica	Star	Many others!

AST MEMORY

Premium 386C, 386/16		
1MB Kit	500510-007	\$69.00
Premium 386C, 386/16, FASTRAM, FASTboard		
4MB Kit	500510-00B	\$239.00
Premium 386		
1MB Kit	500510-003	\$89.00
4MB Kit	500510-004	\$269.00
Premium WS/386SX, WS/286, Brava 286,386SX		
2MB Kit	500510-002	\$129.00
Premium 386SX, 16,25,33,486 models		
1MB	500718-002	\$69.00
Brava 486/25		
2MB	500718-004	\$179.00
Premium II 386SX/20, SX/16, Cupid 32 card		
1MB	500780-003	\$79.00
4MB	500780-004	\$399.00
Premium 386/33T, 486/25, Brava 486/25		
BMB	500780-001	\$779.00

HEWLETT-PACKARD MEMORY

Vectra QS/16S & ES/12PC		
2MB Kit	D1354A	\$129.00
Vectra QS/16S and RS/20PC		
1MB Kit	D1540A	\$79.00
4MB Kit	D1542A	\$259.00
Vectra QS/20PC, RS/25PC, 20C and 25C		
1MB Kit	D1640A	\$79.00
4MB Kit	D1642A	\$259.00
Vectra 486 PC		
1MB Kit	D2150A	\$89.00
4MB Kit	D2151A	\$339.00
Vectra 486PC and 386/25 PC		
BMB Kit	D2152A	\$599.00
Vectra 386/25 PC		
2MB Kit	D23B1A	\$149.00

T3200SXC	2MB	\$179.00
	4MB	\$399.00
T3200	3MB	\$259.00
T5100	2MB	\$169.00
T5200,5200C,B500	2MB	\$169.00
	BMB	\$899.00

ZENITH

SlimsPart	1MB	\$199.00
Slims, SupersPort SX, 2B6E	2MB	\$199.00
Slims, SupersPort 2B6E	4MB	\$499.00
SupersPort 286, 2B6E	1MB Kit	\$129.00
SupersPart SX	2MB A or B	\$199.00

NEC

ProSpeed 286, 386SX/16	1MB	\$219.00
	4MB	\$569.00
PraSpeed SX/20	1MB	\$219.00
	4MB	\$529.00
ProSpeed 386	2MB	\$279.00
	BMB	\$1079.00
Powermate Portable SX	2MB	\$429.00
	8MB	\$1469.00

Many other brand name laptop and notebook memories available!

Panasonic	Sharp	Everex
Texas Inst.	Packard Bell	Sanya
Leading Edge	Hewlett Packard	AST

ZENITH MEMORY

Zenith Z-386/20/25/33 & 33E		
1MB	ZA36/3B00ME	\$79.00
4MB	ZA3B00MK	\$339.00
Zenith Z-386/20/25 & 33		
2MB	ZA3600MG	\$149.00
Zenith Z-386 SX and Z-386SX/20		
2MB Kit	Z-605-1	\$129.00
Zenith TurboSpart 386e		
1MB	ZA-3034-ME	\$199.00
4MB	PN N/A	\$569.00

EXPANSION BOARDS

Everex RAM 3000 Deluxe

Up to 3MB of base, expanded and/or extended memory. EMS 4.0 compatible with no wait states. Uses 256Kx1 Drom.

with 512K: \$139.00

BocaRam/AT Plus

Up to 8MB for any AT or 16 bit compatible machines running up to 33MHz. Offers all types of memory, provides a maximum of 8MB LIM/EMS 4.0. Uses 1x1 Drom or 1x9 SIMM modules.

2MB with DRAM's: \$239.00

2MB with SIMM's: \$259.00

NEC MEMORY

Powermate SX		
2MB Brd.	APC-HB55	\$569.00
4-BMB Brd	APC-H853	\$849.00
BMB Brd	NEC PN N/A	\$1429.00
Powermate SX Plus		
1-2MB Brd	APC-HB50E	\$239.00
2MB Brd	NEC PN N/A	\$399.00
4-BMB Brd	APC-B52E	\$669.00
Powermate SX/20		
2MB CPU	OP-410-8101	\$239.00
2MB CPU/OK	OP-410-8100	\$299.00
2MB Brd	OP-410-8102	\$239.00
2MB Kit	OP-410-8103	\$179.00
Powermate 386/20		
2MB Kit	APC-H655X	\$429.00
Powermate 386/25		
2MB	APC-H655E	\$429.00
BMB	APC-H656X	\$1329.00
BMB Base	APC-H657X	\$1329.00
Powermate 386/25S		
2MB Kit	OP-410-5201	\$239.00
BMB Kit	OP-410-5202	\$759.00
Powermate 386/33E and 486/25E		
2MB	OP-41-5101	\$299.00

TOLL FREE FROM ANYWHERE IN THE U.S. OR CANADA
ORDER NOW! 1-800-535-5892

WE ACCEPT VISA, MASTERCARD AND AMERICAN EXPRESS!



- No surcharge on Visa or Mastercard. AmEx add 4%.
- Terms: AMEX, Visa, Mastercard, C.O.D., P.O.'s.
- Return Policy: 20% Restocking fee on all non-defective returns and refused orders. All items must be returned within 15 days with original documentation and package. RMA# required.
- Manufacturers' part numbers are for your convenience, all products are third party. 100% compatible or full refund!
- Prices and availability subject to change.
- "We will beat any advertised price" valid only on identical brands offer not good for SIMMs or DRAM.

INT'L 011-714-588-9866
U.S. 800-535-5892
FAX 714-588-9872

MAIL ORDERS TO:

FIRST SOURCE INT'L INC.
36 ARGONAUT, STE 140
ALISO VIEJO, CA 92656

FOLLOW YOUR PACKAGE EVERY STEP OF THE WAY!



FAST, INEXPENSIVE AND DEPENDABLE DELIVERY ANYWHERE IN THE WORLD! CHOOSE THE CARRIER TO FIT YOUR DELIVERY NEEDS AT LOW RATES. INFORMATION FOR TRACKING SHIPMENTS IS READILY AVAILABLE AT YOUR REQUEST!

REPLACE YOUR CASH REGISTER!

Business Solutions for Retail Stores, Liquor Stores, Video Stores, Hair & Nail Salons, Auto Repair Shops, Rental Stores.



The Retail Controller (\$695) currently used by thousands of locations nationwide.

MicroBiz offers a complete one stop solution to computerizing your business. Leapfrog your competition, control your inventory, reduce shrinkage, billing errors, costs, and time with The MicroBiz Retail Controller Series.

Retail Controller Features...

- automatic credit card verification
- bar code compatibility
- color/size matrix
- multiple pricing levels
- track inventory by size/color/style
- mailing labels
- track customer history
- daily closeout reports
- accepts split tender
- view in-stock status
- pull down menus
- pop-up windows
- 99 levels of password protection
- tracks promotional sales
- prints bar code labels
- reorder reports
- extensive sales reports
- item/invoice discounts
- tracks sales by employees
- set limited-time promos
- links to One-Write Plus
- receiving reports
- pop-up calculator
- built-in word processor
- works on any IBM PC or compatible with hard disk drive
- multiuser and source code available
- dBase compatible compiled with Clipper...

***** DEALER INQUIRIES WELCOME *** 1-800-637-8268 *****



Maximize inventory, track detailed service history, guarantee repeat business, reduce billing errors, improve cash flow, schedule appointments, and produce reports for smarter business decisions.

Auto Repair Shop Controller \$1195



Imagine a computerized system that keeps in touch with your clients, sending out birthday cards, perm and color reminder letters, customer "thank you" notes...plus keeps complete financial control of your business!

Hair/Nail Salon Controller \$1195



This "beginner-proof" video retail management system is flexible enough to work in any location. Scan a bar code or key in video and membership information. Financial and rental information is always up to the minute.

Video Store Controller \$995



The CCD Bar Code Reader is a handheld non-contact device. It includes a "Y" cable and connects between the keyboard and computer...\$695.00

Bar Code Readers \$695



Multi-user for two or more stations. Used by thousands of growing liquor stores and chains nationwide. Monitor every sale, reduce theft, increase profits and meet the needs of your customers.

Liquor Store Controller \$1595

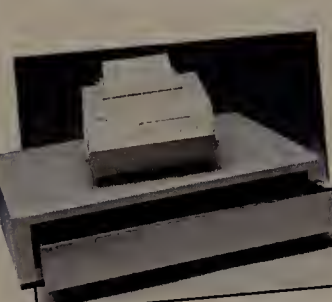

\$299 each purchased separately or \$595 as a combo package. Plugs right into your PC. The Star DP-8340 is a 40-column dot matrix receipt printer. The Cash Drawer is a sturdy steel electronic unit that opens with signals provided by all MicroBiz Controller products.

Cash Drawer/Printer Combo \$595



Free

Access files and programs on your office PC from home. CO/Session is fast, powerful and designed for the businessman on the go. With CO/Session and a modem, our MicroBiz support staff can see and operate your computer from our tech support department.

Co/Session Host FREE



One-Write Plus Accounting \$225

The MicroBiz Controller Series takes care of the day to day operations of your business. The One-Write Plus Accounting System (Winner, PC World's Best Buy Award) adds full accounting functions, General Ledger, Balance Sheets, Income Statements... to your system.

Circle 168 on reader service card



MicroBiz
500 Airport Executive Park
Spring Valley, NY 10977
Ph:(914)425-9500 Fx:(914)425-4598

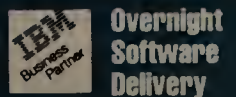

1-800-637-8268



MicroBiz . . . programming your business for success.



THE HOME OFFICE

The practical guide to home/office computing

Get the overalls, Honey, I'm doing it myself

Steve Bass

The old saying "The heart is willing, but the palms are sweaty" is only half true. My heart was pounding as well. I had decided to repair my old 286 clunker and discovered I could save almost \$500 by replacing the system board myself instead of taking it in for service. So I wiped the sweat from my palms and went at it.

Despite my early trepidation about venturing into unfamiliar territory, I discovered PC "repair" to be relatively straightforward. It took me only 4 hours—much of it spent fiddling with my CONFIG.SYS and AUTOEXEC.BAT files. I learned plenty about my computer, chose the system board I wanted, and even impressed my wife. And let's not forget I saved a few bucks.

I figured as long as I was popping the hood, I might as well install a faster engine. I wanted enough speed and memory to run *Windows* easily. After comparing the specifications of more than 20 different 386 boards, I decided on AMI's 386/486 Mark III Convertible because while I can only afford the 33-MHz 386DX version right now, I can upgrade with a 486 processor card later.

The Mark III with 4MB lists for \$1475, but nobody ever pays list price.

You can get one for about \$1200.

On the day of reckoning, I cleared the desk, turned on the answering machine, and opened my copy of Aubrey Pilgram's *Build Your Own 80486 PC and Save a Bundle*.

If you're doing it yourself, there are some precautions you *must* take. First, the obvious but most important: Unplug the computer before you take off the case. Controlling electrostatic discharge is essential. If you don't, you risk frying the system board or other components. I wore a \$3.79 antistatic wristband from Radio Shack. I also used Curtis's Touch Me First antistatic pad.

You'll need small Phillips and flat-



LINDA BLECK

blade screwdrivers plus a pair of needle-nose pliers. Tiny screws invariably drop from your fingers and hide under the floppy drive, so have a small flashlight handy and a pencil with a bead of Silly Putty at the point. I used one of those plastic boxes with all the compartments to hold the multitude of screws and system board brackets.

My anxiety peaked as I began working my way down to my old motherboard. There were dozens of wires and cables snaking from here to Taiwan. To avoid confusion, I had sketched out a

diagram of both motherboard assemblies *before* removing anything.

As I removed each add-in card, I noted where it came from on the old computer diagram and where it would go on the new one. I used masking tape and a felt pen to mark each wire and flat cable with a number, recording what it was connected to and the direction of the connector's pins. Ditto for the power supply, floppy drives, battery, speaker, reset button, and other components. If you can, leave the floppy and hard drives in their cages with the cables attached.

Two last screws, and the system board slid out. I removed the white plastic brackets, used them with the new system board, and reversed the entire procedure. After some minor tweaking with the SETUP program, I rebooted and—by golly, it worked.

While I'll never go into the repair business, I'm glad I took the risk. It was fun and, with the \$480 or so I saved on parts markup and labor, I got a faster computer with lots more memory. ●

Contributing Editor Steve Bass is a family therapist and president of the Pasadena IBM Users Group.

Mark III \$1475; American Megatrends, Inc.; 800/828-9264, 404/263-9381 (fax)
Reader service no. 607

Build Your Own 80486 PC and Save a Bundle \$26.95; Windcrest Books; 800/822-8158, 717/794-2191
Reader service no. 608

Touch Me First \$39.95; Curtis Manufacturing; 603/532-4123, 603/532-4116 (fax)
Reader service no. 609

For more information about all products in this article, circle reader service no. 902.

OUR CATALOG IS FREE. OUR COMPUTERS ARE JUST A LITTLE MORE.

Send for the brand new Dell product catalog,
loaded with information on all our award-winning
computers, service and support. Plus, get the details

on our newest line of PCs, laptops, note-
books and turbocharged servers.

Return this card today, or call us.

TO ORDER, CALL. PLEASE REFERENCE #11D38	
800-873-1130	
HOURS: 7AM-9PM CT MON-FRI 8AM-4PM CT SAT	
IN CANADA, CALL 800-387-5752. IN MEXICO 95-800-010-0664.	
DELL COMPUTER CORPORATION	

Mail this postage-free card and we'll send you the new Dell Catalog with information on our newest line of PCs, laptops, notebooks and turbocharged servers. You'll also find out about our award-winning service and our low prices, so return this card today, or call us at (800) 873-1130. In Canada, call (800) 387-5752. In Mexico, call 95-800-010-0664.

Please have a Dell Representative call me.

Name: (M) _____
(Please print)

Title: _____

Company: _____
(If Applicable)

Address: _____

City: _____ State: _____ Zip: _____

Type of Business: _____

Approx. # of Employees in Company: _____

Home Phone: (_____) _____

Business Phone: (_____) _____

Fax #: (_____) _____

1. Which products are you most interested in?

<input type="checkbox"/> 286-based systems	<input type="checkbox"/> UNIX [®] -based systems
<input type="checkbox"/> 386SX-based systems	<input type="checkbox"/> Laptops/Notebooks
<input type="checkbox"/> 386 [™] -based systems	<input type="checkbox"/> Other: _____
<input type="checkbox"/> i486 [™] -based systems	

2. Are you interested in computer products for:

Home Business Resale

3. If for resale, please identify your primary customers:

General Business Government Education Medical

4. How many PCs does your company plan to purchase in the next twelve months?

<u>Quantity</u>	<u>Timeframe</u>	<u>Quantity</u>	<u>Timeframe</u>
_____	Less than 1 month	_____	6-12 months
_____	1-3 months	_____	More than 12 months
_____	3-6 months		

5. What do you plan to use computer products for?

6. How many PCs do you have installed now at your company?

7. Are you interested in leasing? Yes No AD CODE 51D38

Mail this postage-free card and we'll send you the new Dell Catalog with information on our newest line of PCs, laptops, notebooks and turbocharged servers. You'll also find out about our award-winning service and our low prices, so return this card today, or call us at (800) 873-1130. In Canada, call (800) 387-5752. In Mexico, call 95-800-010-0664.

Please have a Dell Representative call me.

Name: (M) _____
(Please print)

Title: _____

Company: _____
(If Applicable)

Address: _____

City: _____ State: _____ Zip: _____

Type of Business: _____

Approx. # of Employees in Company: _____

Home Phone: (_____) _____

Business Phone: (_____) _____

Fax #: (_____) _____

1. Which products are you most interested in?

<input type="checkbox"/> 286-based systems	<input type="checkbox"/> UNIX [®] -based systems
<input type="checkbox"/> 386SX-based systems	<input type="checkbox"/> Laptops/Notebooks
<input type="checkbox"/> 386 [™] -based systems	<input type="checkbox"/> Other: _____
<input type="checkbox"/> i486 [™] -based systems	

2. Are you interested in computer products for:

Home Business Resale

3. If for resale, please identify your primary customers:

General Business Government Education Medical

4. How many PCs does your company plan to purchase in the next twelve months?

<u>Quantity</u>	<u>Timeframe</u>	<u>Quantity</u>	<u>Timeframe</u>
_____	Less than 1 month	_____	6-12 months
_____	1-3 months	_____	More than 12 months
_____	3-6 months		

5. What do you plan to use computer products for?

6. How many PCs do you have installed now at your company?

7. Are you interested in leasing? Yes No AD CODE 51D38

ORDER OUR FREE CATALOG NOW OR PAY THOUSANDS LATER.

For A Free Catalog Of
Dell's New Computers, Send This Card.

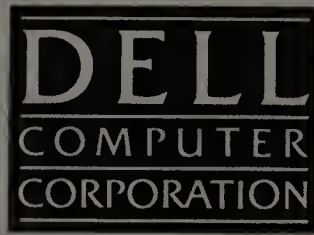

386 and i486 are trademarks of Intel Corporation. UNIX is a registered trademark of AT&T in the United States and other countries. ©1991 Dell Computer Corporation. All rights reserved.

NO POSTAGE
NECESSARY
IF MAILED
IN THE
UNITED STATES



NO POSTAGE
NECESSARY
IF MAILED
IN THE
UNITED STATES



BUSINESS REPLY MAIL

FIRST CLASS MAIL PERMIT NO. 6745 AUSTIN, TEXAS

POSTAGE WILL BE PAID BY ADDRESSEE

DELL COMPUTER CORPORATION
DEPT DH
9505 ARBORETUM BLVD
AUSTIN TX 78759-9860

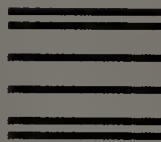

BUSINESS REPLY MAIL

FIRST CLASS MAIL PERMIT NO. 6745 AUSTIN, TEXAS

POSTAGE WILL BE PAID BY ADDRESSEE

DELL COMPUTER CORPORATION
DEPT DH
9505 ARBORETUM BLVD
AUSTIN TX 78759-9860





THE NEW DELL® 320SX 20 MHz i386™ SX SYSTEM.
SYSTEM INCLUDES VGA COLOR PLUS MONITOR,
40 MB HARD DRIVE AND 1 MB RAM.*

resolution video monitor, 40 MB hard drive and 1 MB of RAM.*

Just describe what you need and we'll custom configure it, build it, test it, and ship it to you. If you aren't satisfied after 30 days, you can send it back. No questions asked. But considering that our service and support program has won *PC Week's* Corporate Satisfaction Poll an unprecedented 8 times, that's highly unlikely.

So call us today.

And discover how much less you'll pay for our logo.

**THERE'S A BIG
DIFFERENCE BETWEEN
OUR 386SX PC AND
OUR COMPETITORS!**

**YOU PAY UP TO
\$1,000 LESS FOR
OUR LOGO.**

If you don't like the thought of needlessly spending an extra thousand dollars or so on an i386SX system, we have a suggestion for you. The Dell 320SX, for only \$1,999.

This new slim-line 20 MHz system offers the ability to run Microsoft® Windows,™ single-tasking MS-DOS®, multi-tasking MS® OS/2® or UNIX® and other PC networking systems.

It comes standard with a high

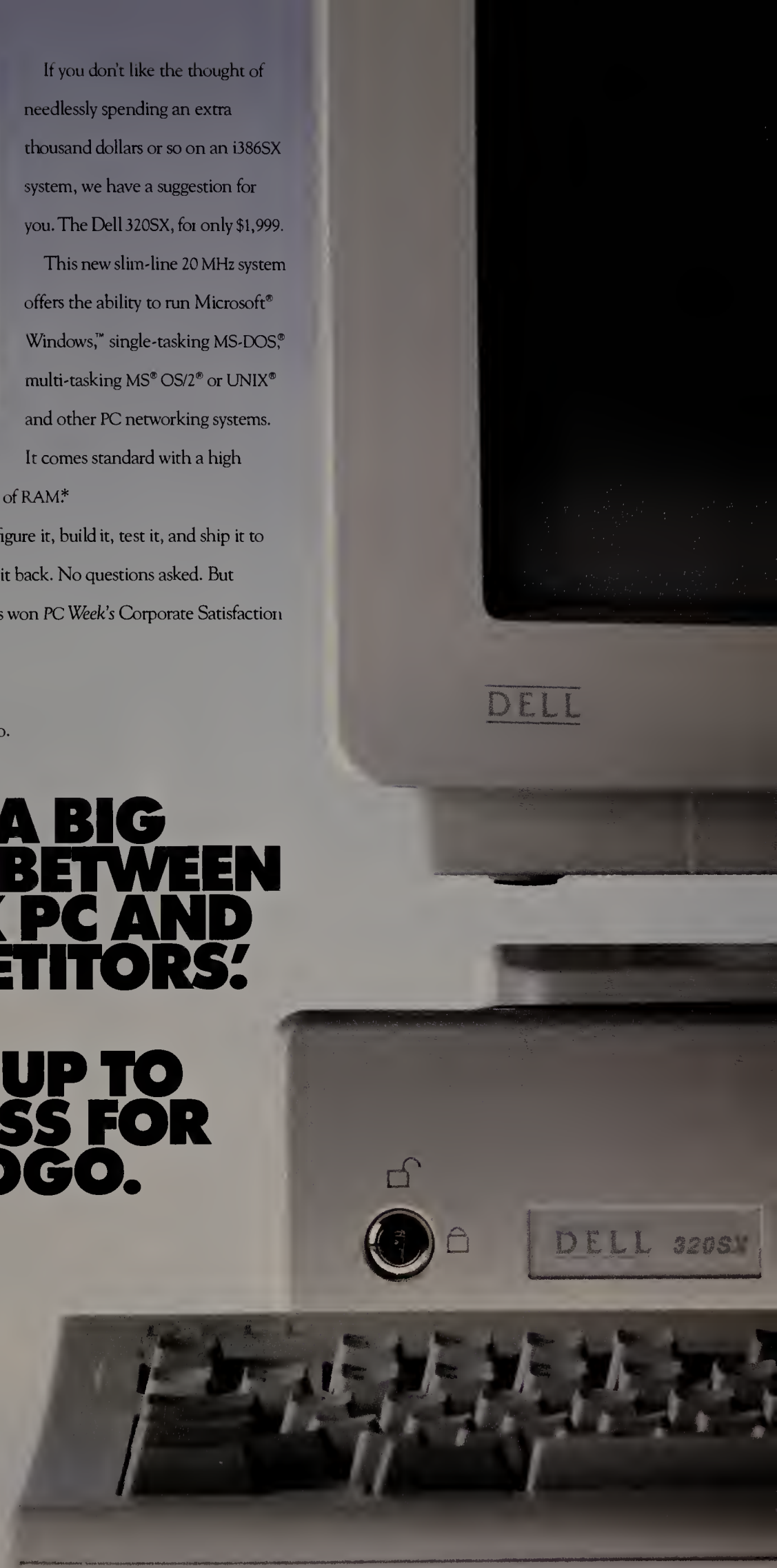

TO ORDER, CALL. PLEASE REFERENCE #11DH1.

800-626-4398

HOURS: 7AM-9PM CT MON-FRI 8AM-4PM CT SAT

IN CANADA 800-387-5752. IN MEXICO 95-800-010-0664.

DELL
COMPUTER
CORPORATION

This nagging recession has persisted for some time but now relief is finally in sight.

Because Dell has just reduced the prices on various 286, i386SX, i386 and i486™ desktops and i386SX laptops up to \$900. And although our prices are now extraordinarily low, our quality and reliability remain extraordinarily high.

Our service and support program isn't hard to swallow either. Dell's toll-free

technical support hotline solves 90% of reported problems over the phone, usually in 6 minutes or less. You can also get system information 24 hours a day via our innovative TechFaxSM line. Or log on to our electronic bulletin board that

lets you see other users' questions. And better yet, Dell's answers.

If this still doesn't clear up the problem, a trained technician will be at your desk-side usually by the next business day.△

This is all pretty easy to take when you consider Dell phone support is always free and the system price includes a one-year on-site service contract.

Perhaps this is why we come so high

HERE'S THE SUPPORT YOU'LL GET.

- ~ Toll-free technical support hotline for the life of your system.
- ~ One full year of on-site service included in the system price.△
- ~ Self-diagnostic software.
- ~ Toll-free 24-hour TechFax line for instant access to Dell technical information.
- ~ On-line Bulletin Board to communicate with Dell technical staff and other Dell users.

COUGH TOO TAKE ONLINE



DELL SYSTEM® 433P
WAS \$5,199
NOW ONLY \$4,299
Lease: \$156/month.**
• i486 microprocessor running at 33 MHz.
100 MB VGA Color Plus System \$4,299
Price listed includes 4 MB of RAM,* 200 and 320 MB hard drive configurations also available.



DELL SYSTEM 333D.
WAS \$3,399
NOW ONLY \$3,299
Lease: \$123/month.**
• Intel® 80386 microprocessor running at 33 MHz.
40 MB VGA Color Plus System \$3,299
Price listed includes 1 MB of RAM,* 80, 100, 200, 330 and 650 MB hard drive configurations also available. 25 MHz systems also available starting at \$2,699.



DELL SYSTEM
WAS \$2,499
NOW ONLY \$2,499
Lease: \$86/month**
• Intel 80386 microprocessor at 25 MHz.
40 MB VGA Color Plus System
Price listed includes 1 MB of RAM,* 80, 100, 200 and 320 MB hard drive configurations also available. 33 MHz systems also available at \$2,499.

*Performance Enhancements: Within the first megabyte of memory, 384 KB (433P), 128 KB (320SX, 316SX, 320L) and 64 KB (333D) is reserved for use by the system to enhance performance. Can be optionally configured for 256 KB (433P) or 128 KB (320L) of memory. **Leasing available in the United States and Mexico, configurations and prices may vary. Dell and Dell System are registered trademarks, TechFax is a trademark of Dell Computer Corporation. 1991 J.D. Power and Associates' Computer End User Satisfaction Study. Phase 1. J.D. Power and Associates is a service mark of J.D. Power and Associates. Intel is a registered trademark of Intel Corporation. UNIX is a registered trademark of UNIX Systems Laboratories, Inc. MS, MS-DOS are trademarks of Microsoft Corporation. Other trademarks are the property of their respective owners. Dell Computer Corporation disclaims any proprietary interest in trademarks and trade names other than its own. △Service provided by Dell Computer Corporation. May not be available in certain remote locations. Shipping, handling and applicable sales tax not included in the price.

recommended. Dell has won *PC Week's*
Corporate Satisfaction Poll for PCs,
laptops and servers an unprecedented
times.

You deserve

credit. Back to

this recession issue. If you don't want to
buy a Dell computer outright even at
these prices, just lease^o for as little as
\$1 a month. And we make available a
variety of financial products that can

be tailored to your business needs.

There's even a Dell Direct Advantage
MasterCard with a credit limit of up

to \$15,000 and a
way to earn points
toward Dell

products with everything you buy.

When you just can't take any more

high prices, call us. If you've had your

dose of high computer costs, this

is a perfect time to buy or lease one.

Just describe what you need and
we'll help you configure the right
system. Which we'll custom build, test
and ship to you with
a 30-day no ques-
tions asked money

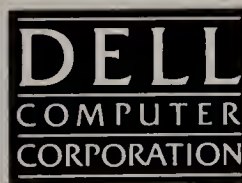

back guarantee and one-year limited
warranty.

So, call us today.

Because a deal like this is nothing to
sneeze at.

WING UP MUCH? OF THESE.



DELL SYSTEM 316SX.
WAS \$1,999

NOW ONLY \$1,799

Lease: \$68/month.**

• Intel 80386SX microprocessor
running at 16 MHz.
40 MB VGA Color Plus
System

\$1,799

Price listed includes 1 MB of RAM.*
20, 80, 100 and 200 MB hard drive
configurations also available.



DELL SYSTEM 320LT.
WAS \$3,699

NOW ONLY \$3,199

Lease: \$119/month.**

• Intel 80386SX microprocessor
running at 20 MHz.
40 MB, 1 MB RAM* \$3,199
20 and 120 MB hard drive
configurations also available.

16 MHz systems also available starting
at \$2,499.

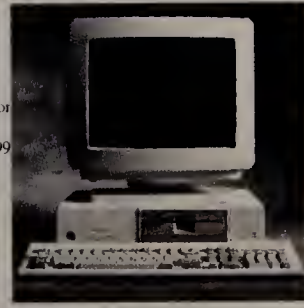

DELL SYSTEM 210.
WAS \$1,549

NOW ONLY \$1,349

Lease: \$51/month.**

• 80286 microprocessor running
at 12.5 MHz.
20 MB VGA Monochrome
System \$1,349

Price listed includes 1 MB of
RAM.* 40, 80 and 100 MB hard drive
configurations also available.



J.D. POWER AND ASSOCIATES JUST PUT US IN OUR PLACE.

J.D. POWER AND ASSOCIATES

PERSONAL COMPUTER CUSTOMER SATISFACTION RANKINGS*

1. Dell
2. Apple
3. AST
4. Hewlett-Packard
5. Everex
6. CompuAdd
6. Compaq
8. Epson
9. Toshiba
10. NEC

J.D. Power and Associates just released these results from the first ever industry Customer Satisfaction Index for Personal Computers, in Small and Medium Sized Businesses.™ And if you'll pardon any immodesty, we're proud to share them with you.

Computer users, in indicating their overall satisfaction, ranked Dell "Best Personal Computer in Customer Satisfaction in Small and Medium Size Businesses."™

While these results may surprise some people, it's not surprising to people who already own a Dell PC, notebook, laptop or server. Because satisfying our customers is how we've built a \$546 million business in just seven years.

Every step of the way, from the initial phone call, through the custom configuration of the computer, to service and support, our customers talk to us directly. For as long as they own the computer. And every inquiry our customers make is logged onto a special database. In the end, we know their system as well as they do. Maybe better.

So if you're impressed by these numbers, may we suggest you call the number below. And to find out more impressive facts about our service and support, just turn the page.

TO ORDER, CALL. PLEASE REFERENCE #11DH1.

800-626-4398

HOURS: 7AM-9PM CT MON-FRI 8AM-4PM CT SAT

IN CANADA 800-387-5752. IN MEXICO 95-800-010-0664.

DELL
COMPUTER
CORPORATION

Circle 74 on reader service card